

Tekla Structures 2022

Manage Tekla Structures

March 2022

©2022 Trimble Solutions Corporation

Contents

1	Manage Tekla Structures	9
1.1	Get started as a Tekla Structures administrator.....	9
1.2	Information sources for administrators	10
2	Tekla Structures installation for administrators.....	11
2.1	Installation requirements.....	11
2.2	Installing Tekla Structures.....	12
2.3	Installation files.....	12
2.4	Standard installation.....	13
2.5	Centralized installation.....	14
2.6	Installation in a virtual environment.....	14
2.7	Folder structure.....	14
2.8	Tekla Structures settings in the Windows registry.....	15
2.9	Installing an on-premises license server.....	16
2.10	Installing .tsep packages.....	16
2.11	Install .tsep packages directly.....	17
2.12	Install .tsep packages in Tekla Structures extension manager.....	17
2.13	Uninstall .tsep packages in Tekla Structures extension manager.....	18
2.14	Uninstall .tsep packages in Tekla Structures Extension Package (TSEP) builder and test runner.....	18
2.15	Installing .tsep packages centrally.....	18
2.16	Collaborative modeling.....	20
2.17	Upgrading Tekla Structures.....	20
2.18	Create start-up shortcuts with customized initializations.....	21
	Create a start-up shortcut with customized initialization.....	21
	Available parameters in shortcuts.....	23
	Example of an initialization file.....	24
2.19	Using Tekla Structures with application and desktop virtualization.....	25
	Prerequisites for using Tekla Structures in a virtual environment.....	26
	Set up the virtual environment for Tekla Structures.....	27
3	Manage Tekla Structures licenses	29
3.1	Tekla Structures on-premises licensing for administrators.....	30
	Checklist of Trimble deliverables needed in on-premises licensing.....	35
	Checklist of IT resources needed in on-premises licensing.....	36
	Checklist for the on-premises license server administrator.....	37
	Rights needed for administrator tasks in on-premises licensing.....	38
	Distributing and managing on-premises licenses.....	38

	Examples of different on-premises licensing setups.....	40
3.2	Installing Tekla on-premises license server.....	45
	Which on-premises license server version to use	46
	Install Tekla license server - automatic installation.....	47
	Install Tekla license server - manual installation.....	48
	Modify the license file tekla.lic manually.....	51
	Configure Tekla license server manually.....	53
3.3	Allowing Tekla on-premises license server to operate through Windows Firewall.....	54
	Allow exceptions in firewall for lmgrd.exe and tekla.exe.....	55
	Allow traffic in fixed TCP/IP ports.....	56
3.4	Activate on-premises licenses.....	65
	How license activation works.....	65
	Activate on-premises licenses using automatic server notification.....	66
	Activate on-premises licenses using manual server notification.....	68
3.5	Preconfigure license server settings for users.....	69
3.6	Deactivate on-premises licenses.....	70
	Deactivate on-premises licenses.....	71
3.7	Maintain Tekla licenses and subscriptions.....	72
	Monitor Tekla Structures license use.....	73
	Modify on-premises license access rights (tekla.opt).....	74
	Configuration codes and keywords used in access right definitions.....	76
	Move licenses between license servers.....	79
	Repair an on-premises license.....	80
	Troubleshoot Tekla licensing	81
	View and diagnose errors in Tekla Structures license activation, deactivation and borrowing.....	82
	Problems in Tekla license server installation and connecting to the license server	83
	Problems in FlexNet.....	85
	Problems in Tekla license activation.....	86
	Problems in Tekla license deactivation.....	90
	Problems in Tekla license borrowing.....	90
	Problems in Tekla license trusted storage.....	91
	Problems using LMTOOLS in Tekla licensing.....	92
	Problems in starting Tekla Structures.....	95
	Problems with options file tekla.opt.....	96
	Problems in Tekla licensing: Error codes and their descriptions.....	97
3.8	Set up on-premises license borrowing for offline use.....	104
	Provide offline users with a customized product ID file.....	106
	Set up Tekla License Borrow Tool for Tekla Structures offline use.....	107
	Borrow a license from on-premises license server.....	108
	Return a borrowed on-premises license.....	110
4	Implementation guide for administrators.....	111
4.1	Customizing Tekla Structures.....	111
4.2	Overview of environments, roles and licenses.....	113
4.3	Folder structure.....	114
4.4	Project and firm folders.....	115
4.5	Folder search order.....	116

4.6	Initialization files.....	117
4.7	Setting advanced options in .ini files.....	119
4.8	Creating shortcuts.....	120
4.9	Bypassing the login screen.....	121
4.10	User-defined attributes.....	122
5	Create and distribute customized settings, user interface elements, and catalogs	124
5.1	Environment, company, and project settings for administrators.....	126
	Environment settings.....	127
	Company settings.....	127
	Project settings.....	131
5.2	Distribute customized ribbons by using a firm or environment folder. 133	
	Add ribbons to a firm or environment folder.....	133
	Loading order of custom ribbons.....	133
	Naming convention for ribbon files.....	134
5.3	Distribute customized tabs by using a firm or environment folder.....	135
5.4	Distribute customized property pane layouts by using a project, firm, or environment folder.....	137
	Add a property pane layout file to a project, firm, or environment folder.....	137
	Search order of the customized property pane layout files.....	137
5.5	Distribute customized property pane settings by using a project, firm, or environment folder.....	138
5.6	Distribute customized toolbars by using a project, firm, or environment folder.....	138
5.7	Customize the material catalog.....	139
	Important buttons in the material catalog.....	140
	Add a material grade.....	141
	Copy a material grade.....	141
	Modify a material grade.....	142
	Delete a material grade.....	143
	Add user attributes to material grades.....	143
	Create user-defined material definitions.....	144
	Import and export material grades.....	145
	Import a material catalog.....	145
	Export an entire material catalog.....	146
	Export a part of the material catalog.....	147
5.8	Customize the profile catalog.....	147
	Important buttons in the profile catalog.....	148
	Group profiles together.....	149
	Add a rule to the profile catalog.....	149
	Modify a rule in the profile catalog.....	150
	Add user attributes to profiles.....	151
	Example: Add a user attribute to a profile and use it in a rule	151
	Associate profile types with a certain material.....	154
	Delete a profile from the profile catalog.....	155
	Import and export profiles.....	156
	Import profile catalog items.....	157
	Export an entire profile catalog.....	158
	Export a part of the profile catalog.....	158

	Example of profile export file.....	159
	Units used in import and export.....	161
	Import and export sketched profiles.....	162
	Create your own profiles.....	163
	Create user-defined cross sections.....	164
	Create fixed profiles.....	170
	Create parametric profiles using .clb files.....	173
	Create parametric profiles by sketching.....	181
	Create parametric profiles with variable cross sections.....	206
	Define standardized values for parametric profiles.....	209
	Create an image of a profile.....	210
5.9	Customize the shape catalog.....	211
	Import shapes.....	212
	Example: Import a shape from SketchUp Pro.....	214
	Compress shape geometry files.....	215
	Clean shape geometry files.....	216
	Create shapes.....	217
	Create a shape by using existing geometry in the model.....	217
	Create a shape by converting a part to an item.....	218
	Work with shapes and groups in the shape catalog.....	218
	Add a new group or sub-group.....	220
	Modify a group or sub-group.....	220
	Move or copy a group or sub-group.....	221
	Select shapes.....	221
	Preview a shape.....	222
	Move or copy shapes between groups.....	223
	Modify shape properties.....	223
	Delete a group or sub-group, or shapes.....	224
	Export shapes.....	224
	Organize the shape catalog view.....	226
	Show or hide the catalog ribbon.....	226
	Work with property columns in the catalog view.....	226
	Filter shapes.....	227
	Add stars to shapes.....	228
	Add tags to shapes.....	229
5.10	Customize the bolt catalog.....	229
	How the bolt catalog and bolt assembly catalogs work together	230
	Manage bolts and bolt assemblies.....	231
	Add a bolt to the catalog.....	231
	Add a stud bolt to the catalog.....	232
	Modify bolt information in the catalog.....	233
	Delete a bolt from the catalog.....	234
	Add a bolt assembly to the catalog.....	234
	Modify bolt assembly information in the catalog.....	235
	Delete a bolt assembly from the catalog.....	235
	Import and export bolts and bolt assemblies.....	236
	Import bolts to the catalog.....	236
	Export bolts from the catalog.....	237
	Import bolt assemblies to the catalog.....	237
	Export bolt assemblies from the catalog.....	238
	Import a bolt catalog.....	238
	Import a part of the bolt catalog.....	239
	Export an entire bolt catalog.....	240
	Bolt length calculation.....	240
	Bolt catalog properties.....	243

	Bolt assembly catalog properties.....	245
5.11	Customize the rebar catalog.....	246
	Work with definitions in the rebar catalog.....	247
	Add a new rebar definition.....	247
	Add a new rebar definition by copying.....	247
	Select rebar definitions.....	248
	Modify a rebar definition.....	248
	Delete rebar definitions.....	248
	Work with groups in the rebar catalog.....	249
	Add a new group to the catalog.....	249
	Modify a group in the catalog.....	250
	Delete a group from the catalog.....	250
	Import and export rebar definitions.....	251
	Import definitions to the rebar catalog.....	251
	Export definitions from the rebar catalog.....	251
	Organize the rebar catalog view.....	252
	Show or hide the catalog ribbon.....	253
	Change the grouping of rebar definitions.....	253
	Work with property columns in the catalog view.....	253
	Filter rebar definitions.....	255
	Add stars to rebar definitions.....	255
	Add tags to rebar definitions.....	256
5.12	Customize the Applications & components catalog.....	257
	Edit the catalog.....	257
	Maintain the catalog.....	262
	Troubleshooting components or groups in the catalog.....	262
5.13	Add instructor help for applications and components.....	263
6	Files and folders in Tekla Structures.....	265
6.1	Create project and firm folders.....	266
	Create a project or firm folder.....	267
	Fixed sub-folders in project and firm folders.....	267
6.2	Initialization files (.ini files).....	271
	Typical initialization files (.ini files) and their reading order.....	271
	Global default environment settings - env_global_default.ini.....	276
	Local environment settings - env_<environment>.ini.....	276
	Role settings - role_<role>.ini.....	277
	Add an advanced option to the user.ini file.....	277
6.3	File storing options and advanced options.....	279
	Settings in the Options dialog box.....	280
	Clash check settings.....	281
	Components settings.....	283
	Drawing dimensions settings.....	284
	Drawing objects settings.....	286
	General settings.....	287
	Load modeling settings.....	288
	Numbering settings.....	288
	Orientation mark settings.....	288
	Rebar set settings.....	290
	Units and decimals settings.....	292
	Settings defined by advanced options.....	299
	Change the advanced option values in the Advanced Options dialog box.....	301

6.4	Input files (.inp files)	302
	Properties of the objects.inp file.....	303
	Define and update user-defined attributes (UDAs).....	306
	Update definitions of user-defined attributes (UDAs) in a model.....	307
	Environment database file.....	308
	Example: Create and update a user-defined attribute (UDA).....	308
	Show plates as flat bars in drawings and reports.....	311
	Define flat bar sizes with the Fltprops.inp file.....	312
	Define unfolding parameters in the unfold_corner_ratios.inp file.....	313
6.5	Data files (.dat files)	316
6.6	Message files	317
	Customize message files.....	317
6.7	Property files	318
6.8	Standard files	319
6.9	Catalog files	322
6.10	Font files and font conversion files	324
6.11	Symbol files	325
6.12	Files related to templates, reports and drawings	325
6.13	Image files	326
6.14	Log files	327
	View a log file.....	331
	Change the name and location of session history log file.....	332
	Numbering history log file.....	333
	Numbering series in the numbering history log file.....	335
6.15	Model folder files and file name extensions	336
	Files in the Tekla Structures model folder.....	337
	Files in the \Analysis folder.....	340
	Files in the \attributes folder.....	340
	Component properties files in the \attributes folder.....	348
	Object level drawing settings, saved in \attributes folder.....	348
	View level drawing settings, saved in \attributes folder.....	349
	Files related to single-part drawings, drawing level properties, saved in \attributes folder.....	350
	Files related to assembly drawings, drawing level properties, saved in \attributes folder.....	352
	Files related to cast unit drawings, drawing level properties, saved in \attributes folder.....	353
	Files related to general arrangement drawings, drawing level properties, saved in \attributes folder.....	355
	Files related to multidrawings, drawing level properties, saved in \attributes folder.....	357
	Files common to all drawings, and files in the \drawings folder.....	358
	Files related to IFC export in \IFC folder.....	359
	Files related to NC in the \DSTV_Profiles folder.....	359
	Files in the \ModelSharing folder.....	359
	Files in the \ProjectOrganizer folder.....	359
	Files related to reports in the \Reports folder.....	360
	Files in the \SessionFileRepository folder.....	360
	Files related to shapes in the \ShapeGeometries and \Shapes folders.....	360
	Files in the \screenshots folder.....	360
	Files related to Unitech export in the \UT_files folder.....	361

6.16	Check and change Tekla Structures file and folder locations in Directory browser.....	361
6.17	Folder search order.....	362
6.18	Location of certain hidden files and folders.....	364
7	Templates.....	366
7.1	Create a template.....	368
7.2	Template Editor User's Guide.....	369
7.3	Create a template in HTML format.....	369
7.4	Create a .pdf report template.....	371
7.5	Create a template for nested assemblies.....	373
7.6	Create a template for bending schedules or pull-out pictures	377
	Bending schedule attributes.....	380
7.7	Add images in a template.....	382
7.8	Content types.....	384
7.9	Template attribute files (contentattributes.lst).....	387
7.10	User-defined template attributes.....	389
	Add user-defined template attributes to Template Editor.....	390
	Add comments to user-defined template attributes.....	392
	Add hierarchy to user-defined template attributes.....	392
7.11	Tips for templates	394
	Use text type attribute in calculations.....	394
	Change value field content to use imperial units.....	394
	Define customized date format.....	395
	Assembly or cast unit drawing sheet number.....	395
	Use format functions in value fields.....	396
8	Tekla Model Sharing and multi-user for administrators.....	399
8.1	Tekla Model Sharing.....	399
8.2	Multi-user models.....	400
9	Import Tekla Structures model and drawings into another model.....	402
10	Import user-defined attribute values.....	404
10.1	Input file structure.....	404
10.2	Data file (import_macro_data_types.dat).....	406
10.3	Examples of input files.....	408
10.4	Process an input file.....	409
11	Develop applications using Tekla Open API.....	411
12	Disclaimer.....	412

1 Manage Tekla Structures

Managing Tekla Structures means defining and maintaining the configurations and settings you require to complete your work in different projects.

Basic configuration for your own use is generally explained in the documentation of each feature. The customizations can be copied between different models and for this it is good to have a basic understanding of the [file and folder structure \(page 265\)](#).

If you manage Tekla Structures for other users, you are a Tekla Structures administrator, and you will need a deeper understanding and more managed approach to maintaining the configurations, settings and servers that your users need in their work. To start customizing Tekla Structures for your organization, read more below.

1.1 Get started as a Tekla Structures administrator

To get started as a Tekla Structures administrator, you familiarize yourself with the concepts related to installation, licensing and customization.

- Installation from the point of view of an organization's Tekla Structures administrator is explained in [Tekla Structures installation for administrators \(page 11\)](#).
- License administration tasks are explained in [Manage Tekla Structures licenses \(page 29\)](#).
- You can customize Tekla Structures extensively and distribute the customizations within your company. Basic customization tasks are explained in [Implementation guide for administrators \(page 111\)](#) and [Environment, company, and project settings for administrators \(page 125\)](#). See [Files and folders in Tekla Structures \(page 265\)](#) for more detailed information on the file and folder structure.

1.2 Information sources for administrators

Tekla User Assistance

Tekla User Assistance provides help information for all levels of users, including administrators. You can access the Tekla Structures help material in Tekla User Assistance by pressing the F1 button in Tekla Structures. If you have a dialog box open, Tekla Structures takes you straight to the related topic.

By default, all help content is online. Offline help installation packages are available in [Tekla Downloads](#). We recommend that you use the online help when possible as it is updated constantly.

The help is also available when Tekla Structures is not running. Depending on your Windows operating system, through the **Start** menu or **Start screen**, select the Tekla Structures <version> and click **Documentation**.

Release notes and Administrator's release notes

Release notes and Administrator's release notes are published in Tekla User Assistance for each new main and intermediate version of Tekla Structures. They contain very useful information that you can use when upgrading to a newer version of Tekla Structures.

Release notes contains information about the new features, improvements and fixes to existing features. Administrator's release notes contains useful information on how to localize and start using the new features in Tekla Structures.

Tekla Discussion Forum

[Tekla Discussion Forum](#) is a useful place to share experiences, ask questions, and discuss with advanced users. You need a Trimble Identity to log in.

Tekla Structures training

To use Tekla Structures to its full potential we strongly recommend users to attend training courses held by the local Trimble Solutions office or a reseller.

Your local support

If you have a valid maintenance contract, you can e-mail or phone your local support for help.

You can find the email address and phone number of your local support in [Tekla User Assistance](#) when you are logged in and your account is connected to your organization's group.

2 Tekla Structures installation for administrators

You can install Tekla Structures on a workstation using the standard installation packages or by creating your own centralized installation using MSI packages. You can also run Tekla Structures in a virtual environment.

If you have on-premises licenses, you must also install a license server on your own hardware.

2.1 Installation requirements

Trimble Identity

Tekla Online services, including online licensing, use Trimble Identity for identification. You can use your Trimble Identity with other Trimble services, such as Trimble Connect and SketchUp 3D Warehouse.

Each organization has at least one account administrator, who is responsible for managing the Tekla Online organization (group) used in Tekla Online services. Several people in your company can be administrators. The first user is invited by a Trimble representative, and that person is then responsible for adding other users and administrators as necessary.

As an administrator, you:

- Invite or approve employees to your company's Tekla Online organization to allow them unrestricted access in all Tekla Online services.
- Add external license users.
- Select who has access to your company's Tekla Structures subscriptions.
- Remove people from your company's employee group when they no longer belong to your company.

For more information, see [Create your Trimble Identity](#) and [Manage user accounts for Tekla products](#).

Tekla Structures installation prerequisites

For information about recommended operating system and hardware specifications, see Tekla Structures 2022 hardware recommendations.

Tekla Structures also requires some Microsoft redistributable packages. If these redistributable packages or newer versions of them are not already installed on your computer, they are automatically installed during the Tekla Structures software installation. For more information, see *Additional necessary software components* in the Tekla Structures 2022 hardware recommendations.

If you create a customized installation package, make sure that the .NET Framework is installed on the client computers.

In addition, the following installers are automatically installed during the Tekla Structures software installation:

- Tsep File Dispatcher Launcher
- Tekla Warehouse Service

These installers are needed for [Tekla Warehouse](#) to work properly.

Tekla Warehouse offline content is [available online](#). To find this content in Tekla Warehouse, search for **Catalogs** and under **Show**, select **Collections**.

2.2 Installing Tekla Structures

You can install Tekla Structures on each workstation running the standard installer separately on each workstation, or via a centralized installation with an MSI package and your preferred software deployment tool.

You can download Tekla Structures software and environments from [Tekla Downloads](#). To have the latest software in use, we recommend that you install the latest service pack of Tekla Structures. Service packs include improvements and fixes to the latest or to a previous main version or service pack of Tekla Structures. Service packs are available for all users with a valid maintenance contract or subscription.

NOTE You must install Tekla Structures with administrator rights.

When you do a centralized installation, the end users do not need administrator rights for the installation.

2.3 Installation files

Tekla Structures installers are `.msi` installers. Environment `.msi` installers include sets of `.tsep` installers that contain the actual environment files and settings. When installing a new version of Tekla Structures, install the software

first and then the environments. The `.msi` installers are installed to your computer before opening Tekla Structures.

When you run the environment `.msi` installer, the installer creates the environment folder and copies the `.tsep` installers to the `..\Tekla Structures\<version>\Extensions\To be installed` folder. The installer also creates the `RemoveEnv.bat` and `ToBeRemoved.txt` files, and places them to the `..\Environments\<environment>` folder. These files are used when uninstalling an environment.

When running the environment `.msi` installer, you can select in the installation wizard that the `.tsep` installers are run immediately when running the environment installer. If you do not select to do this, the `.tsep` installers are run when you open Tekla Structures for the first time after the installation. In this case, Tekla Structures opens a dialog box that shows the installation progress of the `.tsep` installers.

You can cancel the installation of extension `.tsep` installers in the dialog box and postpone them to the next Tekla Structures start-up. The queued environment `.tsep` installers are not canceled, they are installed even if you cancel. The `.tsep` packages contain information about the product type: environment or extension, which is used to determine which installers can be canceled.

Running the `.tsep` installers does not require administrator rights. The `.tsep` installers install the environment files to the `..\Tekla Structures\<version>\Environments\<environment>` folder.

If you are installing several environments for the first time, we recommend that you do not select to run the `.tsep` installers with the `.msi` installer. Some of the `.tsep` packages are used in more than one environment and the same version of a `.tsep` package is only installed once. Note that starting Tekla Structures for the first time after installation can take a long time particularly if you have installed several environments, as all the `.tsep` installers are run.

2.4 Standard installation

Tekla Structures installation wizard has detailed instructions about the installation.

For more information, see [Install and license Tekla Structures](#).

2.5 Centralized installation

Installing Tekla Structures centrally across the company network saves time in a large company when there are many Tekla Structures users.

Centralized installation allows you to run the Tekla Structures installation silently in the background so that the users do not see the installation wizard dialog boxes. For detailed information about centralized installation, see [Centralized distribution of Tekla Structures 2022](#).

2.6 Installation in a virtual environment

You can also run Tekla Structures in a virtual environment. Application and desktop virtualization allow users to run software from a server on the network without locally-installed Tekla Structures on their workstation. Using Tekla Structures from the server ensures that all users in a project are using the same project environment set-up. For detailed information about installation in a virtual environment, see [Using Tekla Structures with application and desktop virtualization \(page 25\)](#).

2.7 Folder structure

The default installation location is in `Program Files`. When Tekla Structures is installed in this folder, configuration files are installed in the hidden `Program Data` folder. This might be the preferred location for reducing the likelihood of end-user interference with the software installation and configurations.

If you install Tekla Structures in a normal file folder, all files are installed in that folder. Installing Tekla Structures in a normal file folder might be preferred for users who need to easily access all files.

Folder structure on local computer

See Tekla Structures installation folders in [Install and license Tekla Structures](#) for information about how the folder structure on the local computer is set up.

Company folder structure

If you use Tekla Model Sharing, you can synchronize the project and firm folders through the Trimble Connect cloud service included in your Tekla Structures subscription. .

If you have single-user or multi-user models, we recommend using a central file folder for storing the models and setup files for the company-specific settings and the project-specific settings. Tekla Structures then reads the settings from the central file server. For example, when upgrading to a new

Tekla Structures version or updating the company logo, the files only need to be replaced in one place. This way taking backups and upgrading is easier.

For more information, see [Create project and firm folders \(page 266\)](#).

Backup

With all valuable information and work your company stores, it is important to take backups of the model folders, and firm and project settings. If your company has a system for taking automatic scheduled backups, schedule your system to take the backups at night time, outside working hours to prevent any possible conflicts in the model.

If you use on-premises licenses, do not forget to also take a backup of the license entitlements and your active licenses.

Virus protection

Virus protection software has sometimes caused problems in saving models and drawings to the model folder. These problems might occur especially if you have your model saved on a network drive. We strongly recommend that you add Tekla Structures into the safe list of your antivirus system, and set up your virus protection in a way that actions in your model folder are not blocked or scanned.

2.8 Tekla Structures settings in the Windows registry

Windows registry is a hierarchical database that stores configuration settings and options in Microsoft Windows operating systems. Registry settings are used during a Tekla Structures session and during a Tekla Structures installation.

WARNING Do not change the registry settings. Changing the settings can cause the operating system to fail. It is possible to view the registry settings using the Registry Editor.

User settings

Some of the Tekla Structures user settings, for example, general options, and dialog box locations and sizes are stored in the registry. The settings are saved in a registry key named after the Tekla Structures version number in the registry branch `HKEY_CURRENT_USER\Software\Trimble\Tekla Structures\<VERSION>`.

Tekla Structures uses the hardcoded default settings when opened for the first time after the installation. If you change a setting during a Tekla Structures session, Tekla Structures saves the change during the session, or when you

exit Tekla Structures. When you open the same version of Tekla Structures again, the changed setting is used.

When upgrading to a newer Tekla Structures version, you can use the Migration Wizard tool to copy the settings you have changed.

Installation settings

The Tekla Structures installation saves information to the `HKEY_LOCAL_MACHINE\SOFTWARE\Trimble\Tekla Structures\<VERSION>` registry key.

2.9 Installing an on-premises license server

If you have on-premises licenses, you must install the license server on your own hardware. If you only use one license of Tekla Structures, you can install the license server on the same computer as Tekla Structures, making the license available on this one workstation. In an environment with multiple licenses and users, you install the license server in your company network, which allows for more flexible and efficient use of your licenses according to need.

Before users can start using Tekla Structures with on-premises licenses, you must:

- Install and set up a license server on a computer.
- Save the entitlement certificate and activate the licenses.
- Connect each client computer with Tekla Structures to the license server either manually, through a customized installation or by instructing the users.

For more information, see [Tekla Structures on-premises licensing for administrators \(page 30\)](#).

If you have Tekla Structures subscriptions, Tekla Structures always connects to Trimble's cloud service and you do not need to install your own license server.

2.10 Installing .tsep packages

Tekla Structures extension packages, `.tsep` packages, are Tekla Structures extensions or additional environment content installers. Extensions are not part of the Tekla Structures product release. `.tsep` packages are available for download in Tekla Warehouse.

You can install `.tsep` packages in three different ways:

- [Direct installation \(page 17\)](#)
- [Installation in Tekla Structures extension manager \(page 17\)](#)

- [Centralized installation \(page 18\)](#)

2.11 Install .tsep packages directly

TIP If the .tsep installer is not set to open with **Tekla Structures extension manager** by default, you can set it manually. Right-click the .tsep installer and select **Properties**. In **Opens with**, select **Change** and browse to `TsepFileDispatcherLauncher`.

1. Double-click the .tsep installer that you have downloaded.
The **Tekla Structures extension manager** dialog box opens with the name of the extension that is going to be installed.
By default .tsep installers are opened with **Tekla Structures extension manager**. Some .tsep installers are run directly from Tekla Warehouse with the **Insert into model** option.
2. Select the Tekla Structures versions to which you want to import and click the **Import** button. The next time you start Tekla Structures, the extension is automatically installed, and it is shown in **Tekla Structures extension manager**.

2.12 Install .tsep packages in Tekla Structures extension manager

You can install a .tsep installer from **Tekla Structures extension manager** in Tekla Structures.

TIP In **Extension manager**, you can list the extensions by type: extension or environment. You can also search for content based on name, author, description, and type of extension.

1. In the **Applications & components** catalog, click  > **Manage extensions** --> **Extension manager** .
2. Click **Import** and browse to the .tsep installer that you want to install.
3. Click **Open**.

The imported .tsep is installed the next time you start Tekla Structures. It is shown in **Tekla Structures extension manager**, and is ready for use in the **Applications & components** catalog.

2.13 Uninstall .tsep packages in Tekla Structures extension manager

1. In **Tekla Structures extension manager**, select the .tsep packages that you want to uninstall.
Use **Ctrl** or **Shift** to select more than one .tsep package.
2. Click **Remove**.

The .tsep packages are removed when you restart Tekla Structures.

2.14 Uninstall .tsep packages in Tekla Structures Extension Package (TSEP) builder and test runner

1. To open the **Tekla Structures Extension Package (TSEP) builder and test runner** dialog box, browse to `..\Program Files\Tekla Structures\<version>\bin\` and double-click `TeklaExtensionPackage.Builder.exe`.
2. On the **Uninstall TSEP based extensions** tab, select the .tsep packages that you want to uninstall, then click **Uninstall selected**.
Use **Ctrl** or **Shift** to select more than one .tsep package.

The selected .tsep are removed. You do not need to restart Tekla Structures.

2.15 Installing .tsep packages centrally

You can centrally install a batch of .tsep installers across company workstations. This method is meant for system administrators.

By default, the .tsep installers waiting for installation are stored in `\ProgramData\Trimble\Tekla Structures\<version>\Extensions\To be installed`. To install centrally, copy the .tsep installers to the `%XSDATADIR%\Extensions\To be installed` folder. If the folder does not exist yet, create it.

When Tekla Structures starts, it checks the available .tsep installers from the `\To be installed` folder and installs them automatically. If there is an older version of the same extension package, it is uninstalled before installing the new version. Installation is canceled if the same or newer version has already been installed.

- The installed .tsep installers are stored in the `%XSDATADIR%\Extensions\Installed` folder.

- Invalid .tsep installers are uninstalled and moved to the %XSDATADIR%\Extensions\Invalid installations folder.
- Canceled .tsep installers are stored in %XSDATADIR%\Extensions\Cancelled installations.

Copying .tsep installers

We recommend that you use ROBOCOPY from the command prompt (cmd.exe) to copy the .tsep installers. You can find more information about ROBOCOPY on the Microsoft website.

The basic syntax for ROBOCOPY is: `robocopy <Source> <Destination> [<File>[...]] [<Options>]`

For example, to copy .tsep installers in Tekla Structures 2022:

```
robocopy
"\\Server1\prod\TeklaStructures\2022.0\Environments_TSEP"
"C:\ProgramData\Trimble\Tekla Structures\2022.0\Extensions\To be
installed"
*.tsep
"C:\Program Files\Tekla Structures\2022.0\bin
\TeklaExtensionPackage.TepAutoInstaller.exe"
2022.0 "C:\ProgramData\Trimble\Tekla Structures\2022.0" "2022"
```

This command copies all .tsep installers from the \Server1 network directory to the local user's \To be installed folder. After copying, TepAutoInstaller.exe installs all .tsep installers from the local user's \To be installed folder. Installing the packages allows users to start Tekla Structures without first waiting for the installations to complete.

```
Administrator: C:\Windows\system32\cmd.exe
C:\Users\nduc1u>
C:\Users\nduc1u>robocopy \\Server1\prod\TeklaStructures\2017\Environments_TSEP C:\ProgramData\Tekla Structures\2017\Extensions\To be installed
*.tsep
ROBOCOPY      ::      Robust File Copy for Windows
-----
Started      : Wed May 18 09:54:09 2016
Source       : \\Server1\prod\TeklaStructures\2017\Environments_TSEP\
Dest        : C:\ProgramData\Tekla Structures\2017\Extensions\To be installed\
Files       : *.tsep
Options     : /COPY:DAT /R:1000000 /V:30
-----
100Bc      New File      3      \\Server1\prod\TeklaStructures\2017\Environments_TSEP\
                               81.3 n      Env_UK_Test.tsep
-----
Dirc :      Total      Copied      Skipped      Mismatch      FAILED      Extras
Files :      1          0          1          0          0          0
Bytes : 153,47 n      81.31 n      72.16 n      0          0          0
Times : 0:00:00      0:00:00
-----
Speed      :      10512094 Bytes/sec.
Speed      :      6015.706 MegaBytes/min.
Ended      : Wed May 18 09:54:10 2016
C:\Users\nduc1u>
```

Uninstalling .tsep packages centrally

You can uninstall .tsep packages in batches by creating an empty file without an extension, with the name RemoveExtensionOnStartup, in \ProgramData\Trimble\Tekla Structures\<<version>\Extensions\Installed\[Extension_To_Be_Uninstalled]. The extensions are removed the next time Tekla Structures is started.

2.16 Collaborative modeling

Several people can simultaneously work in the same Tekla Structures model.

If your company takes part in external projects, or if more than one user works with the same model at different locations, we recommend that you use Tekla Model Sharing. With Tekla Model Sharing, the users in your company can work with the same shared model, offline and with high performance, and synchronize the changes with other team members even in a low-speed network.

If you work in a local team and prefer not to use Internet while working on your models, you can use the multi-user mode.

For model coordination and exchange of other project files, we offer Trimble Connect. To find out more and set up collaboration in your organization, see [Tekla Model Sharing and multi-user for administrators \(page 399\)](#) and Working collaboratively within a Tekla Structures model.

Using the multi-user server requires your company to have more than one Tekla Structures license.

2.17 Upgrading Tekla Structures

You can install service packs on top of the existing installation of Tekla Structures. You can update to new service packs without updating the existing on-premises licenses. A new Tekla Structures version installs as a separate instance and can exist on the same workstation with other Tekla Structures versions. An update to a new version requires that you also update your on-premises licenses, as the licenses have a highest allowed version. Tekla Structures subscriptions automatically allow you to use any Tekla Structures version that is released during your subscription period.

If you already have an older version of Tekla Structures installed on your computer, you can use Migration Wizard to copy the personal settings to the new version. With the Migration Wizard you can choose to copy any of the following settings and values:

- `user.ini` file
- Registry values, such as:
 - Toolbars
 - Dialog boxes
 - General options

Migration Wizard does not copy the environment `.tsep` files which are installed by the environment installers.

When you customize Tekla Structures, for example, add or change drawing or report templates and catalog entries, we strongly recommend that you create project and firm folders for the customized files. This is useful if you want to store the files for future use, or if you want to retain them when you install a new release.

Tekla Structures does not replace files in the project and firm folders when you install a new release. You can retain your customized files without having to copy and paste, or export and import from the previous versions. This makes upgrading faster and easier. If you have customized previous Tekla Structures versions without using firm or project folders, you must transfer the customized information to the next Tekla Structures version.

Before you start using a new Tekla Structures version, always test that the old company settings work.

TIP If you want to copy the settings later, you can start Migration Wizard manually by double-clicking the `MigrationWizard.exe` in the `\Tekla Structures \<version>\bin\applications\Tekla\Migrations` folder. You can select the version from which the settings are copied and the version to which the settings are copied.

2.18 Create start-up shortcuts with customized initializations

You can use shortcuts to start `teklastructures.exe` with customized initializations. You can use this functionality to create shortcuts for different purposes, for example, to have customized setup files depending on the client you are working for in a project. The Tekla Structures installation automatically creates shortcuts for the selected environments.

NOTE We recommend that only administrators create the customization and the necessary shortcuts. Otherwise, your settings may differ from the settings defined for your firm, or for the particular project you are working for.

Create a start-up shortcut with customized initialization

1. Open the `user.ini` file using any standard text editor.

The `user.ini` file is located in `..\Users\<user>\AppData\Local\Trimble\Tekla Structures\<version>\UserSettings` on your computer.

2. Save the file with a new name, for example, `customer.ini` or `project.ini`.
3. Modify the file by adding the required settings.

4. Save the modified initialization file.
5. Right-click **Tekla Structures <version>** shortcut on your desktop and select **Copy**.
6. Paste the shortcut to your desktop.
7. Select the shortcut, right-click and select **Properties**.
8. Modify the **Target** of the shortcut by adding the required project initialization information to it.

First enter the path to the current `teklastructures.exe`, then the desired parameters.

Use the quotation marks (") in the path to avoid possible problems if the path contains spaces. If you have installed Tekla Structures to a path that does **not** contain spaces, there will be no problems even if you remove the quotations marks, for example, `C:\TeklaStructures\`. If you have installed Tekla Structures to a path that contains spaces, the quotation marks are needed, for example, `C:\Program Files\Tekla Structures\`.

Target type: Application

Target location: bin

Target:

Start in:

Shortcut key:

Run:

Comment:

The maximum length of a shortcut is 256 characters. If you have problems with the length, you can call all other necessary initialization files from your customized initialization file instead of adding them to the shortcut.

9. To override the settings defined in the shortcuts, use the parameter `-i <initialization_file>` in the `user.ini` and `option.ini` files.

Available parameters in shortcuts

The table below lists the parameters you can use in the start-up shortcuts.

The parameters can be used in combinations. You can set the parameters to automatically bypass the **Tekla Structures - Choose setup** dialog box, open a model and run a macro, for example.

Parameter	Description
-I <ini_file_path >	<p>The given .ini file is loaded before the environment .ini files. This parameter can be specified multiple times.</p> <p>This parameter can be used to bypass the Tekla Structures - Choose setup dialog (the login dialog).</p> <p>Example:</p> <pre>"C:\Program Files\Tekla Structures\<version>\bin\TeklaStructures.exe" -I "C:\ProgramData\Trimble\Tekla Structures\<version>\Environments\uk\Bypass.ini"</pre>
-i <ini_file_path >	<p>The given .ini file is loaded after the role .ini files. This parameter can be specified multiple times.</p> <p>Example:</p> <pre>"C:\Program Files\Tekla Structures\<version>\bin\TeklaStructures.exe" -i "C:\TeklaStructures\MySettings.ini"</pre>
To open an existing model <model_path>	<p>The given model is opened after start-up.</p> <p>Example:</p> <pre>"C:\Program Files\Tekla Structures\<version>\bin\TeklaStructures.exe" "C:\TeklaStructuresModels\My model"</pre>
To open an existing, autosaved model <model_path> / autosaved	<p>The given autosaved model is opened after start-up.</p> <p>Example:</p> <pre>"C:\Program Files\Tekla Structures\<version>\bin\TeklaStructures.exe" "C:\TeklaStructuresModels\My model" /autosaved</pre>
To create a new model without a model template / create:<model_path>	<p>A new model is created after start-up.</p> <p>Example:</p> <pre>"C:\Program Files\Tekla Structures\<version>\bin\TeklaStructures.exe" /create:"C:\TeklaStructuresModels\My model"</pre>

Parameter	Description
<p>To create a new model using a model template</p> <pre>/ create:<model_path> / modelTemplate: <template_name ></pre>	<p>A new model using a model template is created after start-up.</p> <p>Example:</p> <pre>"C:\Program Files\Tekla Structures\<version>\bin \TeklaStructures.exe"/ create:"C:\TeklaStructuresModels\My model" / modelTemplate:"Cast-in-Place"</pre>
<p>To create a new multi-user model</p> <pre>/ create:<model_path> / server:<server_name></pre>	<p>A new multi-user model is created after start-up.</p> <p>Example:</p> <pre>"C:\Program Files\Tekla Structures\<version>\bin \TeklaStructures.exe"/ create:"C:\TeklaStructuresModels\My model" / server:"my-server:1234"</pre>
<p>To run a macro after start-up</p> <pre>-m <macro_file_path></pre>	<p>The given macro is executed after start-up.</p> <p>The example below opens Tekla Structures, sets the environment, role and configuration from the Bypass.ini file, opens the model, and reads in and saves the model by using the Example Macro: Model Sharing Read in and Save from the BIM Publisher tool that is available in Tekla Warehouse.</p> <pre>"C:\Program Files\Tekla Structures\<version>\bin \TeklaStructures.exe" -I "C:\ProgramData\Trimble \Tekla Structures\<version> \Environments\<environment>\Bypass.ini" "C:\TeklaStructuresModels\<model>" -m "C:\ReadInSave2016.cs"</pre>

Example of an initialization file

Below is an example of a customized project initialization file that calls other initialization files.

```
MyProject.ini
//The project is based on the default UK settings
call C:\ProgramData\Trimble\Tekla Structures\2019.0\Environments\uk
\env_UK.ini
//...but our company policy requires these changes
call c:\CompanySettings\OurPolicy.ini
//..and the fabricator requires something
call c:\Fabricators\Fabricator1.ini
//..and then we let users to make some changes (color etc.)
call c:\Users\user_%USERNAME%.ini
```

The project shortcut for this initialization file:

```
"C:\Program Files\Tekla Structures\<version>\bin\TeklaStructures.exe" -i  
"\\MyServer\MyProject\MyProject.ini" "\\MyServer\MyProject\MyModel\"
```

2.19 Using Tekla Structures with application and desktop virtualization

Using Tekla Structures together with Citrix Virtual Apps and Desktops with Azure is a flexible and safe way to quickly add users to Tekla Structures projects without locally installing Tekla Structures.

This image shows the main concepts in Tekla Structures virtualization.

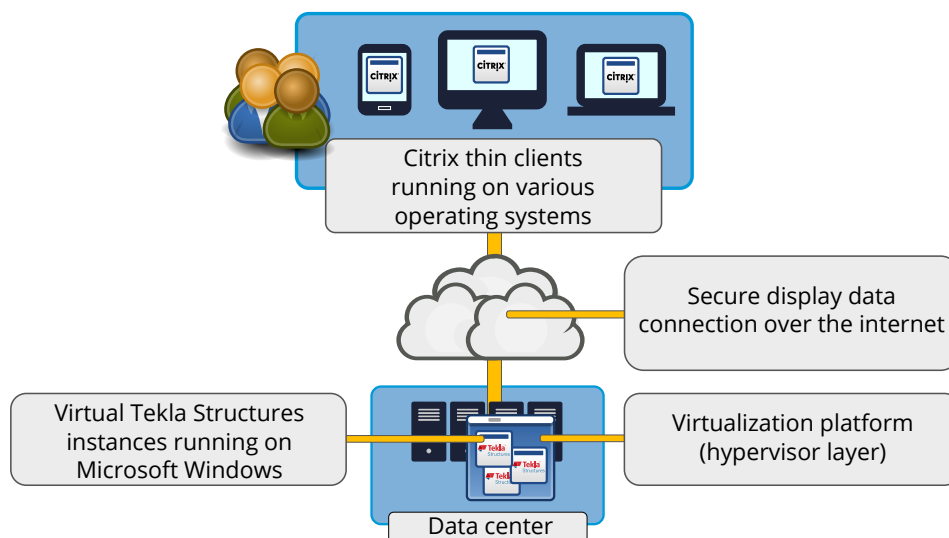

Citrix application and desktop virtualization products are products of Citrix Systems, Inc.

Streaming applications from the server makes it possible to use Tekla Structures on client computers, tablets, and smartphones that have different hardware and software configurations. Tekla Structures runs on Windows on the remote server and the virtualization solution allows client devices to be used for display and user input.

Users connect through a secure connection to the data center. The project data is stored only on the server. Using Tekla Structures from a centralized location ensures that all users in the project are using the same project environment.

Prerequisites for using Tekla Structures in a virtual environment

We recommend using Citrix Virtual Apps and Desktops with Azure for Tekla Structures virtualization. For more information, see [Citrix Virtual Apps and Desktops with Azure](#).

This image shows the main components in Tekla Structures virtualization.

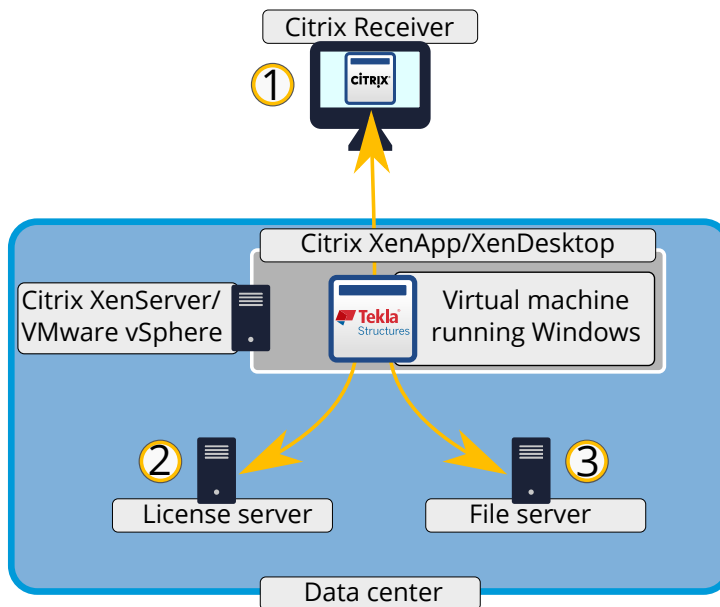

1. Users can access Tekla Structures using a thin client application, such as Citrix Receiver. Users can use Citrix XenApp client or Citrix XenDesktop desktop viewer on any supported operating system and hardware. Multiple concurrent clients can share one virtual machine instance.
2. Each `TeklaStructures.exe` running in the virtual environment must have a valid license.

If you use on-premises licenses, you can use a local, enterprise, or cloud Tekla license server. The license server can be hosted in the data center or outside of the data center.

3. Read and write project files from network-attached storage (NAS). Fast disk access is required.

Never store models on the local disk of the virtual server. Store project data, including environments, on another server in the data center or on a file system inside the company network.

Because accessing files from the client's local file system can be slow, we recommend that you avoid accessing files from the client's local file system as much as possible.

Set up the virtual environment for Tekla Structures

Set up the server, define delivery groups, and install the Tekla Structures software and environments on the server. Ensure that Tekla Structures users install the Citrix Receiver on their computers.

After setting up the virtual environment, you can use Tekla Structures on the virtual desktop in the same way as if it was installed on your own computer.

When you use the virtual desktop for the first time, you can give read and write access to your local files in the file access dialog box. Giving access to your local files has the following limitations:

- Referencing local files from your computer directly in Tekla Structures is not recommended. If you need to access those files in Tekla Structures, copy them to a shared network location first.
- Model folders are not copied to the client computers.

The Citrix Receiver client is updated frequently. Always install the latest client when the web user interface prompts you to do so.

1. Set up the server.

We recommend deploying Tekla Structures using Citrix Virtual Apps and Desktops with Azure.

For more information, see [Citrix Virtual Apps and Desktops with Azure](#).

2. Install Tekla Structures software and environments on the server.

Never store models on the local disk of the virtual server. Store project data on another server in the data center or on a file system inside the company network. Select the correct network location for the model folder during the Tekla Structures installation.

Tekla Structures environment settings are the same for all users that use the same virtual machine. As with normal desktop installations, you must still ensure that the environments on different virtual machines are the same.

We strongly recommend that you use standard Tekla Structures environments and customize them with company or project-specific settings on the network file server.

3. Install Citrix Receiver on each Tekla Structures client computer.

We recommend that you use the Citrix Receiver web user interface.

- a. In your web browser, open the Citrix Receiver web user interface.
Use the `https` address provided by your company's administrators.
- b. To install Citrix Receiver, follow the steps in the installation wizard.
In the installation wizard, do not create an account or sign in. Finish the installation, then return to the Citrix Receiver web user interface.

- c. After the installation, return to the Citrix Receiver web user interface and sign in with the credentials provided by your company's administrators.
- d. Select the virtual desktop. If the virtual desktop does not start automatically, run the downloaded Citrix (.ica) file.

3 Manage Tekla Structures licenses

There are two main types of licenses in Tekla Structures:

- Online licenses, which is the default option for new Tekla Structures licenses and how the Tekla Model Sharing feature is licensed.
- On-premises licenses that you activate locally on a license server you install on your own hardware. Users connect to your local server to reserve a license.

Working with online licenses

You activate online licenses for each user's Trimble Identity, after which the user is able to choose a license when they log in to Tekla Structures.

Administrator users can monitor the online license usage and **contract manager** users can manage your subscription renewals in the Tekla Online Admin Tool.

For online license instructions, see [Manage Trimble Identities and Tekla Online licenses](#).

Working with on-premises licenses

To get started with on-premises license administration:

1. Make sure you understand how licensing works, see [Tekla Structures on-premises licensing for administrators \(page 30\)](#).
2. Install the license server as explained in [Installing Tekla on-premises license server \(page 45\)](#).
3. Make sure the license server can connect to Trimble's activation server and clients can connect to the license server, see [Allowing Tekla on-premises license server to operate through Windows Firewall \(page 54\)](#).
4. Activate your licenses on the server as explained in [Activate on-premises licenses \(page 65\)](#).
5. Test that licensing works and connect the clients to the license server as explained in [Preconfigure license server settings for users \(page 69\)](#).

Additionally, you can ensure that the correct types of on-premises licenses are available to the users who most need them by defining access rights for using and borrowing licenses as explained in [Modify on-premises license access rights \(tekla.opt\) \(page 74\)](#). This can prevent situations where there are no licenses available for users that need them because someone else has reserved or borrowed a license that they do not really need.

When you renew on-premises licenses and when you need to make hardware changes on the license server, you must deactivate your licenses as explained in [Deactivate on-premises licenses \(page 70\)](#).

If your on-premises licenses have become untrusted or disabled, they cannot be used and you need to repair them. For information about how to do this, see [Repair an on-premises license \(page 80\)](#).

See also

[Troubleshoot Tekla licensing \(page 81\)](#)

3.1 Tekla Structures on-premises licensing for administrators

The information on this page is not valid for online subscriptions.

On-premises licenses are an alternative to the default Tekla Structures online subscription. Whether you use an on-premises license or an online subscription is determined when you purchase a license, so you cannot change between the two distribution methods yourself. You activate on-premises licenses on a license server that you install on your own computer hardware. Tekla Structures installations for one or more users connect to the license server to reserve a license.

On-premises licensing technology

With on-premises licensing, Tekla Structures uses FlexNet (FlexNet Publisher License Management) licensing system by Flexera Software. We provide our own Tekla-specific tools for managing the licenses on top of the common FlexNet platform, replacing some of the standard tools you may have encountered when using other software products that use FlexNet for licensing.

The license server software is compatible with several versions of Tekla Structures. To see which license server version to use with your current Tekla Structures version, see [Hardware recommendations for Tekla license server](#). The licenses are also compatible with older versions of Tekla Structures in addition to the highest allowed version stated in the license. The license is sent to you attached in an email as an entitlement certificate HTML file.

NOTE Keep backup copies of your license entitlements in a safe place.

Local licensing on your workstation

If there are few users in your organization and you do not need to share the same licenses between users, you will install a license server directly on the Tekla Structures workstation. When you activate a license on the local license server, Tekla Structures always uses that license and you can also start Tekla Structures offline without borrowing a license. If you want to use this type of setup, see Installation and licensing workflow.

For organizations with many users, it is not optimal to install and manage a license server on each workstation because of the extra work involved, lack of visibility and inability to flexibly share licenses between users. In this situation, it is better to set up a central license server in your internal network.

License server in your local area network (floating licenses)

This illustration shows how licensing works in a typical corporate setup where licenses are activated on a centrally-managed license server, and a mix of on-premises license and Tekla Structures subscriptions is used.

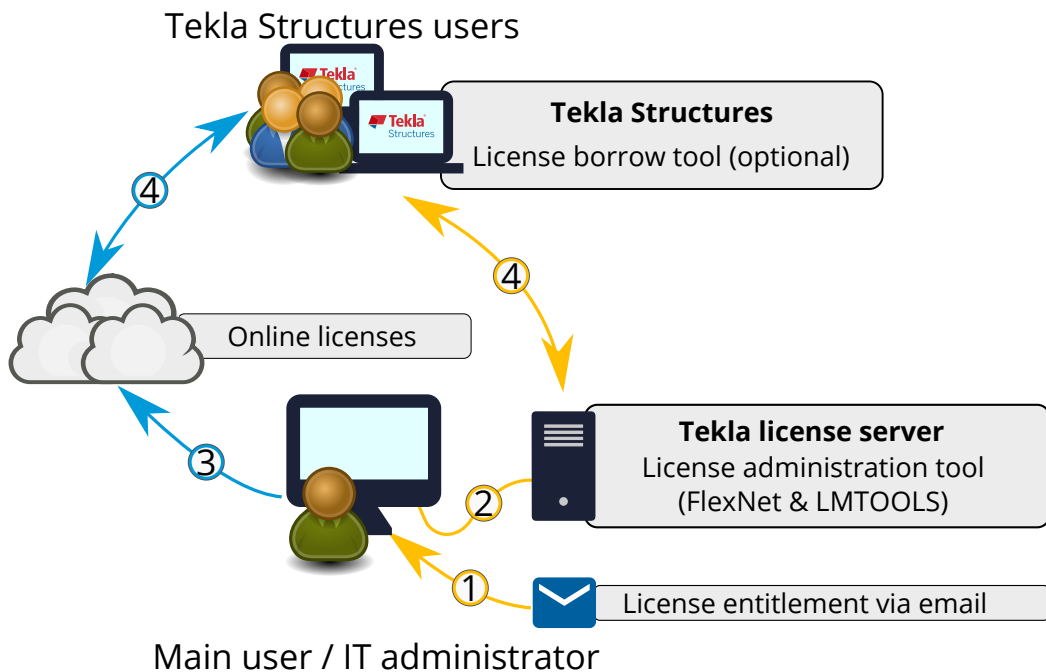

1. An administrator (main user or IT administrator) receives entitlement certificates for new and updated FlexNet licenses as email attachments.

2. The administrator activates and manages the FlexNet licenses in the Tekla License Administration Tool on the license server installed at your organization.

For successful activation, the system must be able to contact Trimble's online license activation service.

3. The administrator adds users to your organization and allows access to your purchased Tekla Structures subscriptions in the [Tekla Online Admin tool](#).

Exception: educational users must get their free Tekla Student subscription themselves at [the Tekla Campus site](#).

4. Tekla Structures installations on the end-users' workstations reserve a license on the license server or in the cloud when a user starts Tekla Structures or joins Tekla Model Sharing. When the user stops using Tekla Structures, the license reservation is revoked.

- You can optionally allow users to borrow licenses for a set period of time, which allows the user to start Tekla Structures without network access to the license server. To borrow a license, the user must have the license borrow tool installed on their workstation.
- Tekla Structures subscriptions cannot be borrowed. Users must have internet access to start Tekla Structures with a subscription. For more information about subscriptions, see [Manage Trimble Identities and Tekla Online licenses](#).

Tekla Structures holds licenses in trusted storage. This means that Tekla Structures does not support three-server redundancy, where licenses are held in license files. However, you may have any number of license servers, and use search paths for defining and finding them.

Using multiple license servers in one company

You may want to spread your license pool on several servers in your company. You may have offices in many cities, each office with its own license server, or you may simply want to divide the license pool to minimize disruption caused by server downtime.

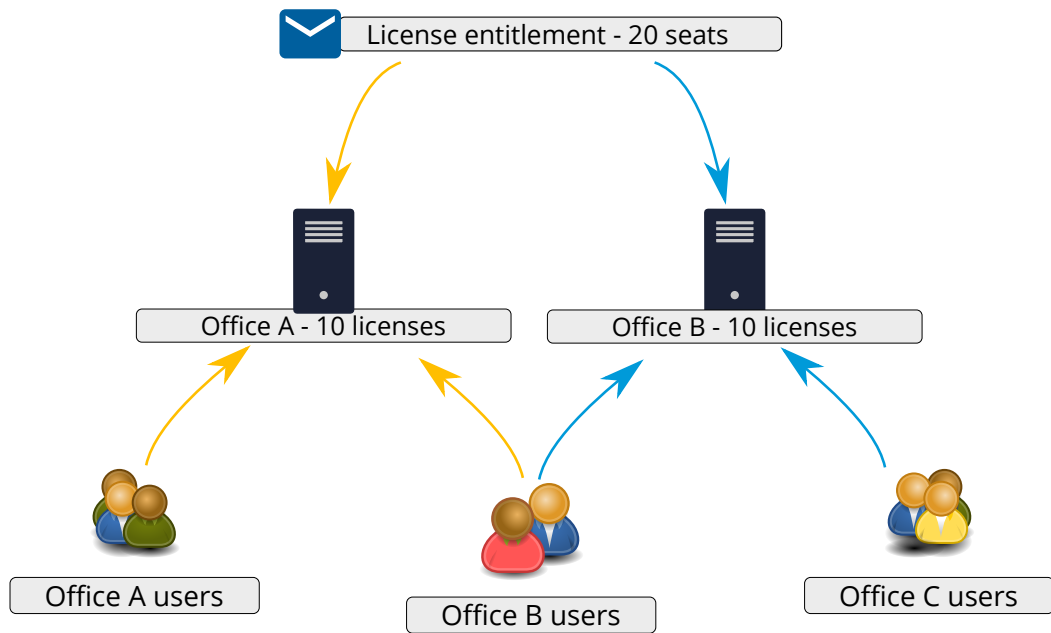

You do not have to activate all of the licenses on the same license server even if they are on the same entitlement certificate. For example, you can divide your total license entitlement on several servers simply by activating one half of your licenses on one server and the other half of the licenses on another server. Or, as another example, you can activate some of the licenses on a common server and the rest locally on each user's computer. You can easily change the location of the licenses by deactivating them on one license server and activating on another so you can adjust the number of licenses to changes in your user base over time.

In Tekla Structures, you can define two server addresses separated by a semicolon (;). This way, if there is a maintenance break on one of the servers, users can obtain the license from the other server.

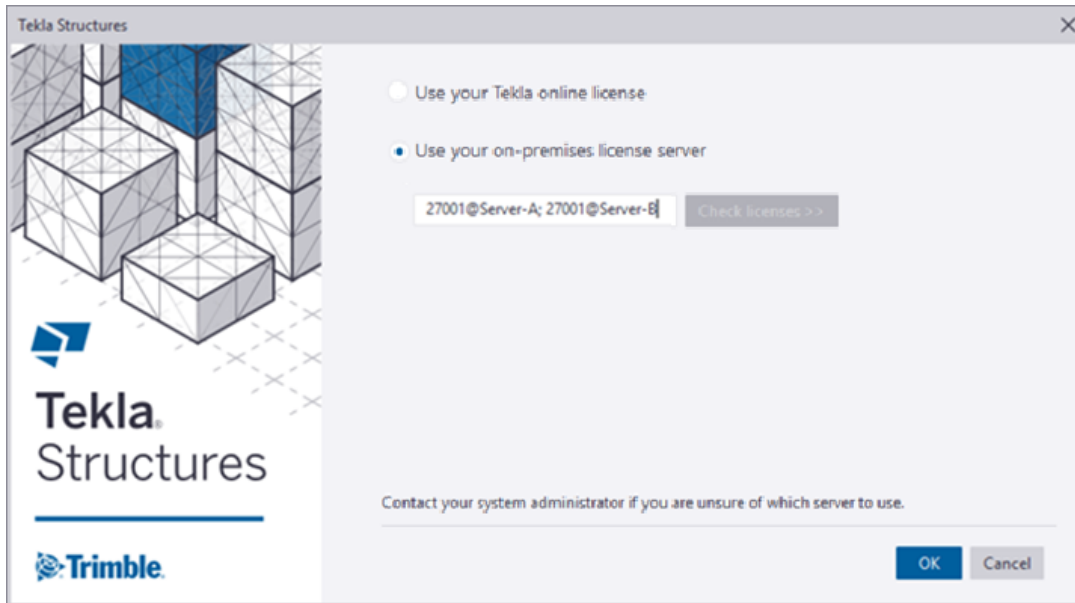

NOTE Defining several license servers may slow down the starting of Tekla Structures. Therefore, we do not recommend defining more than two servers.

License server hardware

The Tekla license server does not need high performance hardware. However, it is important to ensure that the network connection and server hardware are reliable, and to maintain the server system carefully.

NOTE Deactivate your licenses before you make changes to the hardware or perform a major operating system upgrade on the license server computer. Keep copies of your license entitlement certificate(s) in a safe place in case something goes wrong, so that you can easily and quickly activate the deactivated licenses on a different system. You can only activate the same licenses again if they have first been deactivated on the previous system. If the license server system becomes permanently inoperable with the licenses still activated, contact your local Tekla support for assistance.

See Tekla license server hardware recommendations for information about operating systems and virtual machine platforms.

Configuration features for on-premises licenses

You have fine-grained control over the license use:

- You can control license use based on the license type (enterprise/domestic) or Tekla Structures configuration.
- You can define minimum and maximum numbers of licenses users/user groups have available.

- You can allow or prevent license borrowing from named users/user groups.

The configurations can be done based on host addresses, individual user names or by user groups. See [Modify on-premises license access rights \(tekla.opt\) \(page 74\)](#) for more information.

Checklists for on-premises licensing implementation

There are several prerequisites the administrator needs to take into account before starting with FlexNet licensing. Take a look at the following listings:

- [Checklist of Trimble deliverables needed in on-premises licensing \(page 35\)](#)
- [Checklist of IT resources needed in on-premises licensing \(page 36\)](#)
- [Checklist for the on-premises license server administrator \(page 37\)](#)
- [Rights needed for administrator tasks in on-premises licensing \(page 38\)](#)

Additional information sources

In addition to Tekla Structures specific documentation, you can find useful information about the FlexNet system in the documents provided with the installation and in [Tekla Downloads](#). The following **FlexNet License Administration Guides** by Flexera Software are generic guides that contain, for example, instructions on how to create user groups and manage access rights:

- C:\Tekla\License\Server\fnp_LicAdmin.pdf
- C:\Tekla\License\Server\LicenseAdministration.pdf

See also

[Distributing and managing on-premises licenses \(page 38\)](#)

[Examples of different on-premises licensing setups \(page 40\)](#)

[Installing Tekla on-premises license server \(page 45\)](#)

Checklist of Trimble deliverables needed in on-premises licensing

The information on this page is not valid for online subscriptions.

To get started with the Tekla Structures on-premises FlexNet licensing, the administrator needs to have the following items provided by Trimble:

- **Entitlement certificate**

Trimble has sent the license entitlement certificate in an e-mail to the person in your organization who has made the license purchase, or to someone named as the contact person. The entitlement certificate lists all

the Tekla Structures licenses you are entitled to use and includes the activation IDs for entitled licenses.

For entitlement requests, contact your local Tekla representative.

- **Tekla license server installation package**

The Tekla license server installation package is available on [Tekla Downloads](#) product download service. The installation package contains the license server files and Tekla License Administration Tool.

- **License Administration Guide**

This guide by Flexera Software is a general guide that contains, for example, instructions on how to create user groups and manage access rights. This guide is provided in the license server installation package and is installed in the folder where you install the license server in the .pdf format.

Checklist of IT resources needed in on-premises licensing

The information on this page is not valid for online subscriptions.

In Tekla Structures on-premises licensing, you need to install the licensing tools on your own hardware, taking into account the following IT resource related requirements:

- **Supported operating system**

The FlexNet licensing system for Tekla Structures runs in Windows operating system. The support for virtual servers is limited. For more information, see Tekla Structures Hardware recommendations in Tekla User Assistance.

- **Windows user account with administrator rights**

Your Windows login user name should not contain any special characters.

You need to have administrator rights to install and manage the license server. For more information, see [Rights needed for administrator tasks in on-premises licensing \(page 38\)](#).

- **TCP/IP port 27007 for license server**

Tekla licensing service (lmgrd) is automatically run in the TCP/IP port 27007. This port should be dedicated for Tekla licensing service only. If required, you can manually set a different TCP/IP port for the licensing service, see [Modify the license file tekla.lic manually \(page 51\)](#).

- **Local area network**

The license server and the client computers need to be in the same local area network. The clients need to be able to contact the license server. If there is no local area network in your company, we recommend that you

install the license server on each computer that has Tekla Structures and activate one license on each computer.

- **Internal firewall and direct communication**

The internal firewall of your company (for example, Windows Firewall) must allow the communication between the server computer and the computers with Tekla Structures. You must allow the applications `tekla.exe` and `lmgrd.exe` to operate through the firewall. For more information, see [Allowing Tekla on-premises license server to operate through Windows Firewall \(page 54\)](#).

Direct communication from the server computer to the Internet needs to be allowed when the license server at your company contacts the activation server at Trimble Solutions. The activation communication uses SOAP over HTTPS on the TCP/IP port 443.

Your firewall should not block any incoming or outgoing information during the activation. To allow the activation communication, use the activation server address in your firewall settings:

<https://activate.tekla.com:443/flexnet/services/ActivationService?wsdl>

If direct communication from the server computer to the Internet is not allowed, contact your local Tekla Structures support for manual activation.

- **System backup settings**

If you have an automatic backup and restore system in your company, configure your system so that it does not overwrite your actual Trusted Storage with the backup copy. Trusted Storage is the place where the licensing information is stored on the server computer, and it is located in `C:\ProgramData\FLEXnet` depending on the operating system.

Checklist for the on-premises license server administrator

The information on this page is not valid for online subscriptions.

Your company or organization should assign an administrator for the Tekla Structures on-premises license server. The license server administrator's primary responsibilities are:

- Install the Tekla license server: [Installing Tekla on-premises license server \(page 45\)](#)
- If automatic installation is not possible, manually install and configure Tekla license server: [Install Tekla license server - manual installation \(page 48\)](#), [Configure Tekla license server manually \(page 52\)](#), [Modify the license file tekla.lic manually \(page 51\)](#)
- Save the entitlement certificate on the license server computer and activate licenses on the server to make the licenses available for Tekla Structures

users, or for yourself, if the license server is installed on your own computer: [Activate on-premises licenses \(page 65\)](#)

- Inform users of the license server name and port number so that they can connect Tekla Structures to the server: [Preconfigure license server settings for users \(page 69\)](#)
- If necessary, modify the firewall settings to allow licensing traffic: [Allowing Tekla on-premises license server to operate through Windows Firewall \(page 54\)](#)
- If necessary, modify license access rights in the `tekla.opt` options file: [Modify on-premises license access rights \(tekla.opt\) \(page 74\)](#)
- Export a customized product ID files for license borrowing and deliver them to offline users: [Provide offline users with a customized product ID file \(page 106\)](#)
- Inform users of the license policy of the company and monitor license use.

Rights needed for administrator tasks in on-premises licensing

The information on this page is not valid for online subscriptions.

You need to have Windows administrator rights to install and manage the Tekla Structures on-premises license server. Some applications also need to be run as administrator separately. This depends on the Windows version you are using.

- In **Windows 7, Windows 8/8.1** and **Windows 10**, you need to log in as administrator. In some cases, you need to run applications as administrator. To do this, go to the folder containing the application, right-click the application and select **Run as administrator** from the pop-up menu.
- In **Windows Server** you need to log in as administrator. In some cases, you need to run applications with *unrestricted rights*. To do this, right-click the application, select **Run as**, and clear the **Run this program with restricted access** check box.

Distributing and managing on-premises licenses

The information on this page is not valid for online subscriptions.

The Tekla Structures FlexNet licensing system offers several options for distributing licenses to users. The way you distribute the licenses depends on the size of the company or organization, and the amount of Tekla Structures users.

There are two basic ways of distributing licenses to users:

- The licenses are available for multiple users on a common license server.
- The licenses are activated on each user's own computer.

You can also use a combination of license distribution methods. For example, you can activate one license on a separate computer and activate the rest of your licenses on a common license server.

You can also use online licenses together with on-premises licenses. Users can switch between the two licensing methods when they start Tekla Structures. For example, users can use an on-premises license at the office, but switch to an online license when they are outside the office when they are mostly within reach of the internet. Using an online license eliminates the need to borrow licenses or connect to the office through VPN just to reserve a license.

The following table shows what is typical for managing the licenses that are activated separately on each computer, and for licenses that are activated on a common license server.

Licenses are activated on user's own computer	Licenses are activated on a common license server
<p>No need for an assigned license server administrator.</p> <p>Each user manages the license server that is installed on the user's own computer.</p>	<p>Centralized maintaining and administration of licenses is needed.</p> <p>A license server administrator maintains the license server and manages the license use.</p> <p>Typically, there are a few Tekla Structures main users in a company. The main users are good candidates for license server administrators, because they are already familiar with Tekla Structures. For more information on the responsibilities of the license server administrator, see Checklist for the on-premises license server administrator (page 37)</p>
<p>No need to manage license access rights.</p> <p>Each user activates only the licenses that are needed.</p>	<p>By default, all license configurations activated on the server are available for all Tekla Structures users. However, centralized access rights management is possible.</p> <p>The license server administrator can give different users access to different configurations. The license server administrator needs to modify the <code>tekla.opt</code> options file to manage the license access rights. For more information on managing license</p>

Licenses are activated on user's own computer	Licenses are activated on a common license server
	access rights, see Modify on-premises license access rights (tekla.opt) (page 74).
<p>Tekla Structures can be used out of office.</p> <p>If the user's license is activated on a computer, license borrowing or a VPN connection is not needed.</p>	<p>Tekla Structures can be used out of office.</p> <p>A user needs to borrow a license from the common license server or use a VPN connection to the license server to use Tekla Structures out of office.</p>
<p>Licenses are used only by one person. Users have access only to the licenses that are activated on their own computer. If a user needs a license that is activated on another computer, the user needs to use the other computer. Another option is to deactivate licenses on one computer and activate them on another, which requires effort.</p>	<p>Licenses are checked out frequently by several users.</p> <p>When the licenses are activated on a common server, they are available for multiple users. The licenses are checked out from the license server only when they are needed. When a user does not need a license, the user closes Tekla Structures and the license becomes available for another user. Switching from using one license to another is simple.</p>
	<p>Rules of license usage</p> <p>Tekla Structures users should accept common rules or an internal company policy. The rules should contain regulations of managing the licenses, for example, who is allowed to borrow licenses. Usage of common rules minimizes the amount of conflicts in license management.</p>

Examples of different on-premises licensing setups

The information on this page is not valid for online subscriptions.

The purpose of the following examples is to provide guidelines for Tekla Structures on-premises license management in companies or organizations of different sizes.

Example 1: One Tekla Structures user, all licenses activated on one computer

Only one user in the company uses Tekla Structures. The user installs Tekla Structures and the license server on the same computer.

- Installing the license server is straightforward, and the default license server settings can be used. The user does not need to modify the license server settings, because the user runs the license server and Tekla Structures on the same computer.
- Because the user installs the license server on a computer, the user does not need to borrow a license or use a VPN connection to use Tekla Structures out of office.

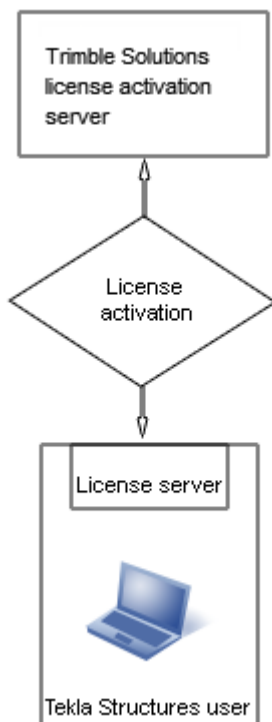

Example 2: Three Tekla Structures users, necessary licenses activated separately on each computer

There are three Tekla Structures users in a company. Because the users use different Tekla Structures configurations, each user installs a license server separately on the user's own computer and activates only the needed licenses.

- A license server administrator is not needed, the users maintain their license servers.
- Because the users install the license servers on their computers, they do not need to borrow a license or use a VPN connection to use Tekla Structures out of office.

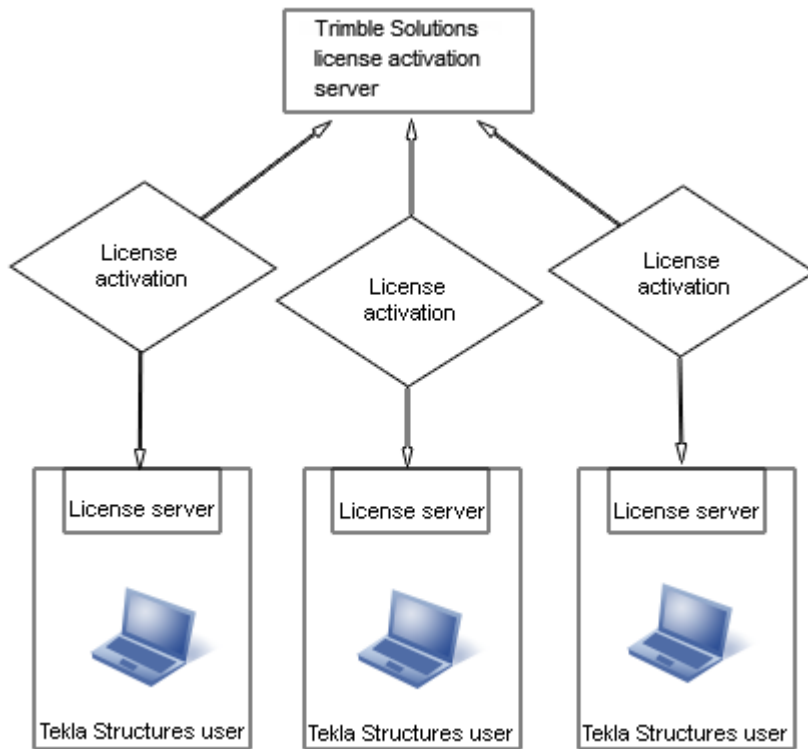

Example 3: Ten Tekla Structures users, necessary licenses activated on a common license server and one user's computer

There are ten Tekla Structures users in a company

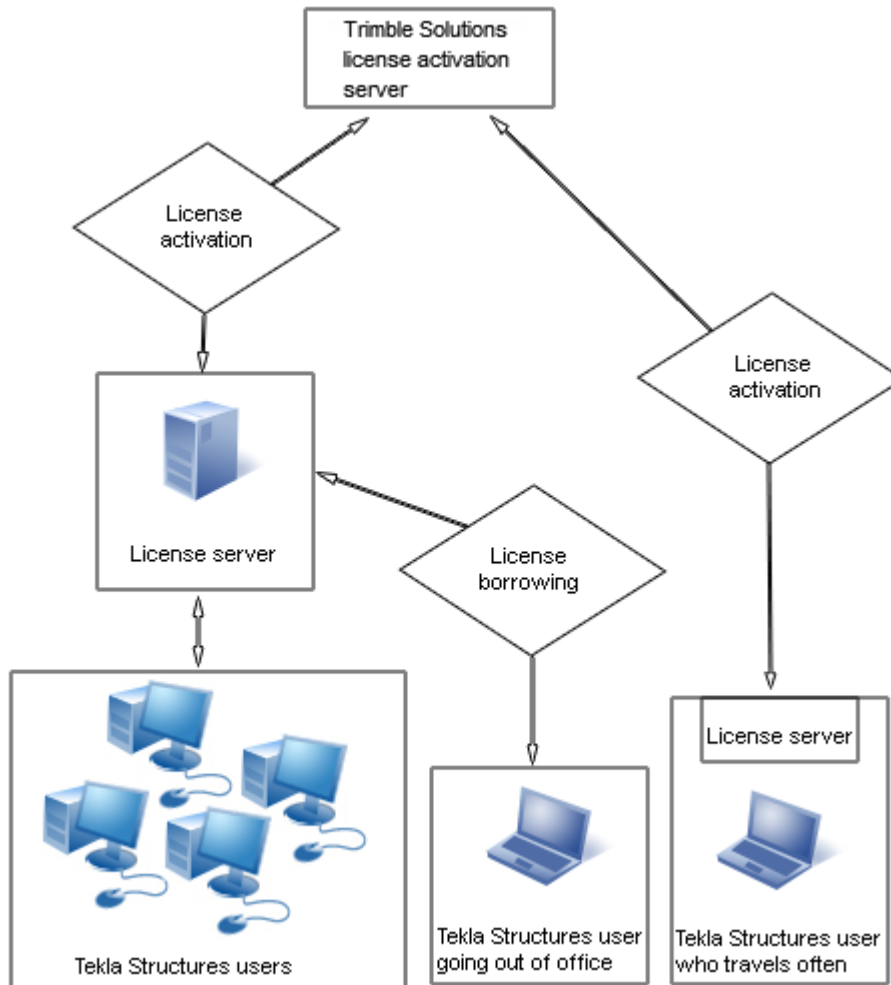

y.

Because the users use different configurations, the company uses a common license server.

- The company has an internal policy for license use containing regulations for managing the licenses.
- One of the main users is assigned as the license server administrator. The administrator installs the license server and informs the other users of the hostname and port number of the server. The license server administrator also performs other server maintenance duties.
- One of the users travels a lot and needs Tekla Structures on the journeys. A license server is installed separately on the user's computer, so the user does not need to borrow a license or use a VPN connection for offline use of Tekla Structures.
- Other users borrow licenses from the license server when they need to use Tekla Structures offline.

Example 4: Fifty Tekla Structures users in two offices, necessary licenses activated on two separate servers

There are fifty Tekla Structures users in two separate offices. Both offices have their own license servers.

- Both offices have assigned license server administrators. The license server administrators install the license servers and perform license server maintenance duties.
- The company has an internal policy for using licenses. The policy contains, for example, the rules that define who is allowed to borrow licenses.
- Because the amount of Tekla Structures users is large, the license server administrators create `tekla.opt` options files for controlling the access rights for different licenses.
- Only a couple of users need to use Tekla Structures offline. The license server administrators modify the option files to enable the license borrowing only for those users who need to borrow licenses.
- If one server fails, the users can connect to the license server at the other office. If there are licenses available on the license server, the users can use the licenses.

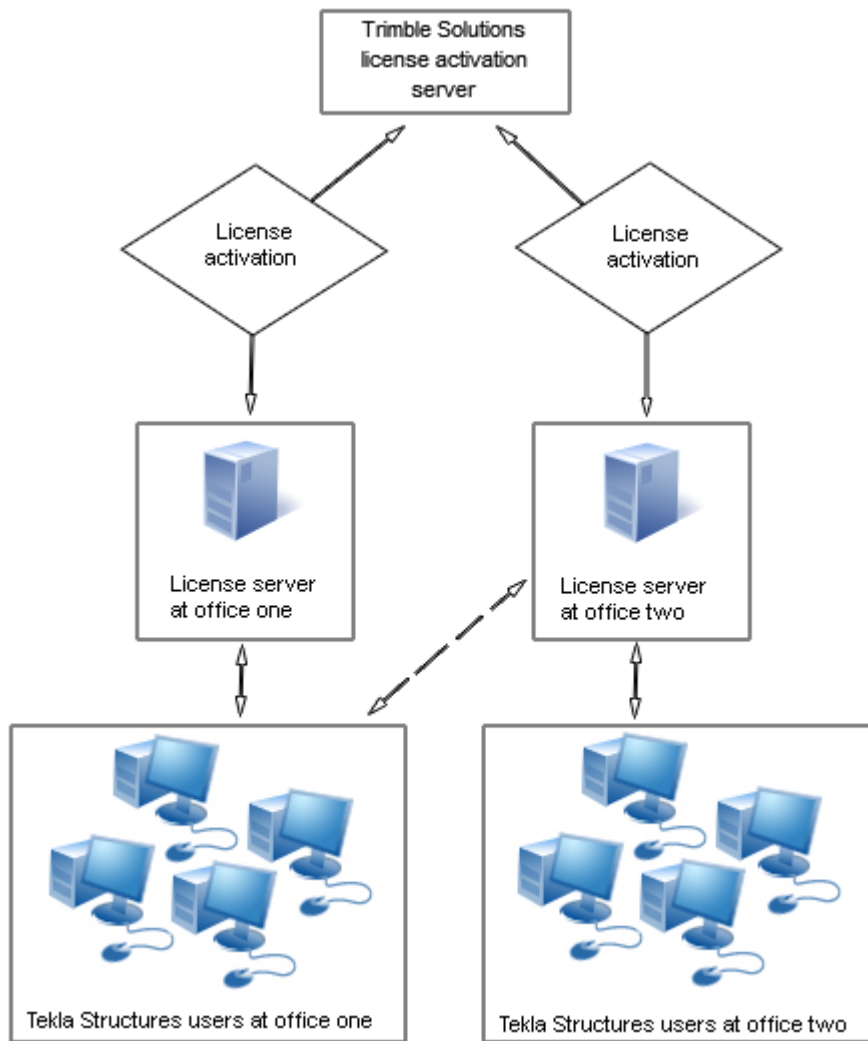

3.2 Installing Tekla on-premises license server

The Tekla on-premises license server installation package contains license server files, applications for license management and guides. To install the license server software, download the license server installation package with the latest updates from [Tekla Downloads](#) product download service.

You have two choices in installation:

- **Automatic default installation:** Select automatic installation for normal setup. Automatic installation is recommended.

For detailed installation instructions, see [Install Tekla license server - automatic installation \(page 47\)](#).

- **Manual installation:** Use manual installation if you need to separately install the license server, modify the license file, configure the license service, and start the server software. This is needed if you want to use another TCP/IP port than the one used in the automatic installation, for example. Use manual installation only if you are an advanced user of FlexNet or FlexIm licensing.

For detailed installation instructions, see [Install Tekla license server - manual installation \(page 48\)](#).

Before installing Tekla license server

- Install the license server using administrator's rights.
- Turn off the internal firewall and pause the antispyware/antivirus protection.
- Ensure that you have access to the Internet. The Internet connection is needed during the license activation process. An unreliable connection speed may cause errors.
- If you are using other FlexNet licensing services, you need to stop them before you install the Tekla license server. When you have completed installing the Tekla license server, you can restart the other licensing services.

See also

[Problems in Tekla license server installation and connecting to the license server \(page 82\)](#)

[Activate on-premises licenses \(page 65\)](#)

[Allowing Tekla on-premises license server to operate through Windows Firewall \(page 54\)](#)

Which on-premises license server version to use

Check the table below to see which on-premises license server version to use with your current Tekla Structures version. Also check if you need to upgrade to a new service pack or progress release.

For information about updating the on-premises license server, see [Update the Tekla on-premises license server](#).

Tekla Structures version	License Server 2016 SP1	License Server 2017 or later
2018 or later		✓
2017i - all versions		✓
2017 - all versions	✓	✓

Tekla Structures version	License Server 2016 SP1	License Server 2017 or later
2016i - all versions	✓	✓
2016 SP5/PR5 or later	✓	✓
2016 up to SP4/PR4	✓	Upgrade to 2016 SP5/PR5 or later
21.1 SR7 or later	✓	✓
21.1 up to SR6	✓	Upgrade to 21.1 SR7 or later
21.1 all PV versions	✓	✓
21.0 or earlier	✓	✓

For instructions on how to install the license server, see [Install Tekla on-premises license server](#).

Install Tekla license server - automatic installation

Before you start license server installation, stop FlexNet licensing services and other licensing services.

For more information about which license server version to use, see [Hardware recommendations for Tekla license server](#).

To install the default setup of the Tekla license server to a computer that does not have a previous version of Tekla license server installed:

1. To download the license server installation package with the latest updates, go to [Tekla Downloads](#), select the Tekla Structures version, and click **All downloads**. On the next page, select **License server** as the **File type** and click **Apply filter**. Then select the **License server**.
2. Select the installation language.
3. Select **Automatic** as the licensing service installation type to install the default setup.
4. Select the folder where you want to install the license server and complete the installation.

Tekla license server is installed.

In automatic license server installation, the license server address is automatically set to `27007@your_hostname`, where `27007` is the port and `your_hostname` is the computer name/hostname. `27007@your_hostname` is used as the license server address in every Tekla Structures installation.

When you have installed the license server, you need to do the following:

- Save the entitlement certificate and activate the licenses. For more information, see [Activate on-premises licenses \(page 65\)](#).
- Connect Tekla Structures to the license server. For more information, see [Preconfigure license server settings for users \(page 69\)](#).
- You can also change the language of the user interface in Tekla License Administration Tool by opening the tool and clicking **Language**.

See also

[Install Tekla license server - manual installation \(page 48\)](#)

[Problems in Tekla license server installation and connecting to the license server \(page 82\)](#)

[Problems in Tekla licensing: Error codes and their descriptions \(page 97\)](#)

Install Tekla license server - manual installation

Use manual installation if you want to separately install the license server, modify the license file, configure the license server, and start the license server software. In manual installation of Tekla license server, you also install two files: `installanchorservice.exe` and `uninstallanchorservice.exe`. You need these files when you manually install or uninstall FlexNet Licensing Service.

For example, you need to install the license server manually if the default TCP/IP port 27007 is already in use by other services or applications, and you need to define another port in the license file `tekla.lic`.

Before you start license server installation, stop other FlexNet licensing services.

To install the license server manually:

1. To download the license server installation package with the latest updates, go to [Tekla Downloads](#), select the Tekla Structures version, and click **All downloads**. On the next page, select **License server** as the **File type** and click **Apply filter**. Then select the **License server**.
2. Select the installation language.
3. Select **Manual** as the licensing server installation type and complete the installation.
4. Go to the **Start** menu or **Start screen** (depending on your Windows operating system) and open **Command Prompt** as administrator.
5. At the command prompt, enter the following commands:
 - a. `cd /d %SYSTEMDRIVE%\Tekla\License\Server`
 - b. `installanchorservice.exe`

The licensing server is installed.

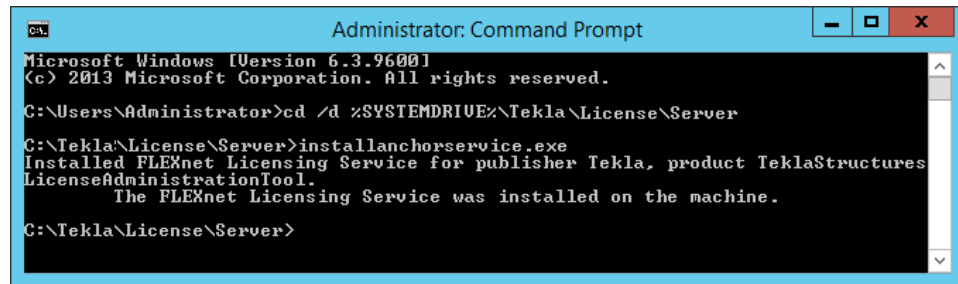

```
Administrator: Command Prompt
Microsoft Windows [Version 6.3.9600]
(c) 2013 Microsoft Corporation. All rights reserved.
C:\Users\Administrator>cd /d %SYSTEMDRIVE%\Tekla\License\Server
C:\Tekla\License\Server>installanchorservice.exe
Installed FLEXnet Licensing Service for publisher Tekla, product TeklaStructures
LicenseAdministrationTool.
The FLEXnet Licensing Service was installed on the machine.
C:\Tekla\License\Server>
```

6. Modify the license file to include the hostname or IP address of the server, and the correct TCP/IP port:
 - a. Open the `..\Tekla\License\Server` folder on the server computer.
 - b. Open the `tekla.lic` (license file) file with a text editor.
 - c. Replace text `localhost` on the line `SERVER localhost ANY` with the hostname (computer name) or IP address of the license server.
 - d. Enter the TCP/IP port number after text `SERVER server_hostname ANY`.
 - e. Save the changes and close the text editor.
7. Go to **Tekla Licensing** --> **LMTTOOLS** through the **Start** menu or **Start screen**, depending on your Windows operating system.
8. On the **Service/License File** tab, click **Configuration using Services**.
9. On the **Config Services** tab to configure the licensing service:
 - a. In the **Service Name** box, enter the name of the service exactly as follows: `Tekla Licensing Service`.
 - b. Click the **Browse** buttons to locate the `lmgrd.exe` (license server manager), `tekla.lic` and `tekla_debug.log` files.

By default, `lmgrd.exe`, `tekla.lic` and `tekla_debug.log` are located in the `C:\Tekla\License\Server` folder.

Note that if you set **Path to the debug log file** outside the `"C:\ProgramData\..."` folder, you get an error message: "Windows preferred path <SystemDrive>\ProgramData to store service data is not set." This error message can be ignored.
 - c. Select the **Use Services** check box to run the licensing service as a Windows service.
 - d. Select the **Start Server at Power Up** check box to start the licensing service automatically after Windows startup.
 - e. Click **Save Service** to save the settings.

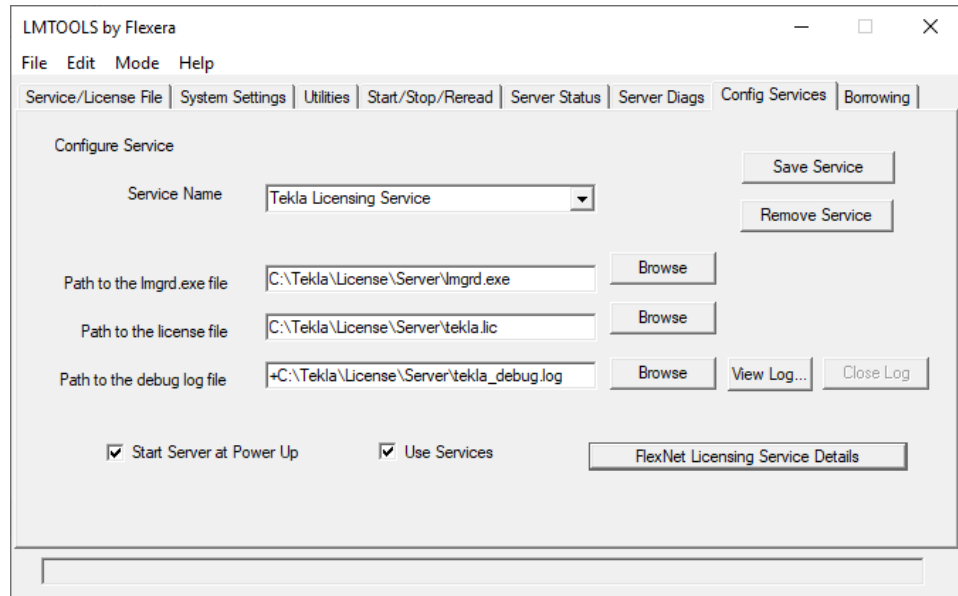

- Go to the **Start/Stop/Reread** tab and click **Start Server** to start the license server.

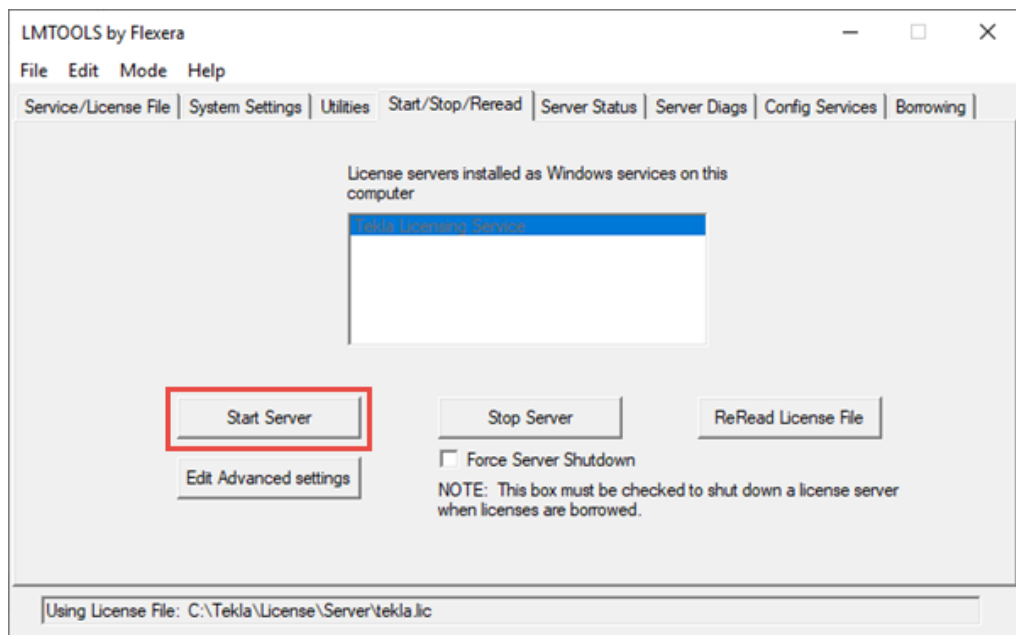

- Go to the **Server Status** tab and click **Perform Status Enquiry**.
 In the status list, the line `License server status` shows the TCP/IP port and hostname of the license server.
 Now you can activate the licenses and connect Tekla Structures to the license server.
 You can also change the language of the user interface in Tekla License Administration Tool by opening the tool and clicking **Language**.

See also

[Modify the license file tekla.lic manually \(page 51\)](#)

[Activate on-premises licenses \(page 65\)](#)

[Configure Tekla license server manually \(page 52\)](#)

[Problems using LMTOOLS in Tekla licensing \(page 92\)](#)

[Problems in Tekla licensing: Error codes and their descriptions \(page 97\)](#)

Modify the license file tekla.lic manually

If you selected the **Automatic** installation option, the license server is set to your hostname: `27007@server_hostname (port@hostname)`.

The licensing system automatically searches for an available TCP/IP port and uses the first available port detected. The **Automatic** installation sets the port to 27007.

You need to modify the `tekla.lic` license file if you:

- Select the **Manual** license server installation option
- Want to change the TCP/IP port of the licensing server
- Want to use the IP address of your computer instead of the hostname

To modify the license file `tekla.lic` manually:

1. Go to the `..\Tekla\License\Server` folder on the server computer.
2. Open the `tekla.lic` file in a text editor.
3. Make the necessary changes:
 - To use hostname or IP address: Replace text on the first line between words `SERVER` and `ANY` with the hostname or IP address of your license server.

Do not delete texts `SERVER` and `ANY` when you enter the hostname or IP address of the license server.

The following formats are valid:

Hostname: `server_hostname`

Domain name: `server_hostname.mycompany.com`

IP address: `10.0.0.12`

```
tekla.lic - Notepad
File Edit Format View Help
SERVER server_hostname ANY
VENDOR tekla
USE_SERVER
FEATURE TeklaServer tekla 1 31-dec-2025 1 SIGN="10E5 B774 BDF3 B93A \
80C9 20DA 9E84 E81E E8DB D37C F64F FE73 ECA0 2FED 0EFD 162F \
2851 AAF4 6314 76C0 AB53 105F E481 D92A EDBC 735E C5F2 9CD0 \
2CC4 2C09"
```

You can check the hostname of the license server in **LMTOOLS** on the **System Settings** tab. Go to **Tekla Licensing** --> **LMTOOLS** through the **Start** menu or **Start screen**, depending on your Windows operating system.

- To set the TCP/IP port manually: Enter the TCP/IP port number **after** text `SERVER server_hostname ANY`.

The port number can be any free port in the range of 0 - 64000.

```
tekla.lic - Notepad
File Edit Format View Help
SERVER server_hostname ANY 27007
VENDOR tekla
USE_SERVER
FEATURE TeklaServer tekla 1 31-dec-2025 1 SIGN="10E5 B774 BDF3 B93A \
80C9 20DA 9E84 E81E E8DB D37C F64F FE73 ECA0 2FED 0EFD 162F \
2851 AAF4 6314 76C0 AB53 105F E481 D92A EDBC 735E C5F2 9CD0 \
2CC4 2C09"
```

4. Save the changes and close the text editor.
5. Restart the Tekla Licensing Service in **LMTOOLS** or Windows Services for the changes to take effect.

See also

[Install Tekla license server - manual installation \(page 48\)](#)

Configure Tekla license server manually

If you encounter problems during the Tekla license server installation, the license server may not start automatically. If this happens, you need to configure the license server manually using **LMTOOLS**.

To configure the Tekla license server manually:

1. Go to **Tekla Licensing** --> **LMTOOLS** through the **Start** menu or **Start screen**, depending on your Windows operating system. Start **LMTOOLS** with administrators rights.
2. Go to the **Service/License File** tab and select **Configuration using Services**.

3. Go to the **Config Services** tab and do the following:

Service Name: Select the licensing service. When working with Tekla license server, always select Tekla Licensing Service.

Path to the lmgrd.exe: Click **Browse** and locate `lmgrd.exe`. This file is by default located in the `C:\Tekla\License\Server` folder.

Path to the license exe: Click **Browse** and locate `tekla.lic`. This file is by default located in the `C:\Tekla\License\Server` folder.

Path to the debug log file: Click **Browse** and locate `tekla_debug.log`.

This file is by default located in the `C:\Tekla\License\Server` folder.

To append the logging entries in the debug log file, start the debug log file name path with the plus sign (+), like by default for `tekla_debug.log`. If the plus sign is missing, the log file will be rewritten each time the service is started.

Note that if you set **Path to the debug log file** outside the "`C:\ProgramData\...`" folder, you get an error message: "Windows preferred path <SystemDrive>\ProgramData to store service data is not set." This error message can be ignored.

Use Services: Select the check box to run the licensing service as a Windows service.

Start Server at Power Up: Select the check box to start the licensing service automatically after Windows startup.

4. Click the **Save Service** button to save the settings.
5. Go to the **Utilities** tab and do the following:

Vendor Name: Enter `tekla` (all letters lowercase).

Path: Enter the name of the license server.

- If you run the license server and Tekla Structures on the same computer, enter `@localhost`. You can also enter the TCP/IP port, for example, `27007@localhost`.

- If you run the license server and Tekla Structures on separate computers, enter the hostname of the license server, for example, @server_hostname.
 - You can also enter the TCP/IP port of the license server, for example, 27007@server_hostname. You must define the port if you use another port than the default port.
 - You can also enter several license servers. Separate the server names with a semicolon. For example, 27007@server_hostname;27007@localhost.
6. Click the **Override Path** button to replace the existing license servers displayed in the status list on the **Server Status** tab.
 7. Go to the **Start/Stop/Reread** tab and start the license server by clicking **Start Server**.
The status bar should display a message telling that server start was successful.
 8. Go to the **Server Status** tab and enquire the license server status by clicking **Perform Status Enquiry**.

The status list displays the TCP/IP port and hostname of the license server. The list should indicate that license server is up and vendor daemon `tekla` is up. The list also displays all the activated licenses on the server.



See also

[Installing Tekla on-premises license server \(page 45\)](#)

[Problems in Tekla licensing: Error codes and their descriptions \(page 97\)](#)

3.3 Allowing Tekla on-premises license server to operate through Windows Firewall

When you set up Tekla on-premises license server in your network, you may also need to configure the firewall and antivirus settings:

- You need to allow the applications `tekla.exe` and `lmgrd.exe` to operate through the firewall on the license servers and on the client computers.

- The internal firewall at your company must allow the communication between the license server computer and the computers with Tekla Structures.
- If your Internet connection is restricted, change your firewall settings to allow communications via TCP port 443 (the default HTTPS) with outbound for traffic to `https://identity.trimble.com` and `https://activate.tekla.com`.
- In addition to allowing the exceptions in your actual firewall, you may need to configure exceptions for Windows Firewall. Windows Firewall may be set on without you being aware of it, because some Windows updates may automatically turn on the Windows Firewall.

For instructions on how to modify the firewall settings so that the Windows Firewall on the license server allows licensing traffic, see:

- [Allow exceptions in firewall for lmgrd.exe and tekla.exe \(page 55\)](#)
- [Allow traffic in fixed TCP/IP ports \(page 56\)](#)

In addition to Windows Firewall, the information given also applies to firewalls from other vendors.

Allow exceptions in firewall for lmgrd.exe and tekla.exe

You need to allow the applications `tekla.exe` and `lmgrd.exe` to operate through the firewall on the license server computer to enable licensing traffic.

To allow exceptions for `lmgrd.exe` and `tekla.exe` on the license server computer:

1. Press the **Windows logo key + R** on your keyboard to show the **Run** dialog box, then type `firewall.cpl` and press **Enter**.
2. In the left pane, click **Allow a program or feature through Windows Firewall** or **Allow an app or feature through Windows Firewall** (depending on the operating system).
3. In **Allowed programs** or **Allowed apps** (depending on the operating system), click **Change settings**.

Administrator permission is required. If you're prompted for an administrator password or confirmation, enter the password or confirm.

4. Click **Allow another program** or **Allow another app** (depending on the operating system).
5. Click **Browse** to browse for the `\Server` folder on the computer, select `lmgrd.exe` and click **Open**.

By default, the path is `... \TeklaStructures \License \Server`.

6. Click **Add** to add `lmgrd.exe` to the **Allowed programs** or **Allowed apps** and features list (depending on the operating system).
7. Select both **Home/Work (Private)** or **Private** (depending on the operating system) and **Public** check boxes next to `lmgrd.exe`.
8. Allow the exceptions also for `tekla.exe` by repeating the steps 4 – 7.
9. Click **OK** to confirm the changes.

See also

[Allowing Tekla on-premises license server to operate through Windows Firewall \(page 54\)](#)

Allow traffic in fixed TCP/IP ports

You need to modify the firewall settings to allow traffic through fixed TCP/IP port.

To allow traffic in fixed TCP/IP ports in Windows on the license server computer:

1. Ensure that no other software or service is using the ports that you are about to set fixed.

Use the command line command `netstat -anp TCP` to find out which ports are in use.

The numbers in the **Local Address** column after the colon (:) are the port numbers that are in use.

```

Administrator: Command Prompt
C:\Users\Administrator>netstat -anp TCP
Active Connections
Proto Local Address           Foreign Address         State
TCP   0.0.0.0:135              0.0.0.0:0              LISTENING
TCP   0.0.0.0:445              0.0.0.0:0              LISTENING
TCP   0.0.0.0:5985             0.0.0.0:0              LISTENING
TCP   0.0.0.0:27007            0.0.0.0:0              LISTENING
TCP   0.0.0.0:47001            0.0.0.0:0              LISTENING
TCP   0.0.0.0:49152            0.0.0.0:0              LISTENING
TCP   0.0.0.0:49153            0.0.0.0:0              LISTENING
TCP   0.0.0.0:49154            0.0.0.0:0              LISTENING
TCP   0.0.0.0:49155            0.0.0.0:0              LISTENING
TCP   0.0.0.0:49156            0.0.0.0:0              LISTENING
TCP   0.0.0.0:49159            0.0.0.0:0              LISTENING
TCP   0.0.0.0:49175            0.0.0.0:0              LISTENING
TCP   192.168.24.142:139      0.0.0.0:0              LISTENING
C:\Users\Administrator>

```

2. Browse for `tekla.lic`, and open it using a text editor.
By default, the path is `..\Tekla\License\Server`.
3. To set a fixed port for `lmgrd.exe`, enter the TCP/IP port number at the end of the `SERVER` row.

The **Automatic** installation option sets the port to 27007.

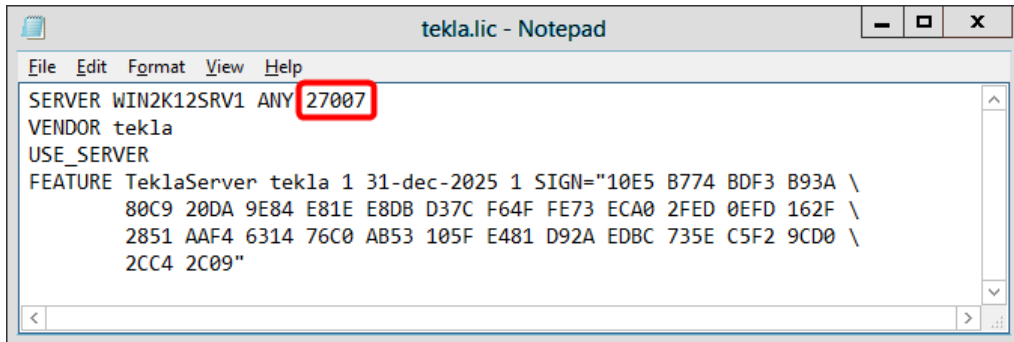

```
tekla.lic - Notepad
File Edit Format View Help
SERVER WIN2K12SRV1 ANY 27007
VENDOR tekla
USE_SERVER
FEATURE TeklaServer tekla 1 31-dec-2025 1 SIGN="10E5 B774 BDF3 B93A \
80C9 20DA 9E84 E81E E8DB D37C F64F FE73 ECA0 2FED 0EFD 162F \
2851 AAF4 6314 76C0 AB53 105F E481 D92A EDBC 735E C5F2 9CD0 \
2CC4 2C09"
```

4. Enter the text `port=free_port` at the end of the `VENDOR` row, for example, `port=1234`.

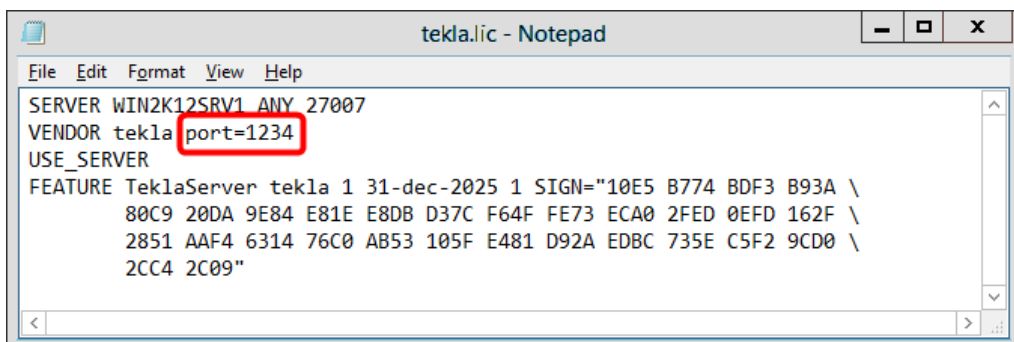

```
tekla.lic - Notepad
File Edit Format View Help
SERVER WIN2K12SRV1 ANY 27007
VENDOR tekla port=1234
USE_SERVER
FEATURE TeklaServer tekla 1 31-dec-2025 1 SIGN="10E5 B774 BDF3 B93A \
80C9 20DA 9E84 E81E E8DB D37C F64F FE73 ECA0 2FED 0EFD 162F \
2851 AAF4 6314 76C0 AB53 105F E481 D92A EDBC 735E C5F2 9CD0 \
2CC4 2C09"
```

Defining the TCP/IP port number on the `VENDOR` row may slow down the restart time of Tekla Licensing Service.

5. Save the changes and close `tekla.lic`.
6. Update your license server with the changes:
 - a. Go to **Tekla Licensing** --> **LMTTOOLS** through the **Start** menu or **Start screen**, depending on your Windows operating system.
 - b. On the **Service/License File** tab, ensure that **Configuration using services** and Tekla Licensing Service are selected.

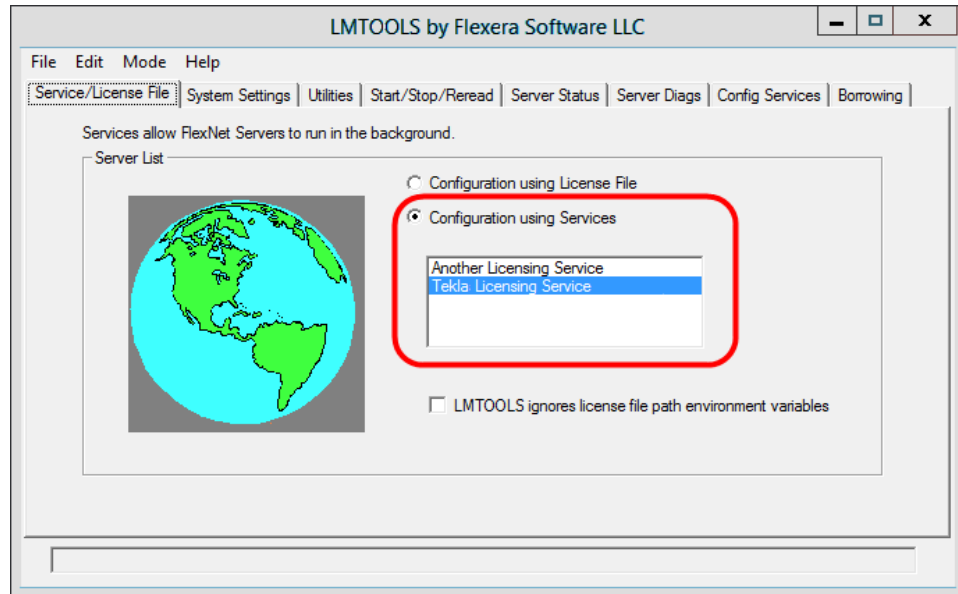

- c. Go to the **Start/Stop/Reread** tab and click **Stop Server** to stop the license server, and then start the server again by clicking **Start Server**.
7. Click the Windows logo key on your keyboard to show the **Start** menu or **Start screen**, depending on the operating system.
8. Type `wf.msc` and press **Enter**. The **Windows Firewall with Advance Security** MMS snap-in is displayed.
9. In the navigation tree, select **Inbound Rule**, and then in the **Actions** pane, click **New Rule**.

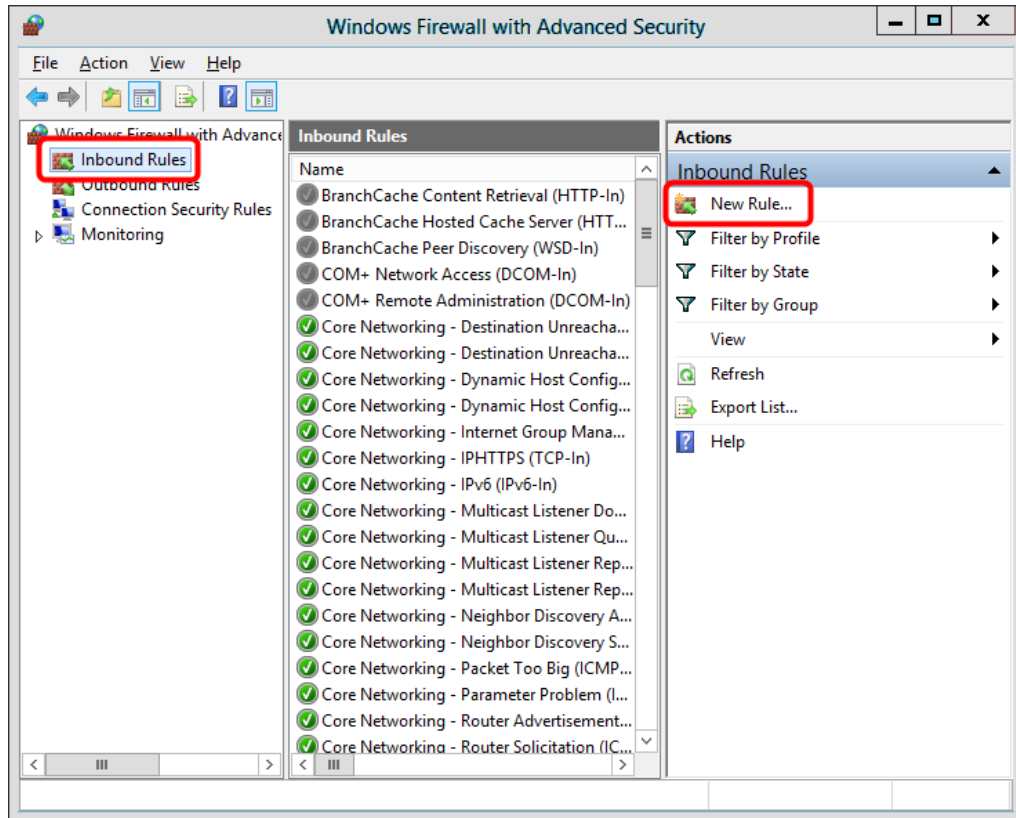

10. On the **Rule type** panel, select **Port** and then click **Next**.

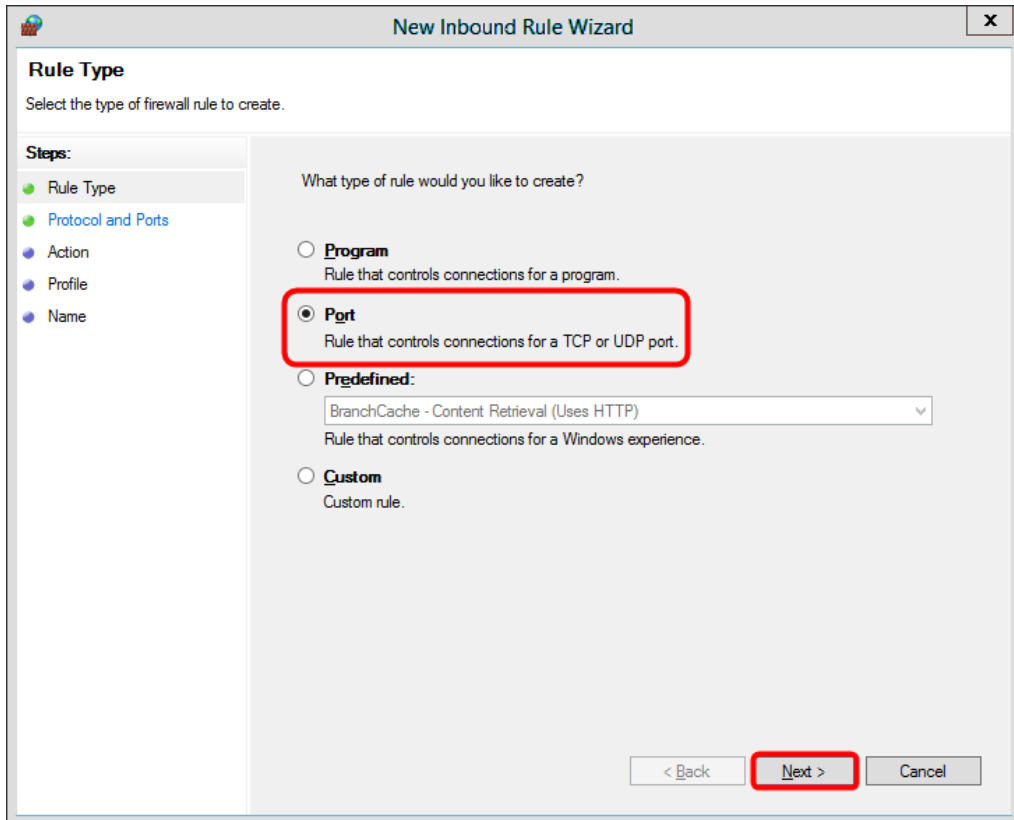

11. On the **Protocol and Ports** panel, select **TCP**, enter the TCP/IP port numbers that you set in steps 3 and 4 in **Specific local ports**, and then click **Next**.

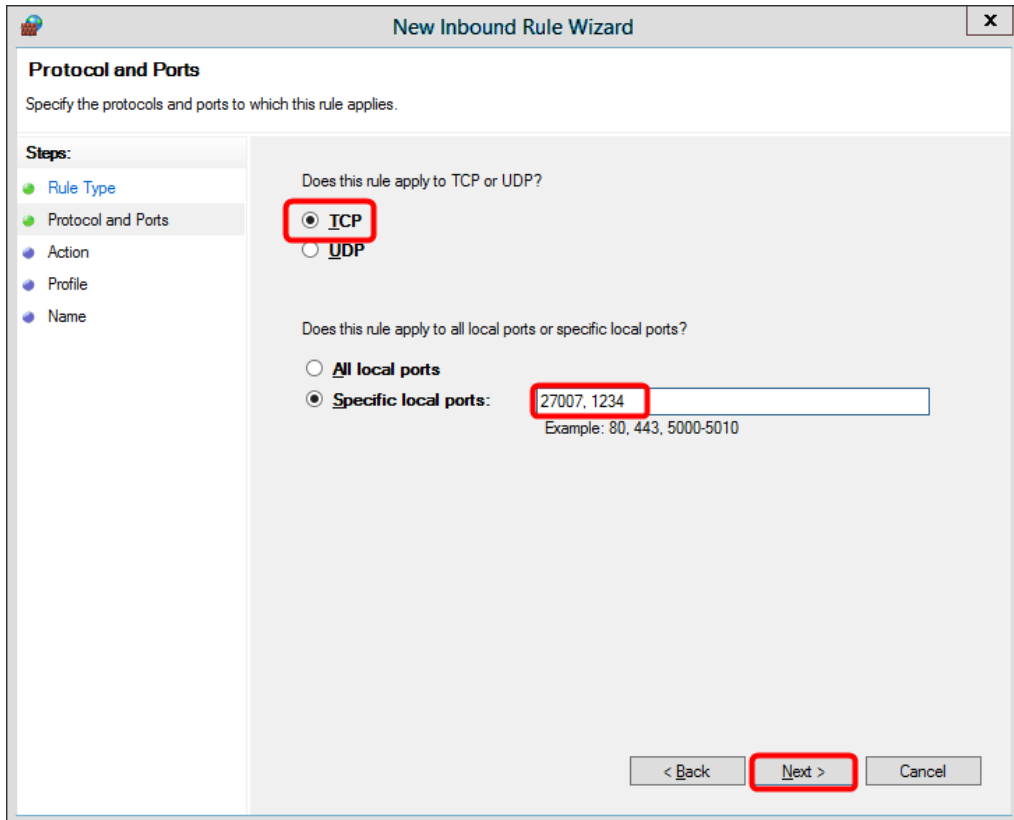

12. On the **Action** panel, select **Allow the connection**, and then click **Next**.

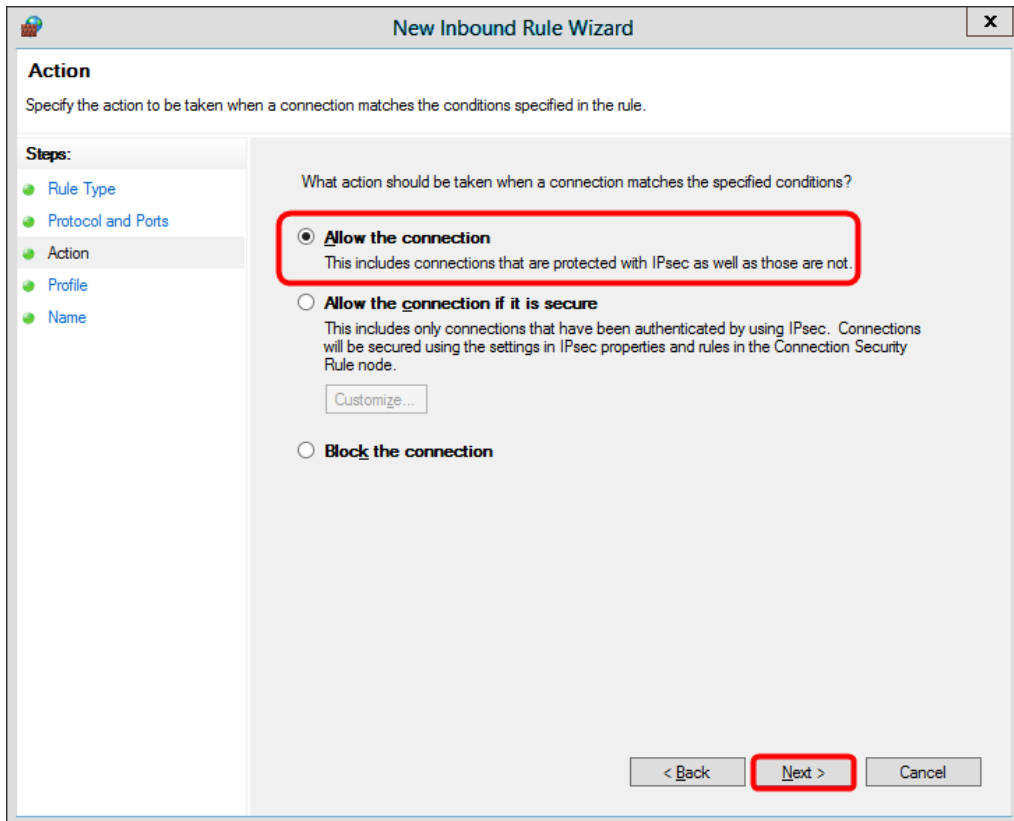

13. On the **Profile** panel, select the appropriate profiles, and then click **Next**.

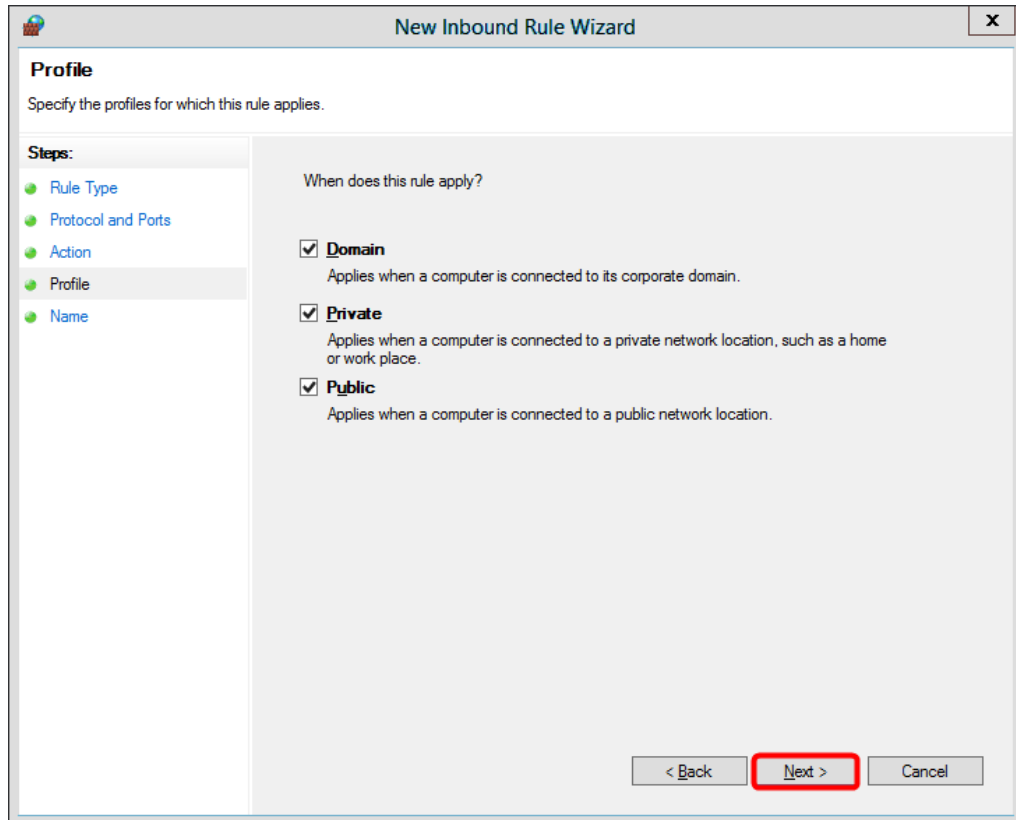

14. On the **Name** panel, enter the name of the rule, and then click **Finish**.

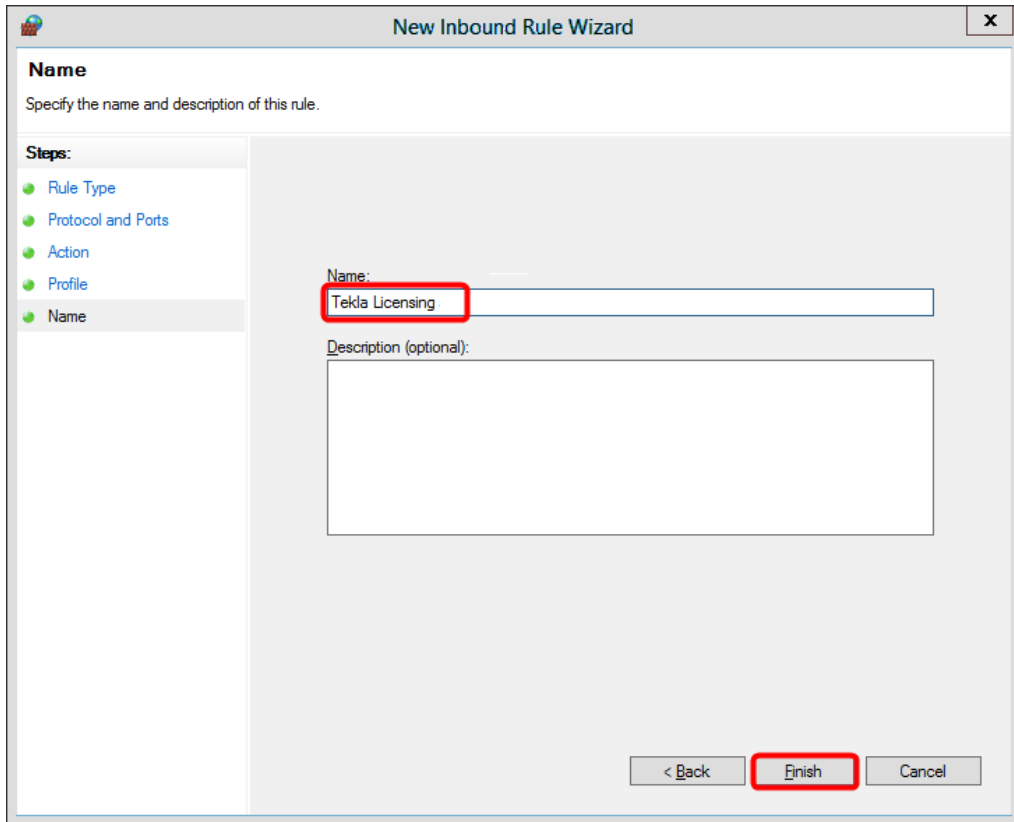

The rule is created and automatically enabled.

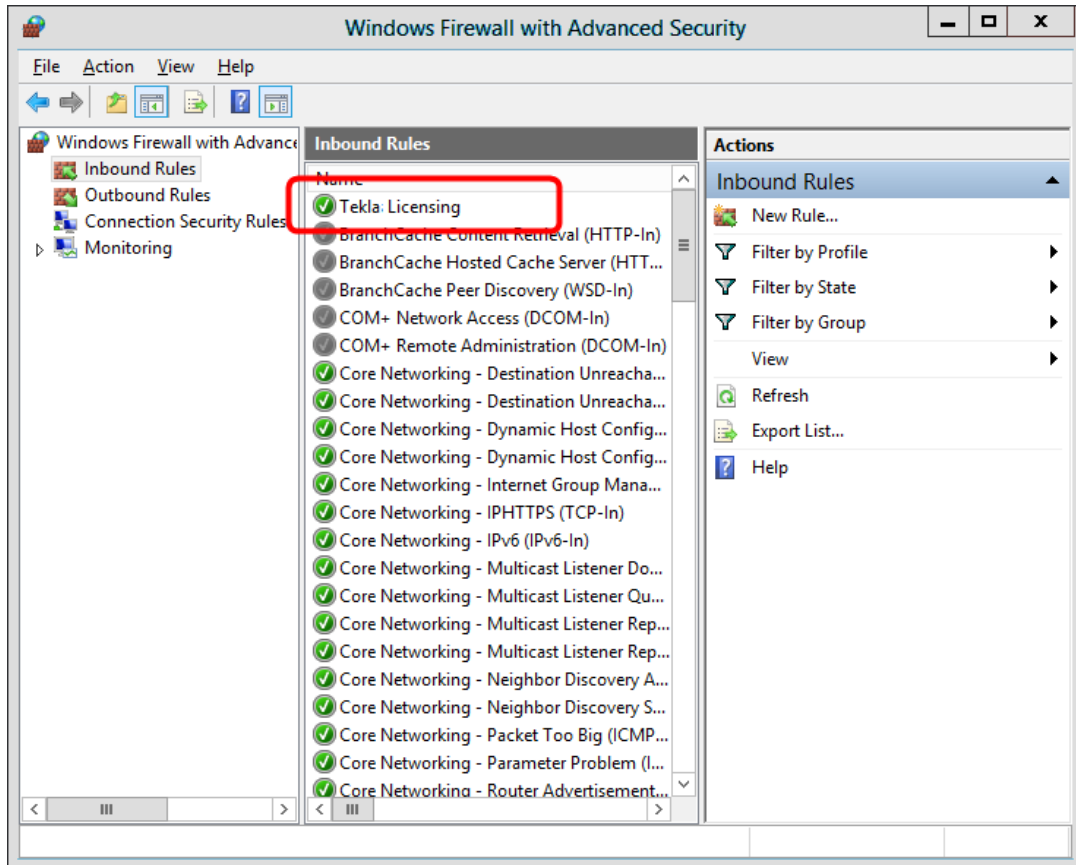

Tekla Structures

[Allow exceptions in firewall for Imgrd.exe and tekla.exe \(page 55\)](#)

[Allowing Tekla on-premises license server to operate through Windows Firewall \(page 54\)](#)

3.4 Activate on-premises licenses

You need to activate the on-premises licenses on the license server to be able to use them.

How license activation works

When you activate on-premises licenses, your license server contacts the activation server at Trimble Solutions, and the license rights are transferred to the license server in your company network or on your computer. You can

activate licenses in Tekla License Administration Tool, which is installed together with the license server.

- Internet access is required in license activation because the license server at your company needs to contact the activation server at Trimble Solutions.
- The activation server at Trimble Solutions tracks the activation status of your licenses. You are not allowed to activate any version of the same license again without first deactivating it. Deactivate the licenses before you make any major changes to the computer that runs the Tekla license server.
- You do not need to activate all the licenses at once. You can activate part of the licenses now and part of the licenses later on some other computer, for example. Different configurations and different versions need to be selected for activation separately.

Activate licenses

To activate an on-premises license, you must have the corresponding license entitlement certificate file `EntitlementCertificate.html`. The entitlement certificate is sent in an e-mail to the person in your organization who has made the license purchase, or to someone they have named as the contact person. The entitlement certificate states the configurations, quantities and identifiers of the licenses you are entitled to use.

- We recommend that you save the entitlement certificate file `EntitlementCertificate.html` to the `..\Tekla\License\Server` folder. You will need the file again if you later need to move the licenses to a different computer.

If you have licenses in several entitlement files, rename the files as necessary to avoid overwriting.

- You can activate licenses using either **manual** or **automatic** server notification. Do not use automatic notification if you are using some other FlexNet license and license server administration tool, such as FlexNet Manager. Otherwise, we recommend using automatic notification. You can find the instructions for both procedures below.

Activate on-premises licenses using automatic server notification

You can activate Tekla Structures on-premises licenses in Tekla License Administration Tool, which is included in the license server installation. To activate the license, the license server at your company contacts the activation server at Trimble Solutions through the internet. Tekla Structures subscriptions do not need to be activated.

NOTE Do not use automatic notification if you are using some other FlexNet license and license server administration tool, such as FlexNet Manager. To notify the license server about license changes manually, see Activate on-premises licenses.

To activate the licenses and notify the license server automatically:

1. Go to **Tekla Licensing** --> **Tekla License Administration Tool** through the **Start** menu or **Start screen**, depending on your Windows operating system.
2. Make sure the automatic license server notification is enabled. Check the status on the  **Notify Server** button in the toolbar and click the button if necessary.
3. Click **Open** and open the `EntitlementCertificate.html` file that contains the license. The license information is displayed in the **Entitled Licenses** area.

Entitled Licenses									
Activate	Quantity	Order ID	Activation ID	Description	Configuration	Version	Type	Start Date	Expiration Date
	1	Tekla HQ	04C1-3F1E-5...	FUD-C	Full	20		1.5.2015	31.5.2015
	2	Tekla HQ	4B73-A2E9-...	STD-C	SteelDetailing	20		1.5.2015	31.5.2015

4. Click the **Activate** cell and select the number of licenses to activate.

Entitled Licenses									
Activate	Quantity	Order ID	Activation ID	Description	Configuration	Version	Type	Start Date	Expiration Date
1	1	Tekla HQ	04C1-3F1E-5...	FUD-C	Full	20		1.5.2015	31.5.2015
	2	Tekla HQ	4B73-A2E9-...	STD-C	SteelDetailing	20		1.5.2015	31.5.2015

5. Click the **Activate** button.

Your license server contacts the license activation server at Trimble Solutions.

- The activated licenses are displayed in the **Activated Licenses** area.
- We recommend that you back up the trusted storage (`.\ProgramData\FLEXnet\`) in a safe place away from the computer running the license server. Backups can help you restore your licenses on the same server if active licenses are accidentally erased.
- When you open Tekla License Administration Tool later on, it detects expired and broken licenses you may have and asks if you want to deactivate or repair them. If you select **Yes**, an automatic deactivation or repair is run.

See also

[Problems in Tekla license activation \(page 86\)](#)

[Problems in Tekla licensing: Error codes and their descriptions \(page 97\)](#)

Activate on-premises licenses using manual server notification

You have to use manual notification if you are using some other FlexNet license and license server administration tool, such as FlexNet Manager.

To activate the licenses and notify the server manually:

1. Go to **Tekla Licensing** --> **Tekla License Administration Tool** through the **Start** menu or **Start screen**, depending on your Windows operating system.
2. Make sure the automatic license server notification is disabled. Check the status on the  **Notify Server** button in the toolbar and click the button if necessary.
3. Click **Open** and open the `EntitlementCertificate.html` file that contains the license. The license information is displayed in the **Entitled Licenses** area.

Entitled Licenses									
Activate	Quantity	Order ID	Activation ID	Description	Configuration	Version	Type	Start Date	Expiration Date
	1	Tekla HQ	04C1-3F1E-5...	FUD-C	Full	20		1.5.2015	31.5.2015
	2	Tekla HQ	4B73-A2E9-...	STD-C	SteelDetailing	20		1.5.2015	31.5.2015

4. Click the **Activate** cell and select the number of licenses to activate.

Entitled Licenses									
Activate	Quantity	Order ID	Activation ID	Description	Configuration	Version	Type	Start Date	Expiration Date
1	1	Tekla HQ	04C1-3F1E-5...	FUD-C	Full	20		1.5.2015	31.5.2015
	2	Tekla HQ	4B73-A2E9-...	STD-C	SteelDetailing	20		1.5.2015	31.5.2015

5. Click the **Activate** button.
Your license server contacts the license activation server at Trimble Solutions.
6. Next, you need to notify the server. This has to be done each time you activate a license.
 - a. Go to **Tekla Licensing** --> **LMTTOOLS** through the **Start** menu or **Start screen**, depending on your Windows operating system.
 - b. On the **Service/License File** tab, ensure that **Configuration using services** and Tekla Licensing Service are selected.
 - c. In the **LMTTOOLS** dialog box, go to the **Start/Stop/Reread** tab.
 - d. Click **ReRead License File**.

The license server reads the license information.

- The activated licenses are displayed in the **Activated Licenses** area.
- We recommend that you back up the trusted storage (`.. \ProgramData \FLEXnet \`) in a safe place away from the computer running the license

server. Backups can help you restore your licenses on the same server if active licenses are accidentally erased.

- When you open Tekla License Administration Tool, it detects expired and broken licenses you may have and asks if you want to repair or deactivate them. If you select **Yes**, an automatic deactivation or repair is run.

See also

[Problems in Tekla license activation \(page 86\)](#)

[Problems in Tekla licensing: Error codes and their descriptions \(page 97\)](#)

3.5 Preconfigure license server settings for users

When the license server is on a separate server in the network, Tekla Structures connects to the license server to fetch a license. To be able to do this, the license server address must be defined on each computer. This can be done by typing in the address when starting the software for the first time or you can include the address in an initialization file that you distribute as part of your customized installation. You can also predefine the license, environment and role with a customized startup shortcut and initialization file.

By default, when Tekla Structures starts for the first time on a computer, the system asks for the address of your Tekla license server unless Tekla Structures can find a license server with an active license installed on the same computer. To avoid this manual process, you can include the Tekla license server address in your customized configuration. Similarly, you can also select the license for the user, and if you also preset the environment and role, the user does not need to make any selections when starting Tekla Structures. To

set up this for your users, see the instructions in [Implementation guide for administrators \(page 111\)](#).

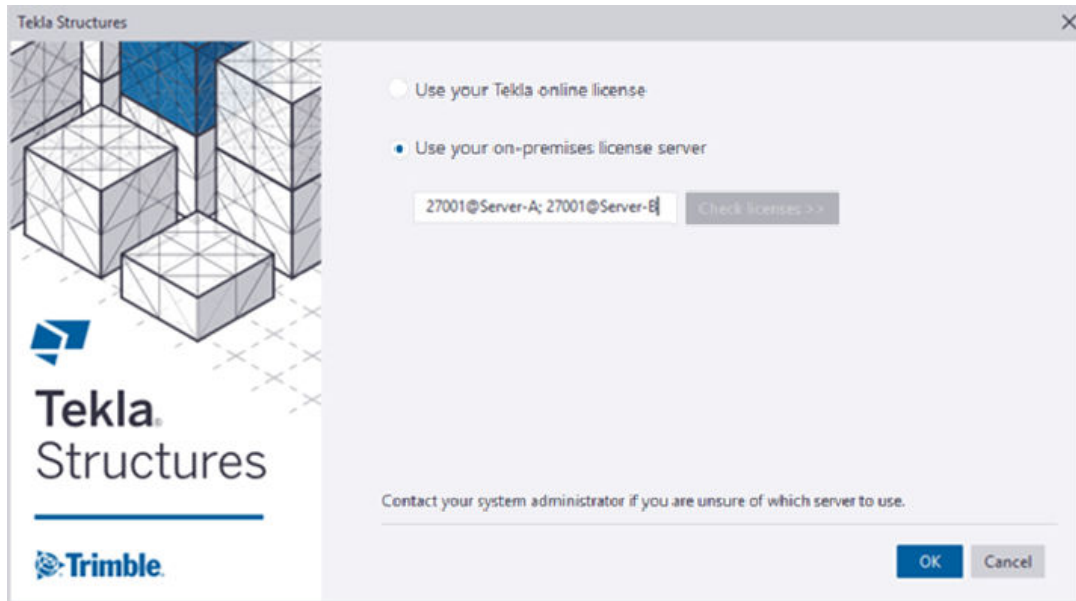

See also

[Modify the license file tekla.lic manually \(page 51\)](#)

3.6 Deactivate on-premises licenses

License deactivation releases license rights from a license server, which allows you to activate a new version of the same license or to activate the same license on different hardware. There is no deactivation for Tekla Structures subscriptions.

The activation server at Trimble Solutions tracks the activation status of your on-premises licenses. You are not allowed to activate any version of the same license again without first deactivating it.

When you deactivate licenses, your license server contacts the activation server at Trimble Solutions, and the license rights are transferred away from your Tekla license server.

When you need to deactivate licenses

- Before you upgrade or reinstall the operating system or before you change the hardware components of any computer that has a license server installation with active licenses.
- Before you activate a replacement license, including licenses that entitle you to run a new version of Tekla Structures and replacement licenses for any temporary licenses.

- Before you activate the same license on a different license server, for example, when you want to change from one license server computer to another.
- Before you change the IP address on the license server computer.
- Before you format the hard drive of or decommission your server computer.

When you do not need to deactivate licenses

You do not need to deactivate licenses before uninstalling and reinstalling the Tekla license server software.

Deactivate on-premises licenses

The information on this page is not valid for online subscriptions.

- Internet access is required in license deactivation.
- Deactivation must be done on the license server containing the active license. If your license server fails and cannot be recovered, contact your local support for assistance.

To deactivate licenses:

1. Start the Tekla License Administration Tool app with administrator rights. This tool is installed together with the Tekla license server and you can find it through the Windows **Start** menu on the computer that is hosting your license server.
2. In the **Tekla License Administration Tool** dialog box, go to the **Statistic** tab and ensure that no one is using the licenses.

License server statistics					
Configuration	Description	Total	In Use	Borrowed	Free
SteelDetailing	STD-C	1	0	0	1

NOTE Before you deactivate licenses, ensure that the licenses are not in use or borrowed. The borrowed licenses must be returned before they can be deactivated.

3. If you have not activated the automatic server notifications (the **Notify Server** option in **Tekla License Administration Tool**), you need to stop the license server manually in **LMTOOLS**:
 - a. Go to **Tekla Licensing** --> **LMTOOLS** through the **Start** menu or **Start screen**, depending on your Windows operating system. Start **LMTOOLS** with administrator rights.

- b. On the **Service/License File** tab, ensure that **Configuration using services** and Tekla Licensing Service are selected.
 - c. Go to the **Start/Stop/Reread** tab and click **Stop Server**.
4. In **Tekla License Administration Tool**, go to the **Licenses** tab.
The **Activated Licenses** area lists the active licenses.

Activated Licenses											
Deactivate	Trust Status	Enabled	Quantity	Borrowed	Configuration	Version	Expiration Date	Type	Activation ID	Order ID	
<input type="checkbox"/>			1	0	SteelDetailing	20	31.5.2015	Enter...	4B73-A2E9-...	Tekla HQ	

5. Select the **Deactivate** check box to select the license for deactivation.
If you activated more than one license of the same type in one go, you cannot deactivate those licenses one by one, but you need to deactivate all of the licenses in one go.
6. The **Deactivate** button is activated, click it.

The license server contacts the activation server at Trimble Solutions. Internet access is required at this stage. After a successful deactivation you will see the *license successfully deactivated* message, and the **Tekla License Administration Tool** is updated to reflect the deactivation.

See also

[Problems in Tekla license deactivation \(page 90\)](#)

[Problems in Tekla licensing: Error codes and their descriptions \(page 97\)](#)

3.7 Maintain Tekla licenses and subscriptions

After the licensing is set up, you can verify that you have the correct number of licenses and that the licenses are used correctly.

- With Tekla Structures subscriptions, you can monitor both current subscription users and view statistics of past usage in the [Tekla Online Admin Tool](#).
- With on-premises licenses, you can [monitor who is currently using licenses \(page 73\)](#).

You need to make changes in the following situations:

- If users are selecting incorrect license types or secondary users are reserving too many licenses, you can ensure that the correct types of

licenses are available to the users who most need them by defining access rights for using licenses.

With Tekla Structures subscriptions, you can adjust subscription access in the [Tekla Online Admin Tool](#).

For adjusting on-premises license usage, see [Modify on-premises license access rights \(tekla.opt\) \(page 74\)](#).

- If you have on-premises licenses, you need to [deactivate your existing licenses \(page 70\)](#):
 - When you start using a new version of Tekla Structures, which requires activating renewed licenses.
 - Before you activate a changed version of the same license (for example, the number of concurrent users is changed).
 - Before you make hardware changes that affect the license server.
 - If you want to [move the licenses to a different license server \(page 79\)](#).
- If your on-premises licenses become untrusted or disabled, you can repair them a limited number of times as explained in [Repair an on-premises license \(page 80\)](#).

See also

[Troubleshoot Tekla licensing \(page 81\)](#)

Monitor Tekla Structures license use

With on-premises licenses, you can view current license usage using the LMTOOLS application that is delivered with the Tekla license server.

The LMTOOLS application requires Windows administrator privileges to run.

When you use Tekla Structures subscriptions, you can monitor both current subscription users and view statistics about past usage in the [Tekla Online Admin Tool](#). For more information, see [Manage user accounts for Tekla products](#).

To view which licenses are currently in use:

1. Go to **Tekla Licensing** --> **LMTOOLS** through the **Start** menu or **Start screen**, depending on your Windows operating system.
2. If the correct Tekla license server is not defined, switch to the **Utilities** tab and add the license server path:
 - a. Type `tekla` in the **Vendor Name** box.
 - b. Type your license server address as `port@host` in the **Path** box.
 - c. Click **Override Path**.

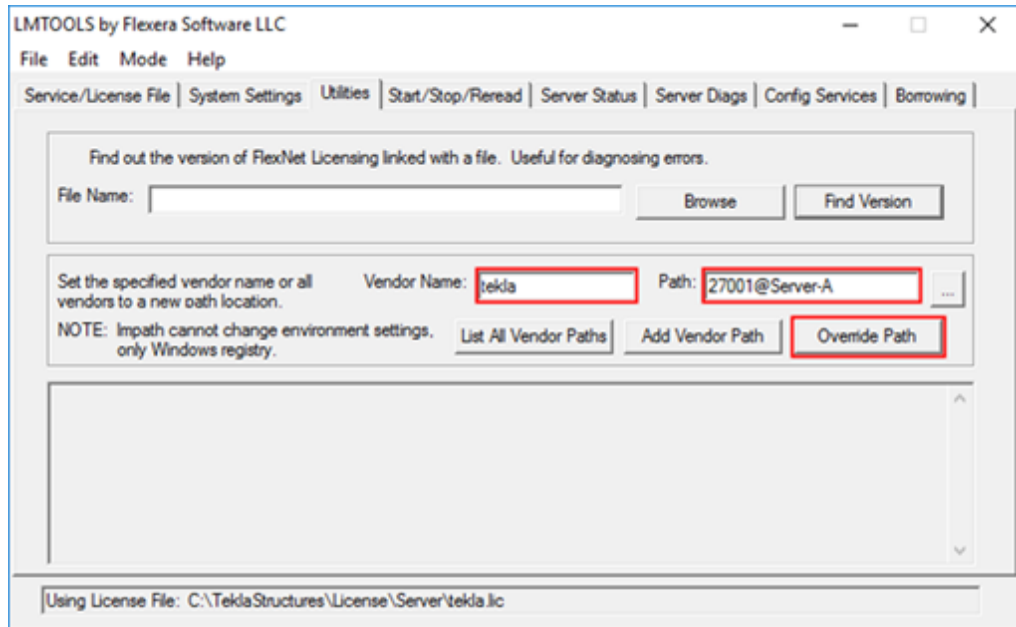

3. On the **Server Status** tab, click **Perform Status Enquiry**. You will receive a listing of how many licenses and which configurations are activated on the server, and how many of the licenses are in use at the moment of inquiry.

The status inquiry uses abbreviations of Tekla Structures configurations, [which are explained here \(page 76\)](#). You can also find the description of the abbreviations in your entitlement certificate or in Tekla License Administration Tool.

For a comprehensive description of the status inquiry syntax, see LMTOOLS options and settings used in Tekla licensing.

Modify on-premises license access rights (tekla.opt)

The Tekla Structures on-premises license server administrator may grant different users and user groups different rights to use licenses by modifying the `tekla.opt` options file. This can prevent situations where there are no licenses available for users that need them because someone else has reserved or borrowed a license that they do not really need.

The information on this page is not valid for online subscriptions.

The licensing options file `tekla.opt` is located in the `..\Tekla\License\Server` folder.

The most common configuration options include the following:

- You can define the access rights for specific usernames or hostnames/IP addresses either individually or using groups that you define. You can use the same username or hostname in several groups.
- You can **reserve** a number of licenses for a specific configuration (e.g., Steel detailing) for exclusive use by a specific user or user group. If necessary, the users in the group can reserve more licenses than the reserved quota. Other users can only use one of the remaining free licenses outside the reserved quota.
- You can define a maximum (**max**) number of licenses that a user or group can simultaneously use. Users who are not included in this limitation can use any free license.
- You can **include** (allow) a user or group in the exclusive use of all licenses for a specific configuration. Other users are prevented from using the configuration.
- You can **exclude** (disallow) specific users from using any licenses for a specific configuration. All other users are allowed to use the configuration.
- You can include and exclude users from borrowing licenses.

To modify access rights in the `tekla.opt` file:

1. Go to the `..\Tekla\License\Server` folder.
2. Open the `tekla.opt` file in a text editor.
3. Enter your definitions for license access rights and restrictions.

The definition string consists of the following parts: `[keyword] [Tekla Structures feature] [user type] [name]`

When you write the definition, follow the rules below.

- Note that the options file is case sensitive.
- If you need to define user groups and host groups, define them first.
Use Windows user names when defining user groups and hostnames or IP addresses when defining host groups.
- Enter one definition per row. A definition consists of the following things:
 - An options keyword that defines the actions.
 - A feature, such as a configuration, that is affected by the keyword.
 - The type that is affected by the keyword.
The options are: `USER`, `GROUP`, `HOST`, and `HOST_GROUP`.
 - The name of the user, user group, host, or host group that is affected by the keyword.

You can use the hostnames or IP addresses of the computers with the `HOST` and `HOST_GROUP` keywords.

- To disable a row in the options file, enter # in the beginning of the row.

Examples of definitions:

INCLUDE PCD-C USER scarlett (Only the user scarlett is allowed to use the **Precast Concrete Detailing** configuration.)

RESERVE 1 RCD-C USER vera (One license of the **Rebar Detailing** configuration is reserved for the user vera.)

For details about the allowed keywords and configuration codes together with more examples, [Configuration codes and keywords used in access right definitions \(page 76\)](#).

4. Save the changes and close the text editor.
5. Go to **Tekla Licensing** --> **LMTOOLS** through the **Start** menu or **Start screen**, depending on your Windows operating system.
6. In **LMTOOLS**, go to the **Start/Stop/Reread** tab and click the **ReRead License File** button to update the changes in the license file and in the options file.

Useful links

For more information about limiting certain Tekla Structures versions to certain users, see the following Support Article in Tekla User Assistance: [How to limit certain Tekla Structures version to certain users](#)

Configuration codes and keywords used in access right definitions

When you define access rights in `tekla.opt`, you need to use correct abbreviations (codes) for the configurations, otherwise the definitions do not work. The access rights are defined using certain keywords.

Configuration codes

When you define access rights for different Tekla Structures configurations in the `tekla.opt` options file, you need to add a proper code for each configuration in the definition.

NOTE The configuration codes are backward compatible, and the codes used for licensing in older Tekla Structures versions still work. However, the commercial product name of the configuration may change between versions. For example, the commercial product name for STD-L used to be Steel Detailing Limited, but now it is Primary.

The codes for the Tekla Structures configurations are listed below:

Configuration code	Configuration
CM-C	Construction Modeling
DEV-C	Developer

Configuration code	Configuration
DFR-C	Drafter
EDU-C	Educational
FUD-C	Full
PCD-C	Precast Concrete Detailing
RCD-C	Rebar Detailing
SDE-C	Engineering
STD-C	Steel Detailing
PPC-C	Production Planner for Concrete
STDL-C	Primary
VIE-C	Project Viewer

Most common keywords

The most common keywords that are used for defining license access rights and restrictions in the `tekla.opt` options file are listed and described below:

Keyword	Description	Usage information
EXCLUDE	Prevent access to a Tekla Structures configuration.	Use with the abbreviation of the configuration.
EXCLUDE_ENTITLEMENT	Prevent license borrowing.	Use with the activation ID of the license.
EXCLUDEALL	Prevent access to all Tekla Structures configurations.	
GROUP	Define a user group for use with any options.	Use with Windows user names (separated with spaces).
HOST_GROUP	Define a host group for use with any options.	Use with computer hostnames or IP addresses (separated with spaces).
INCLUDE	Allow a user to use a Tekla Structures configuration.	Use with the abbreviation of the configuration.
INCLUDE_ENTITLEMENT	Allow a user to borrow a license.	Use with the activation ID of the license.
INCLUDEALL	Allow a user to use all Tekla Structures configurations.	
MAX	Limit the usage of a configuration.	Use with the number of licenses and the

Keyword	Description	Usage information
		abbreviation of the configuration.
RESERVE	Reserve licenses for a user/host or a group of users/hosts.	Use with the number of licenses and the abbreviation of the configuration.

- When somebody is allowed to use a configuration with the `INCLUDE` keyword, other users are automatically prevented from using the configuration.
- When somebody is denied to use a configuration with the `EXCLUDE` keyword, other users are automatically allowed to use the configuration.
- If no rules exist, everybody is allowed to use the configuration.

Some examples of definitions in a `tekla.opt` options file are given below:

Options file definition	Description
<code>INCLUDE PCD-C USER scarlett</code>	Only the user scarlett is allowed to use the Precast Concrete Detailing configuration.
<code>EXCLUDE FUD-C USER justin</code>	The user justin is not allowed to use the Full configuration. Other users are allowed to use the Full configuration.
<code>GROUP tsusers jessica joe neil INCLUDEALL GROUP tsusers</code>	The users jessica , joe and neil belong to the group tsusers . Only the group tsusers is allowed to use all configurations.
<code>EXCLUDEALL HOST pcrobert</code>	No configuration is allowed to be used on the computer pcrobert .
<code>INCLUDE_ENTITLEMENT qwer-1234-asdf-5678-zx USER gwen</code>	Only the user gwen is allowed to borrow a license whose activation ID is qwer-1234-asdf-5678-zx .
<code>EXCLUDE_ENTITLEMENT rtyu-9876-fghj-5432-cv USER matt</code>	The user matt is not allowed to borrow a license whose activation ID is rtyu-9876-fghj-5432-cv .
<code>GROUP students amy chloe andy dean MAX 3 EDU-C GROUP students</code>	The users amy , chloe , andy , and dean belong to the group students . The limit to the usage of the Educational configuration for the group students is three licenses.
<code>RESERVE 1 RCD-C USER vera</code>	One license of the Rebar Detailing configuration is reserved for the user vera .

Options file definition	Description
<pre>GROUP STUDENTS user1 user2 user3 RESERVE 3 VIE-C GROUP STUDENTS</pre>	<p>The users user1 user2 user3 belong to the group STUDENTS. 3 licenses of the Project Viewer configuration are reserved for the group STUDENTS.</p> <p>STUDENTS is a group name.</p> <p>user1 - user 3 are Windows user names separated with spaces.</p> <p>The number 3 is the number of licenses to reserve.</p> <p>VIE-C is the configuration code for the Project Viewer configuration.</p> <p>Note that any licenses reserved for a group are dedicated to that group. Even when that group is not actively using the licenses, the licenses are unavailable to other users.</p>
<pre>INCLUDE VIE- C:VENDOR_STRING=Enterpris e USER john</pre>	<p>Only the user john is allowed to use the Project Viewer configuration which is of type Enterprise.</p>

Useful links

For more information about limiting certain Tekla Structures versions to certain users, see the following Support Article in Tekla User Assistance: [How to limit certain Tekla Structures version to certain users](#)

Move licenses between license servers

You can transfer an on-premises license from one license server to another. Moving licenses can be necessary, for example, if you are switching to new hardware or if you want to consolidate licenses from several workstations to a central server.

The information on this page is not valid for online subscriptions.

1. [Deactivate the licenses that you want to move \(page 70\)](#) in the Tekla License Administration Tool on the computer that currently contains the licenses.

Activated Licenses											
	Deactivate	Trust Status	Enabled	Quantity	Borrowed	Configuration	Version	Expiration Date	Type	Activation ID	Order ID
				1	0	SteelDetailing	20	31.5.2015	Enter...	4B73-A2E9-...	Tekla HQ

2. If the license entitlement certificate file containing these licenses is not available on the other computer, find the `EntitlementCertificate.html` file that contains the license and copy it to the computer on which you want to activate the licenses.

- Entitlement certificate files are sent over email. In the installation instructions, we recommend storing the entitlement files in the license server installation folder (. . \Tekla\License\Server\), from where you can copy it to the same folder on the other computer.
 - Rename the files as necessary to avoid overwriting different entitlement certificate files with each other.
 - There can be several licenses in one file, so you can activate different licenses on different computers using the same entitlement certificate file.
3. [Activate the licenses \(page 65\)](#) in the Tekla License Administration Tool on the other computer to complete the move.

Entitled Licenses									
Activate	Quantity	Order ID	Activation ID	Description	Configuration	Version	Type	Start Date	Expiration Date
	1	Tekla HQ	04C1-3F1E-5...	FUD-C	Full	20		1.5.2015	31.5.2015
1	2	Tekla HQ	4B73-A2E9-...	STD-C	SteelDetailing	20		1.5.2015	31.5.2015

We recommend that you back up the trusted storage (. . \ProgramData \FLEXnet\) in a safe place away from the computer running the license server. Backups can help you restore your licenses on the same server if active licenses are accidentally erased.

See also

[Installing Tekla on-premises license server \(page 45\)](#)

Repair an on-premises license

If your on-premises licenses have become untrusted or disabled, they cannot be used and you need to repair them.

The information on this page is not valid for online subscriptions.

The license trust status is indicated in the **Activated Licenses** area in Tekla License Administration Tool. If a trust status symbol is green, the information is trusted, if red, the information is untrusted.

WARNING Because of technical and security reasons, you can repair an Activation ID only a limited number of times, which at the moment is two times a year. Therefore it is important that you inform your local Tekla Structures representative about the license repairs you have been performing, and keep count of the repairs.

The status can be one of the following:

- A red **H (Host)** indicates whether the server has been moved to another computer, or whether the computer hardware has changed radically.

The **Host** trust status of your license is not trusted:



NOTE Licenses that have the **Host** trust status untrusted cannot be repaired.

- A red **T (Time)** indicates whether the system clock has been tampered with. The **Time** trust status of your license is not trusted:



- A red **R (Restore)** indicates whether the license is obtained from a backup copy. The **Restore** trust status of your license is not trusted:



To repair a license:

1. Go to **Tekla Licensing** --> **Tekla License Administration Tool** through the **Start** menu or **Start screen**, depending on your Windows operating system.
The **Activated Licenses** area displays the activated licenses.
2. Click **Repair**.
The license server contacts the activation server at Trimble Solutions. After successful repairing the trust status in Tekla License Administration Tool dialog box is updated.

Troubleshoot Tekla licensing

Click the links below for help in solving problems encountered in the following areas:

- [View and diagnose errors in Tekla Structures license activation, deactivation and borrowing \(page 82\)](#)
- [Problems in Tekla license server installation and connecting to the license server \(page 82\)](#)
- [Problems in FlexNet \(page 85\)](#)
- [Problems in Tekla license activation \(page 86\)](#)
- [Problems in Tekla license deactivation \(page 90\)](#)
- [Problems in Tekla license borrowing \(page 90\)](#)
- [Problems in Tekla license trusted storage \(page 91\)](#)

- [Problems using LMTOOLS in Tekla licensing \(page 92\)](#)
- [Problems in starting Tekla Structures \(page 94\)](#)
- [Problems with options file tekla.opt \(page 96\)](#)

For more information about error messages starting with an error code, see [Problems in Tekla licensing: Error codes and their descriptions \(page 97\)](#).

View and diagnose errors in Tekla Structures license activation, deactivation and borrowing

Tekla License Administration Tool and Tekla License Borrow Tool both give error messages when errors occur. The tools automatically create packages of all necessary files required for diagnosing the errors.

If you have a problem with activating or deactivating licenses, or borrowing or returning licenses, Tekla License Administration Tool and Tekla License Borrow Tool display an error message in the **Activating License(s), Deactivating License(s), Borrowing License(s)** or **Returning Borrowed License(s)** dialog boxes, depending on the subject of the error.

- You can view more detailed information about an error by clicking the **View** button in an error dialog box.
- Tekla License Administration Tool and Tekla License Borrow Tool automatically create zip packages of all necessary files required for diagnosing the errors in the `C:\Tekla\License\Server\Reports` folder and in the `%TEMP%\Tekla License Borrow Tool\Reports` folder. Click **Browse** in the error dialog box to browse for the folder containing the error report package. You can send the package to your local support to get help.

The error report package contains the following files:

`tekla_debug.log` - Tekla license server debug log file

`error.txt` - error report, contains error information. The Tekla License Borrow Tool zip package only contains this file.

`tekla.opt` - access rights options file

`tekla.lic` - Tekla license file

See also

[Troubleshoot Tekla licensing \(page 81\)](#)

[Problems in Tekla licensing: Error codes and their descriptions \(page 97\)](#)

Problems in Tekla license server installation and connecting to the license server



License server installation fails, and the following message is displayed:
"A newer version of this application is already installed on this computer. If you wish to install this version, please uninstall the newer version first. Click OK to exit the wizard."

Reason: You have a newer version the license server installed.

Solution: You should not install an old version of the license server. Check the latest available license server release on the [Tekla Downloads](#) product download page.

The license server version is not dependent on Tekla Structures. However, if you need to use an older version of the license server for some reason, uninstall the newer version on your computer before installing the older version.



License server installation does not finish (no error message)

Reason: Another software using the FlexNet licensing system is running on the computer.

Solution: Stop all licensing services in **LMTOOLS**, then install the Tekla license server and restart the licensing services you stopped earlier:

1. Go to **Tekla Licensing** --> **LMTOOLS** through the **Start** menu or **Start screen**, depending on your Windows operating system.
2. On the **Service/License File** tab, ensure that **Configuration using services** is selected, select a license service from the services list, go to the **Start/Stop/Reread** tab and click **Stop Server**.
Do the same for all the services you need to stop.
3. Install the Tekla license server.
4. In **LMTOOLS**, start the licensing services you stopped earlier.



Problem in license server connection. The following message is displayed:
"Error when connecting to the license server. Contact your system administrator or try another server".

Reason: This problem is often related to firewall settings.

Solution: Check that your firewall allows the client to contact the license server.



License library initialization failed with error: The licensing service is not installed.

Reason: The error occurs when you are starting Tekla License Administration Tool, or when you are trying to run `serveractutil.exe` command line tool.

Solution: If you selected the **Manual** option for Tekla Licensing Service installation then you need to manually install FLEXnet licensing service:

1. If you have some other FlexNet licensing service running on the server, stop it before entering the commands.
2. Go to the **Start** menu or **Start screen**, depending on your Windows operating system, and open **Command Prompt** as an administrator.
3. At the command prompt, type the following commands:

```
cd /D full_path_to_installation_directory
```

For example, if you install Tekla license server to the default folder, you need to enter `cd /D C:\Tekla\License\Server`.

```
installanchorservice.exe
```



Cannot connect to the license server.

Solution: For the first time that you connect to the Tekla license server a client computer that has a new version of Tekla Structures installed, you need to do the following:

- Ensure that both (the client computer and the license server) are in the same domain.
- Ensure that Local Area Network connection is established. The license server and the client computers need to be in the same Local Area Network.
- Turn off the firewall and pause the antispysware/antivirus protection of your computer.

After the steps above do the following on your company's license server:

1. Make sure that no one is using Tekla Structures (ask all users to close Tekla Structures).
2. Go to `C:\Tekla\License\Server` and open the `tekla.lic` file in a text editor.
3. Add a free TCP/IP port for the licensing service at the end of the first row, if it does not exist by default. Note that the automatic installation option sets the port by default to 27007.

Example of the first row: `SERVER MYSERVER ANY 27007`, where `MYSERVER` is the license server and `27007` is the port.

4. Save and close the file after changes.
5. Go to **Tekla Licensing** --> **LMTOOLS** through the **Start** menu or **Start screen**, depending on your Windows operating system.
6. On the **Service/License File** tab, ensure that **Configuration using services** and Tekla Licensing Service are selected.
7. On the **Start/Stop/Reread** tab, click **Stop Server**. Wait couple of seconds and click on **Start Server**.

After defining the server and the port, do the following on your Tekla Structures workstations:

1. Start Tekla Structures.
2. When you are asked for a server, add the port to the front of the server definition and click **OK**.

Example: 27007@MYSERVER



Cannot start the Tekla licensing service.

Reason: The `tekla-debug.log` file may be locked, thus preventing the service from starting.

Solution: Delete the `tekla-debug.log` and restart the computer.

See also

[Problems in Tekla licensing: Error codes and their descriptions \(page 97\)](#)

[Installing Tekla on-premises license server \(page 45\)](#)

[Allowing Tekla on-premises license server to operate through Windows Firewall \(page 54\)](#)

Problems in FlexNet



An internal error occurred. FlexNet internal error.

Reason: There is a problem with the Tekla license server installation.

Solution: This error can often be fixed by performing the steps below:

1. Uninstall all existing Tekla license server installations.
2. Check that all the files are deleted from the Tekla license server installation folder: `.. \Tekla\License\Server`.
3. Install the latest Tekla license server. Check for the latest version in [Tekla Downloads](#).

See also

[Installing Tekla on-premises license server \(page 45\)](#)

[Problems in Tekla licensing: Error codes and their descriptions \(page 97\)](#)

Problems in Tekla license activation



The following message is displayed: "Error reading entitlement file".

Reason: The .NET Framework is not working for some reason.

Solution: Reinstall the existing .NET Framework, or install the latest .NET Framework version that is available for your operating system.



License activation fails, and the following message is displayed: "Unable to activate more licenses than you are entitled to".

Reason: There are a couple of possible reasons for the problem:

- You may have activated licenses on another computer. You cannot activate more licenses than you are entitled to.
- You tried to activate a renewed temporary license or a permanent license without deactivating the previous temporary license.

Solution: There are two possible solutions:

- Deactivate a license on another computer and then activate the license on your computer.
- Deactivate the existing temporary license and then activate the succeeding linked license.

For more information about deactivating licenses, see [Deactivate on-premises licenses \(page 70\)](#).



The amount of activated licenses in Tekla License Administration Tool and LMTOOLS does not match.

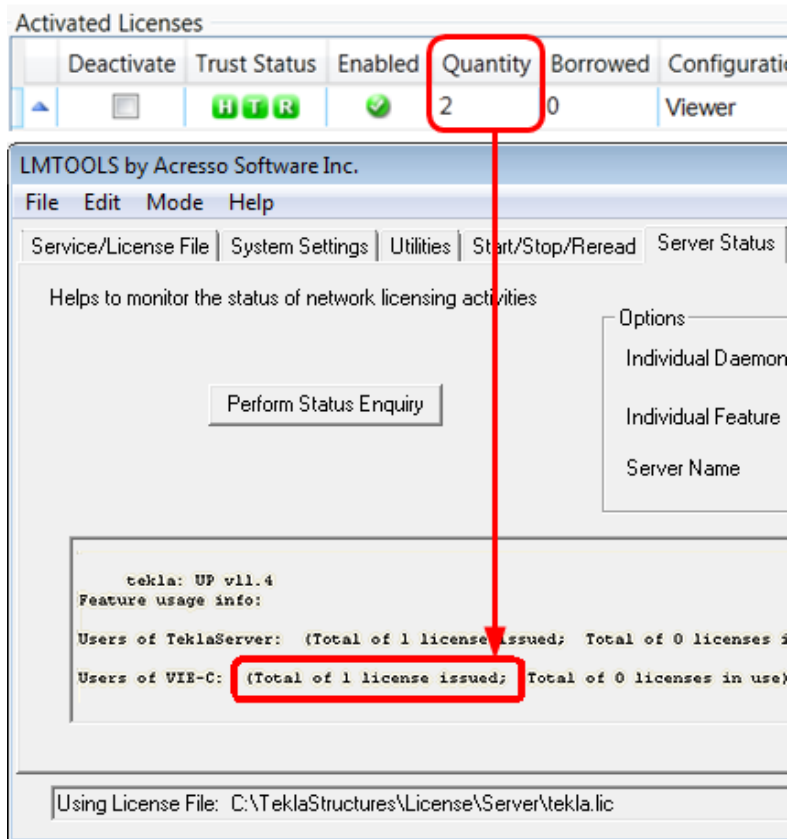

Reason: The licensing service is not updated with new license information.

Solution 1: Reread the license file in **LMTOOLS**:

1. Go to **Tekla Licensing** --> **LMTOOLS** through the **Start** menu or **Start screen**, depending on your Windows operating system.
2. On the **Start/Stop/Reread** tab, click **ReRead License File**.

Solution 2: If you are connected to several license servers, rereading the license file may not work. In that case, you need to stop the license server and then restart it in **LMTOOLS**:

1. Ensure that no one is using Tekla license server.
2. On the **Service/License File** tab, ensure that **Configuration using services** and Tekla Licensing Service are selected.
3. On the **Start/Stop/Reread** tab in **LMTOOLS**, select the **Force Server Shutdown** check box and click **Stop Server**.
4. Check that the status is "Stopping server". Wait for a few minutes.
5. Click **Start Server**, and ensure that "Server Start Successful" is displayed.

TIP To avoid the problem in the future, ensure that the license server is automatically notified when you activate, deactivate, or repair licenses.

To enable the automatic notification functionality in Tekla License Administration Tool, click the **Notify Server** button.

For more information about starting and stopping server and rereading the license file, see LMTOOLS options and settings used in Tekla licensing.

For more information about activating licenses, see [Activate on-premises licenses \(page 65\)](#).



No warning is displayed, even though the temporary license will expire within one month.

Reason: The expiry warning message appears only when someone uses the expiring license. Probably there are several permanent licenses (that have been activated first) and some temporary licenses that have been activated after the permanent ones.

When somebody starts Tekla Structures, the system uses licenses in the order of activation. For example, if you have 10 permanent and 2 temporary licenses, all 10 licenses must be in use before someone obtains the temporary license, and receives the warning about the expiring license.



When you try to open the entitlement certificate in Tekla License Administration Tool, nothing is shown.

Reason 1: You have not downloaded the attached entitlement certificate from your e-mail application, but opened the certificate in an Internet browser and saved it as an `.html` file from the browser.

Solution: Open the e-mail containing the entitlement certificate attachment `EntitlementCertificate.html`. Download the entitlement certificate to the `..\Tekla\License\Server` folder from e-mail. Then try to open it again in Tekla License Administration Tool by clicking **Open**.

For more information, see [Activate on-premises licenses \(page 65\)](#).

Reason 2: The virus protection system of your computer has removed the Trimble Solutions logo from the license entitlement certificate.

Solution: The sender of the entitlement certificate should zip the entitlement certificate file. Unzip the entitlement certificate file on the computer where the licenses are going to be activated.



License was activated successfully, but the following error message is

displayed when you run the command line command "serveractutil - view": "Activation library initialization failed."

Reason: The license server installation was not successful.

Solution: Do the following:

1. Stop other FlexNet licensing services in **LMTOOLS**.
2. Run the `installanchorservice.exe` at the command prompt, restart the license server.

After doing this you will be able to activate your licenses and use Tekla Structures.

If the above did not work, you need to uninstall the license server and reinstall the recent version once again with administrator rights.

For more information about uninstalling and installing the license server, see and [Installing Tekla on-premises license server \(page 45\)](#).



The automatic notification functionality in Tekla License Administration Tool does not work: nothing happens when you click the Notify Server button

Reason: One of the reasons why the **Notify Server** button does not work in Tekla License Administration Tool might be that Tekla Licensing Service is not started on the computer.

Solution: To solve the issue, open Windows **Control Panel** --> **Administrative Tools** --> **Services** . Ensure that the Tekla Licensing Service status is **Running** . The **Startup Type** of the service should be set either to **Automatic** or to **Automatic (Delayed Start)**.



Your licenses no longer appear as activated licenses, or old version licenses are activated, but they do not work.

Reason: Windows system restore may cause problems for licensing. For more information, see [Windows system restore might affect your model and licensing](#).

Useful links

For more information about the status of the activated licenses in the trusted storage, see instructions in the following Support Articles in Tekla User Assistance:

[Checking the status of the activated licenses in the trusted storage](#)

[Checking the status of the activated licenses in the trusted storage \(including borrowing info\)](#)

See also

[Problems in Tekla licensing: Error codes and their descriptions \(page 97\)](#)

Problems in Tekla license deactivation



Unable to select a license for deactivation.

Activated Licenses											
	Deactivate	Trust Status	Enabled	Quantity	Borrowed	Configuration	Version	Expiration Date	Type	Activation ID	Order ID
				1	1	SteelDetailing...	2018	15.11.2018	Enter...	4B73-A2E9...	Tekla HQ

Reason: You cannot select a license for deactivation if the license is still borrowed.

Solution: Return the license and then deactivate the license.

See also

[Problems in Tekla licensing: Error codes and their descriptions \(page 97\)](#)

[Deactivate on-premises licenses \(page 70\)](#)

Problems in Tekla license borrowing



Unable to select a date from the calendar in the Borrow Until box.

Reason: The maximum borrowing period is one month.

Solution: In Tekla License Borrow Tool, select a date that is within one month from the date of borrowing:

1. Go to **Tekla License Borrow** --> **Tekla License Borrow Tool** through the **Start** menu or **Start screen**, depending on your Windows operating system.
2. In the **Products** area, click the **Borrow Until** box and select from the calendar the expiration date that is within one month from the date of borrowing.



Tekla Structures does not start up with the borrowed license.

Problem: You borrowed a license and disconnected from the network. When you open Tekla Structures, the licensing dialog box is displayed, but Tekla Structures does not find the borrowed license.

Solution: If Tekla Structures does not start up with the borrowed license, please type only an asterisk character (*) into the server box in the licensing dialog box.

This will force Tekla Structures to search for all possible locations for the license. It might take some time until it finds the license.



The computer that is running a borrowed license crashed, what should I do?

Solution: If your computer only needs rebooting, you can use the borrowed license again after rebooting. If your computer completely breaks down, the license will automatically be available on the license server when the borrowing period expires.

See also

[Problems in Tekla licensing: Error codes and their descriptions \(page 97\)](#)

[Set up on-premises license borrowing for offline use \(page 104\)](#)

Problems in Tekla license trusted storage



A license cannot be used.



Reason: The **Host (H)** trust status of your license is not trusted. Hardware setup of your server computer has changed radically.

Solution: The licenses with the untrusted **H** trust status cannot be repaired. Contact your local support.

We recommend that you run your license server on a proper server computer that is regularly maintained. You need to deactivate your licenses before performing any maintenance actions on your server computer. However, unnecessary deactivations should be avoided due to technical and security reasons.

For more information, see [Repair an on-premises license \(page 80\)](#).



A license cannot be used.



Reason: The **Time (T)** trust status of your license is not trusted. Time settings of your server computer have changed radically.

Solution: You need to set the correct system date and time and after that repair the license in Tekla License Administration Tool.

Do not manipulate system clock settings of the server computer that has activated licenses.

For more information, see [Repair an on-premises license \(page 80\)](#).



A license cannot be used.

Trust Status



Reason: The **Restore (R)** trust status of your license is not trusted. Your backup system may have overwritten some licensing information.

Solution: You need to repair the license in Tekla License Administration Tool.

We recommend that you configure your system backup settings so that the existing licensing software, tools and files are not automatically overwritten or replaced with the restored ones.

For more information, see [Repair an on-premises license \(page 80\)](#).

See also

[Problems in Tekla licensing: Error codes and their descriptions \(page 97\)](#)

[Repair an on-premises license \(page 80\)](#)

Problems using LMTTOOLS in Tekla licensing



LMTTOOLS does not reread the license file.

Reason: Rereading the license file does not work if you are running a licensing service locally on your computer and you are connected to another license server at the same time.

Solution: You need to stop and restart the licensing service. Do the following:

1. Go to **Tekla Licensing** --> **LMTTOOLS** through the **Start** menu or **Start screen**, depending on your Windows operating system.
2. On the **Service/License File** tab, ensure that **Configuration using services** and Tekla Licensing Service are selected.
3. On the **Start/Stop/Reread** tab, click **Stop Server** and wait a few seconds for the service to stop.
4. Click **Start Server**.



LMTOOLS is unable to stop the license server, and the message "Unable to Stop Server" is displayed in the LMTOOLS message bar.

Reason: You may have selected an incorrect licensing service.

Solution: You need to select Tekla Licensing Service as the licensing service. Do the following:

1. Go to **Tekla Licensing --> LMTOOLS** through the **Start** menu or **Start screen**, depending on your Windows operating system.
2. On the **Service/License File** tab, ensure that **Configuration using services** and Tekla Licensing Service are selected.
3. Go to the **Start/Stop/Reread** tab, and click **Stop Server**.
4. If this does not help, select the **Force Server Shutdown** check box and click **Stop Server** again.



LMTOOLS is unable to stop the license server.

Reason: You did not run **LMTOOLS** with administrator rights.

Solution: Run **LMTOOLS** with administrator rights. For more information, see [Rights needed for administrator tasks in on-premises licensing \(page 38\)](#).



Starting or stopping the server or rereading the license file cannot be performed, and the message "No Server Selected" is displayed.

Reason: You have not selected the licensing service.

Solution: You need to select Tekla Licensing Service as the licensing service. Do the following:

1. Go to **Tekla Licensing --> LMTOOLS** through the **Start** menu or **Start screen**, depending on your Windows operating system.
2. On the **Service/License File** tab, ensure that **Configuration using services** and Tekla Licensing Service are selected.
3. Go to the **Start/Stop/Reread** tab and start or stop the server or reread the license file.



Starting or stopping the server or rereading the license file is not possible.

The status list in **LMTOOLS** indicates that the license server manager (lmgrd) has not been started: "Error getting status: Cannot connect to license server system. The license server manager (lmgrd) has not been started yet, the wrong port@hostname or license file is being used, or the port or hostname in the license file has been changed".

Reason: LMTOOLS points to the wrong lmgrd.exe.

Solution: You need to modify the settings in **LMTOOLS**. Do the following:

1. Go to **Tekla Licensing** --> **LMTOOLS** through the **Start** menu or **Start screen**, depending on your Windows operating system.
2. On the **Service/License File** tab, ensure that **Configuration using services** and Tekla Licensing Service are selected.
3. Go to the **Config Services** tab, and click **Browse** to locate the `lmgrd.exe` file.

By default, the file is installed in the `..\Tekla\License\Server` folder.

4. Click **Save Service**.
5. Go to the **Start/Stop/Reread** tab and click **Stop Server**.
6. Click **Start Server** to restart the server.

The changes are applied.



LMTOOLS does not show the licensing service status.

The status list on the **Server status** tab in **LMTOOLS** indicates that the license file cannot be found: "Error getting status: Cannot find license file. The license files (or license server system network addresses) attempted are listed below. Use LM_LICENSE_FILE to use a different license file, or contact your software provider for a license file".

Reason: You are trying to perform a status enquiry of a licensing service that is not running.

Solution: You need to start Tekla Licensing Service. Do the following:

1. Go to **Tekla Licensing** --> **LMTOOLS** through the **Start** menu or **Start screen**, depending on your Windows operating system.
2. On the **Service/License File** tab, ensure that **Configuration using services** and Tekla Licensing Service are selected.
3. Go to the **Start/Stop/Reread** tab and click **Start Server**.
4. Go to the **Server Status** tab and click **Perform Status Enquiry** again.

See also

[Install Tekla license server - manual installation \(page 48\)](#)

[Configure Tekla license server manually \(page 52\)](#)

[Problems in Tekla licensing: Error codes and their descriptions \(page 97\)](#)

Problems in starting Tekla Structures

 **Tekla Structures does not start. The following message is displayed: "Error when connecting to the license server. Contact your system administrator or try another server".**

Reason: You are not connected to the license server.

Solution: Check the following:

- Check that your network connection is working.
- Check that you have entered the license server name correctly.
For more information, see [Preconfigure license server settings for users \(page 69\)](#).
- Check that license information in **LMTOOLS** is correct. If not, reread the license file in **LMTOOLS** and try to start Tekla Structures again.
For more information about **LMTOOLS**, see LMTOOLS options and settings used in Tekla licensing.



Tekla Structures does not start. The following message is displayed: "License server system does not support this feature".

Reason: Your license server may not be up to date.

Solution: Update the status of your license server. Do the following:

1. Go to **Tekla Licensing** --> **LMTOOLS** through the **Start** menu or **Start screen**, depending on your Windows operating system. Start **LMTOOLS** using administrator rights.
2. On the **Service/License File** tab, ensure that **Configuration using services** and Tekla Licensing Service are selected.
3. On the **Start/Stop/Reread** tab, click **Stop Server** and wait a couple of seconds.
4. Click **Start Server**.
5. Start Tekla Structures.

If the problem still persists, contact your local Tekla Structures support. The support will need a copy of the following files: `tekla.lic`, `tekla.opt`, and `tekla_debug.log` files.



Tekla Structures does not start occasionally.

The following message is displayed: "Cannot connect to license server system. The license server manager (lmgrd) has not been started, the wrong port@host or license file is being used, or the port and hostname in the license file has been changed".

Reason: There may be communication problems between your license server and Tekla Structures client computers if the port of the license server is not defined.

Solution: Define the port for the license server. Do the following:

1. Go to **Tekla Licensing** --> **LMTOOLS** through the **Start** menu or **Start screen**, depending on your Windows operating system.
2. On the **Service/License File** tab, ensure that **Configuration using services** and Tekla Licensing Service are selected.
3. On the license server computer, define a free port for the license server in the `tekla.lic` file. For more information, see [Modify the license file tekla.lic manually \(page 51\)](#).
4. Go to the **Start/Stop/Reread** tab and stop the license server by clicking **Stop Server**.
5. Click **Start Server**.
6. Start Tekla Structures on a client computer.
7. In Tekla Structures, click **Tools** --> **Change License Server** . Define the port and hostname of the license server.
8. Close Tekla Structures.
9. Repeat steps 5 to 7 on all Tekla Structures client computers.

See also

[Preconfigure license server settings for users \(page 69\)](#)

[Problems in Tekla licensing: Error codes and their descriptions \(page 97\)](#)

Problems with options file tekla.opt



The tekla.opt file does not take effect.

Reason: The licensing service has not read the options file.

Solution: Do the following:

1. Go to **Tekla Licensing** --> **LMTOOLS** through the **Start** menu or **Start screen**, depending on your Windows operating system.
2. On the **Service/License File** tab, ensure that **Configuration using services** and Tekla Licensing Service are selected.
3. On the **Start/Stop/Reread** tab, click **ReRead License File**.
4. Browse to the `..\Tekla\License\Server` folder and open the `tekla_debug.log` file and the `tekla.opt` file with a text editor.

5. Check that the `tekla_debug.log` file contains the same keyword strings as the `tekla.opt` file.

If this does not help, please contact your local support.

```
C:\TeklaStructures\License\Server\tekla.opt - Notepad++
File Edit Search View Encoding Language Settings Macro Run Plugins Window ?
1 INCLUDE VIE-C USER paha

C:\TeklaStructures\License\Server\tekla_debug.log - Notepad++
File Edit Search View Encoding Language Settings Macro Run Plugins Window ?
1 20:49:14 (lmgrd) Started tekla (pid 1364)
2 20:49:14 (tekla) Flexnet Licensing version v11.4.100.0 build 50818_n3
3 20:49:14 (tekla) Using options file "C:\TeklaStructures\License\Server\tekla.opt"
4 20:49:44 (tekla) Server started on localhost for: TeklaServer
5 20:49:44 (tekla) EXTERNAL FILTERS ARE OFF
6 20:50:12 (lmgrd) tekla using TCP-port 1074
7 21:59:38 (tekla) TCP_NODELAY NOT enabled
8 22:05:30 (lmgrd) Rereading license file... Requested for paha02-paha
9 22:05:30 (tekla) Rereading license file...
10 22:05:30 (lmgrd) Done rereading
11 22:05:30 (lmgrd) ...Finished rereading
12 22:05:31 (tekla) Server started on localhost for: TeklaServer
13 22:05:31 (tekla) VIE-C
14 22:05:31 (tekla) Updating features TeklaServer
15 22:05:31 (tekla) Rereading options file...
16 22:05:31 (tekla) INCLUDE USER paha VIE-C
17 22:05:31 (tekla) ...Finished rereading
```

See also

[Modify on-premises license access rights \(tekla.opt\) \(page 74\)](#)

[Problems in Tekla licensing: Error codes and their descriptions \(page 97\)](#)

Problems in Tekla licensing: Error codes and their descriptions

Error 6

Problem: License library initialization failed with error: Activation Library Initialization error #6. Please, contact software vendor to resolve the problem.

Reason: Tekla license server installation folder contains `.dll` files that are from the previous Tekla license server version.

Solution: To resolve the problem, do the following:

1. Close Tekla License Administration Tool and stop the Tekla license server in **LMTOOLS** by clicking **Stop Server** on the **Start/Stop/Reread** tab.
2. Uninstall all existing Tekla license server installations.

3. If the Tekla license server installation folder contains any `.dll` files, remove the files manually.
4. Now you can install Tekla license server to the same folder where the uninstalled version was.

For more information about license server installation, see [Installing Tekla on-premises license server \(page 45\)](#).

NOTE Deactivation is not needed in this case. Licenses are kept safe in a specific Flexera Software location outside Tekla license server installation directory.

Error 20

Problem: Error 20: The licensing service is not installed.

Reason: The error occurs when you are starting Tekla License Administration Tool, or when you are trying to run `serveractutil.exe` command line tool.

Solution: If you selected the **Manual** option for Tekla Licensing Service installation then you need to manually install FLEXnet licensing service:

1. If you have some other FlexNet licensing service running on the server, stop it before entering the commands.
2. Go to the **Start** menu or **Start screen**, depending on your Windows operating system, and open **Command Prompt** as an administrator.
3. At the command prompt, type the following commands:

```
cd /D full_path_to_installation_directory
```

For example, if you install Tekla license server to the default folder, you need to enter `cd /D C:\Tekla\License\Server`.

```
installanchorservice.exe
```

Error 109

Problem: There are no activated licenses to return. Another program may have modified the activated licenses rights concurrently. (109) Unable to return as there is no licenses in Trusted Storage.

Reason: The trusted storage has been modified, probably by some other program.

Trust Status

 The red Restore (**R**) trust status of your license is not trusted. The license is broken, therefore it cannot be returned.

Solution: The license will become available on the server machine automatically when the borrow period ends.

Error 123 or error 50030

Problem: Message 1: Row n: An error occurred but FLEXnet Licensing did not return an error number. (123)

Message 2: Failed to load trusted storage or specified ASR. (50030)

Reason: These error messages indicate that the trusted storage cannot be loaded, and your trusted storage is corrupted.

Solution: Your licenses need to be replaced. Contact your local Tekla representative for a replacement along with some instructions.

Error 1316

Problem: License server installation fails.

The following message is displayed: "A network error occurred while attempting to read from the file C:\Documents and Settings\

Reason: You have an older version of the license server installed.

Solution: Uninstall the old version and then install the new version of the license server.

For more information about uninstalling the server, see Uninstall Tekla Structures.

Error 7109

Problem: License activation fails.

Reason 1: The emergency licenses are outdated.

Solution: Use a valid emergency license.

Reason 2: You tried to activate the entitlement for the online subscription in Tekla License Administration Tool.

Solution: Activate the online subscription in Tekla Online Admin Tool.

For more information, see [Manage Tekla Structures online licenses](#).

Error 7174

License activation fails, and the following message is displayed: "Unspecified FLEXnet Error with code 7174 Only deployed entitlement line item can be fulfilled."

Reason: You are trying to activate an obsolete license.

Solution: You should have received a new entitlement certificate from your local Tekla representative. Try the activation again with the new entitlement certificate, and move the old obsolete entitlement certificate in an archive folder.

For more information, see [Activate on-premises licenses \(page 65\)](#).

Error 7284

Problem: Unspecified FLEXnet Error with code 7284. Cannot perform support actions on inactive fulfillment record

FID_XXXXXXXXXXXXXXXXXXXX.

Reason: Trusted Storage has been restored from an old backup copy. The license with fulfillment ID FID_XXXXXXXXXXXXXXXXXXXX has been deactivated already.

Solution: You need to restore trusted storage files from the most recent backup copy and then repair licenses if needed.

For more information about repairing licenses, see [Repair an on-premises license \(page 80\)](#).

Error 7288 and error 111

Message 1: The activation of the fulfillment is denied by the activation policy because fulfill count exceeded the available seat count.

Message 2: The activation of the fulfillment is denied by the activation policy because number of copies left is zero.

Reason 1: You may be trying to activate some licenses that have been activated before on another server/computer.

Solution: Deactivate the licenses from the other computer, and then activate the licenses on the new server/computer.

Reason 2: You may be trying to activate a renewed temporary license or permanent licenses without deactivating the previous linked activated licenses.

Solution: Deactivate the existing temporary licenses first and then activate the succeeding linked licenses.

For more information about deactivating licenses, see [Deactivate on-premises licenses \(page 70\)](#).

Error 7343

Problem: Unspecified FLEXnet Error with code 7343 Entitlement line item has expired on <date> <time>.

Reason: License has expired. It is not possible to activate or repair expired licenses.

Error 7466

Problem: License deactivation fails, and the following message is displayed: "The return of the fulfillment is denied by the return policy because max return exceeded".

Reason: You have deactivated the license too many times in a 30 days period.

Solution: You can deactivate the license again when 30 days have passed since the first deactivation of the license in the past 30 days. The number of

deactivations of a license within a given time period is limited due to technical and security reasons.

Error 7581

Problem: Unspecified FLEXnet Error with code 7581. Online Return/Repair Request for the activationId XXXX-XXXX-XXXX-XXXX-XXXX-XX is not originated from the original client machine.

Reason and solution: The computer is not the same where the licenses were originally activated, and you need to return/repair licenses from the original computer. Another reason might be that the computer has changed so much that activation server at Trimble Solutions no longer recognizes it as the same one, in which case you need to replace your licenses.

For more information about returning and repairing licenses, see [Returning a borrowed license \(page 110\)](#) and [Repair an on-premises license \(page 80\)](#).

Error 9999

Problem 1: Cannot connect to the license server at Trimble Solutions

Reason 1: Licensing server at Trimble Solutions is down.

Solution: Wait for a while and retry.

Problem 2: Difficulties when trying to activate the license

Reason 2: The problem is related to long activation ID chains, which are typical for old licenses ordered for a long time ago for the first time. Typically, the license has been renewed for years without the need of a replacement of the license. Activation IDs may have been linked for a long time, which might cause a timeout when trying to activate the newest version of the license.

Solution: Your licenses need to be replaced. Contact your local Tekla representative for a replacement along with some instructions.

Error 50005

Problem: Error (5005) License Activation failed - Initialization of API Failed.

The activated licenses are not visible and it is not possible to activate new licenses.

Reason: The installation package has failed to initialize or register some of the software components.

Solution: Do the following:

1. Log in with administrator's rights.
2. Close Tekla License Administration Tool.
3. Stop Tekla license server and other license servers on the same computer on the **LMTOOLS** --> **Start/Stop/Reread** tab.
4. Go to `..\Tekla\License\Server` folder.

5. Double-click `installanchorservice.exe`.
6. Start Tekla license server and other license servers on the same computer on the **LMTOOLS** --> **Start/Stop/Reread** tab.
7. Open Tekla License Administration Tool. The message should not be displayed anymore.

Error 50018

Problem: License borrowing fails.

Reason: Wrong product ID file is used.

Solution: Do one of the following:

- Export a product ID file in Tekla License Administration Tool and use the file for borrowing.

Error 50033

Problem: License borrowing fails.

Reason 1: Your license server may not have up-to-date license information.

Solution: In **LMTOOLS**, stop and then restart the server.

Reason 2: The `INCLUDE` keyword in the options file prevents the borrowing of the configuration.

Solution: You need to add a dummy user "ACTIVATED LICENSE(S)" into the group of the included users to enable the borrowing. Do the following:

1. Open `tekla.opt` using a text editor.
2. Add "ACTIVATED LICENSE(S)" in the group of the included users, for example:

```
GROUP steel "ACTIVATED LICENSE(S)" user1 user2 user3
user4

INCLUDE STD-C GROUP steel
```

3. Save the changes you made in `tekla.opt`.
4. In **LMTOOLS**, reread the license file or stop the server and then start the server.

Error 50035

Problem: License borrowing fails.

Reason: The user tried to borrow a license that is not activated on the license server. For example, the user tried to borrow a version 20 license and there are only version 21 licenses activated on the server.

Solution: Do the following:

- Check that the product ID file is up to date. If not, export a new product ID file in Tekla License Administration Tool (**File** --> **Export**) and send this file to the user for borrowing. Then ask the user to save the new product ID

file, open the Tekla License Borrow Tool, click **Open** and browse for the new `.tpi` file and try borrowing again.

- Check that your license information is up to date in **LMTOOLS**. If not, reread the license file.

Error 50036

Problem: License borrowing fails.

Reason: You are not allowed to borrow the license.

Solution: Do one of the following:

- The options file (`tekla.opt`) needs to be modified so that the borrowing of the license is allowed. For more information, see [Modify on-premises license access rights \(tekla.opt\) \(page 74\)](#).
- Borrow another license.

Error 50037

Problem: License returning fails.

Reason: You tried to return the license to a different license server than it was borrowed from.

Solution: You need to return the license to the same license server that it was borrowed from. Do the following:

1. Go to **Tekla License Borrow** --> **Tekla License Borrow Tool** through the **Start** menu or **Start screen**, depending on your Windows operating system.
2. Click **Setup** and enter the name of the license server where you originally borrowed the license from and click **OK**.
3. Select the **Return** check box in the **Borrowed Licenses** area to select the license for returning.
4. Click the **Return** button to return the license.

After successful returning of licenses, the **Borrowed Licenses** area is updated.

Error 50040 or error 50041

Error 50040 or error 50041, problem 1: License activation, deactivation or repairing fails

Reason: Your license server was not able to connect to activation server at Trimble Solutions correctly. Usually this is a temporary problem in online activation.

Solution: Do the following:

- Check that your Internet connection is working. An Internet connection is needed during license activation and deactivation. A low connection speed may also cause errors.

- Close Tekla License Administration Tool and try to activate the license a while later.
- Try to activate another license.
- Your firewall may block the activation communication. Check your firewall settings. For more information, see [Allowing Tekla on-premises license server to operate through Windows Firewall \(page 54\)](#).
- Check that you have the latest Tekla license server version.
- This error could be caused by unfinalized Windows updates on the server computer. Reboot the server and try again.
- Your Windows login user name may contain special characters. Try to log in with another user name, for example, administrator.
- Check that your Internet connection is working.
- Contact your local Tekla Structures support and ask for a manual activation.

Error 50040 or error 50041, problem 2: License borrowing fails.

Reason: You are not connected to the license server.

Solution: Do the following:

- Check that your network connection is working.
- Start Tekla License Borrow Tool and check that you have entered the correct license server information.

See also

[View and diagnose errors in Tekla Structures license activation, deactivation and borrowing \(page 82\)](#)

[Problems in Tekla license activation \(page 86\)](#)

[Problems in Tekla license borrowing \(page 90\)](#)

[Problems in Tekla license deactivation \(page 90\)](#)

3.8 Set up on-premises license borrowing for offline use

Users who want to work in a location that does not have a reliable connection to the on-premises license server can borrow an activated license from the Tekla license server before leaving the office. The user receives a temporary local license file valid for a set time period.

The information on this page is not valid for online subscriptions.

Users can borrow Tekla Structures on-premises licenses for offline use in Tekla License Borrow Tool. Users need to have a network connection to the license server to borrow and return a license.

Borrowed licenses are reserved for the duration of the borrowing even when they are not in use, so the borrowed license is not available for other users.

Configuration files

A product ID (.tpi) file is needed for borrowing licenses. If you use the licensing options file (tekla.opt) for managing license access rights, you must always provide a customized product ID file for users. The default file that lists all configurations will technically work in other cases, but administrators should still provide a customized product ID file. The customized file makes it easier for the users to select a license, because it includes just those licenses that you have actually activated on the server. For more information, see [Provide offline users with a customized product ID file \(page 106\)](#).

You can define which licenses are available for which users in the licensing options file (tekla.opt) on the license server. For more information, see [Modify on-premises license access rights \(tekla.opt\) \(page 74\)](#).

How on-premises license borrowing works

License borrowing reserves and releases the on-premises licenses like this:

- The maximum license borrow period is one month. The user defines the borrow expiration date when borrowing the license. The borrowed licenses are unavailable to other users until they are returned or the license borrow period ends.
- The user can return a license before the license borrow period is over through the license borrow tool on the borrowing computer. Make sure your users return all borrowed licenses before a major operating system upgrade, reinstallation or major hardware changes on their computer.
- Borrowed licenses must be returned before you deactivate those licenses on the license server, for example, to upgrade the licenses to a new version or to move the license server to new hardware. You can see who has borrowed which licenses by enquiring the license status in the LMTTOOLS application on the license server.

NOTE If you do not follow the guidelines above, all users may lose the use of the borrowed licenses until the end of the license borrowing period, including the users who originally borrowed the licenses.

1. Install the Tekla License Borrow Tool on the users' computers with customized product ID file(s).

2. To borrow a license, users must open the Tekla License Borrow Tool installed on their computer when they are still online and can connect to the Tekla license server.

The version of Tekla License Borrow Tool should be the same as the version of Tekla license server.

3. After borrowing a license, users can go offline and freely work with, close and reopen Tekla Structures within the license borrow period.
4. When the users are back online, they should return the borrowed licenses to the license server.

If a user does not return the license, it becomes available for other users on the license server after the license borrow time is over. However, the license is still listed in the license borrow tool for the user until the user returns it.

For detailed instructions, see [Set up Tekla License Borrow Tool for Tekla Structures offline use \(page 107\)](#).

For end-user instructions, see [Borrow a license from on-premises license server \(page 108\)](#) and [Return a borrowed on-premises license \(page 110\)](#).

See also

[Problems in Tekla license borrowing \(page 90\)](#)

[Problems in Tekla licensing: Error codes and their descriptions \(page 97\)](#)

Provide offline users with a customized product ID file

Tekla License Borrow Tool for on-premises licenses needs the activation IDs of the licenses during borrowing. When you export a product ID file (.tpi) in Tekla License Administration Tool, the activation IDs of the activated licenses are written in the file. Then you can send the file to offline users.

The information on this page is not valid for online subscriptions.

When you install Tekla License Borrow Tool, the `standard.tpi` file is automatically installed in the `..\Tekla\License\Borrow` folder. This default product ID file lists all Tekla Structures configurations and their product IDs. However, users can only borrow the licenses that are activated on the license server.

You can create a customized product ID file that only lists the activation IDs of the activated licenses available for borrowing. You need to export the product ID file on the license server computer using Tekla License Administration Tool and save the file on the computers of the users who borrow licenses. The activation IDs are encrypted.

WARNING Product ID files are not updated automatically. If you deactivate borrowable licenses or activate new licenses for borrowing, you

need to export a new product ID file and send it to Tekla Structures offline users who borrow licenses.

To export the product ID file on the Tekla license server computer:

1. Go to **Tekla Licensing** --> **Tekla License Administration Tool** through the **Start** menu or **Start screen**, depending on your Windows operating system.
2. Click **Export**.
3. In the **Save Product ID file As** dialog box, enter the name of the product ID file or keep the default file name, select a folder where you want to save the file and click **Save**.
4. Send the product ID file to the Tekla Structures users who need to borrow licenses and inform the users about the usage of the file.

If the name of the file is `standard.tpi` and the file is saved in the `..\Tekla\License\Borrow` folder on the user's computer, the file is opened automatically when the user starts Tekla License Borrow Tool.

See also

[Set up Tekla License Borrow Tool for Tekla Structures offline use \(page 107\)](#)

Set up Tekla License Borrow Tool for Tekla Structures offline use

You can use Tekla Structures on-premises licenses offline or off-site by borrowing Tekla licenses with Tekla License Borrow Tool.

The information on this page is not valid for online subscriptions.

Before you start, download and install the latest Tekla License Borrow Tool from the [Tekla Downloads](#) product download page.

You can use the same Tekla License Borrow Tool for borrowing licenses for different Tekla Structures versions. The version of Tekla License Borrow Tool should be the same as the version of Tekla license server.

To set up Tekla License Borrow Tool for Tekla Structures offline use:

1. Go to **Tekla License Borrow** --> **Tekla License Borrow Tool** through the **Start** menu or **Start screen**, depending on your Windows operating system.
2. In the **Setup** dialog box, enter the port number and the hostname (computer name) of the license server in the **Server** box in the format `port@hostname`, for example, `27007@server_hostname`.
3. Still in the **Setup** dialog box, click **Browse** and select the product ID file.
4. Click **OK**.

The **Products** area in the Tekla License Borrow Tool is updated.

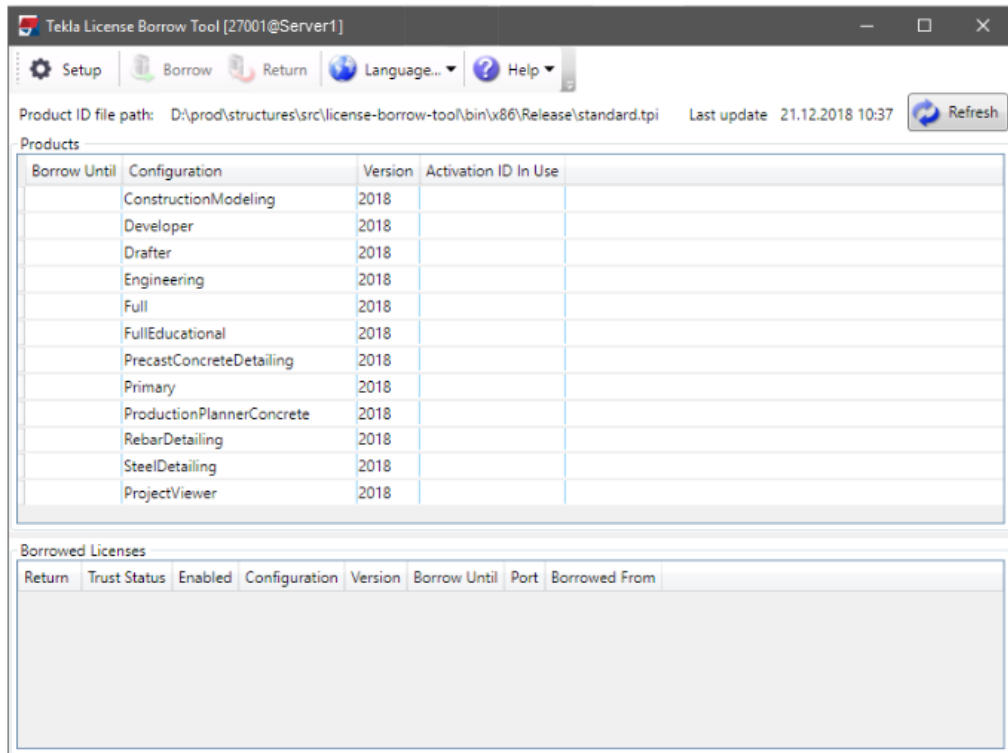

5. In the Tekla License Borrow Tool dialog box, click **Language** and change the language of the Tekla License Borrow Tool user interface, if necessary.

NOTE When you start Tekla Structures, and if Tekla Structures does not start with the borrowed license, enter an asterisk (*) in the server box of the licensing dialog box. This will force Tekla Structures to search for all possible locations for the license. This may take a while.

See also

[Problems in Tekla license borrowing \(page 90\)](#)

Borrow a license from on-premises license server

In Tekla License Borrow Tool, you can borrow Tekla Structures on-premises licenses from Tekla license server when you want to work offline. Borrow the license on the same computer that you will use for offline work.

The information on this page is not valid for online subscriptions.

Before you can borrow an on-premises license, you need to install Tekla License Borrow Tool, connect the computer with Tekla Structures to the license server and open the product ID file.

For more information about the prerequisites, see [Set up Tekla License Borrow Tool for Tekla Structures offline use \(page 107\)](#).

To borrow a license:

1. Close Tekla Structures.
2. Go to **Tekla License Borrow** --> **Tekla License Borrow Tool** through the **Start** menu or **Start screen**, depending on your Windows operating system.
3. Click the **Setup** button at the top of the dialog box.
4. In the **Setup** dialog box, enter the port number and the hostname (computer name) of the license server in the **Server** box in the format `port@hostname`, for example, `27007@server_hostname`.

You need to use exactly the same port and host name as when starting Tekla Structures.

5. Still in the **Setup** dialog box, click **Browse** and select the product ID file.
6. Click **OK**.
7. In the **Products** area, click the **Borrow Until** box and select the expiration date for the borrowing period from the calendar.

The maximum borrowing period is one month. The exact maximum borrow period varies between 29 to 32 days depending on the borrowing date.

Products						
Borrow Until	Configuration	Version	Activation ID In Use	Start Date	Expiration Date	
15.11.2018	SteelDetailing	2018		1.11.2018	30.11.2018	

8. Click the **Borrow** button to borrow the license.

The borrowing progress is displayed in the **Borrowing License(s)** dialog box. After successful borrowing, the **Borrowed Licenses** area shows the borrowed license.

Borrowed Licenses						
Return	Trust Status	Enabled	Configuration	Version	Borrow Until	Borrowed From
<input type="checkbox"/>			SteelDetailing	2018	15.11.2018	Z-USERX

9. To ensure that the borrowing succeeded, disconnect your computer from the license server and start Tekla Structures with the borrowed license.

See also

[Problems in Tekla license borrowing \(page 90\)](#)

[Problems in Tekla licensing: Error codes and their descriptions \(page 97\)](#)

[View and diagnose errors in Tekla Structures license activation, deactivation and borrowing \(page 82\)](#)

[Set up on-premises license borrowing for offline use \(page 104\)](#)

Return a borrowed on-premises license

You can return a borrowed Tekla Structures on-premises license back to the Tekla license server before the expiration date.

The information on this page is not valid for online subscriptions.

A borrowed license is automatically available on the license server on the day following the expiration date.

However, the **Borrowed Licenses** area in Tekla License Borrow Tool is not automatically updated. The license should be returned to the server that has the same name as the name of the server from which the license was borrowed. We recommend that you always return the expired licenses when you want to stop borrowing a license.

To return a borrowed Tekla license:

1. Ensure that you are connected to the license server.
2. Close Tekla Structures.
3. Go to **Tekla License Borrow** --> **Tekla License Borrow Tool** through the **Start** menu or **Start screen**, depending on your Windows operating system.
4. Select the **Return** check box in the **Borrowed Licenses** area to select the license for returning.
5. Click the **Return** button to return the license.

After successful returning of licenses, the **Borrowed Licenses** area is updated.

See also

[Problems in Tekla licensing: Error codes and their descriptions \(page 97\)](#)

4 Implementation guide for administrators

Tekla Structures administrator is the person responsible for ensuring that the company standards are used and set up in Tekla Structures. The following sections explain how you can customize Tekla Structures.

4.1 Customizing Tekla Structures

Each new version of Tekla Structures introduces new features and functionalities to improve the overall process used for completing a project. Tekla Structures has multiple environments to suit the needs and requirements of specific markets. Many features are localized in each Tekla Structures version. Most of the changes in versions are focused on making the default saved attributes more consistent, organized, simplified, and practical.

Your local technical team is dedicated to improving your knowledge and experience of each new version. The team aims at enhancing your user experience of Tekla Structures by performing tasks that have been identified as essential by the existing users, new users, and potential users.

Before you start customizing Tekla Structures to suit the needs of your company and your projects, collect the needed information, such as drawing standards, used profiles, grades and materials, company logos, and naming conventions.

The overall localization of Tekla Structures can be divided into four different layers:

- Tekla Structures environment
- Company-level settings
- Project-level settings
- Multi-user settings

The three last ones are mainly managed by company administrators.

Setting up the standard that a company uses, and the standards that a specific project needs will make the designing process much more efficient because the end user can concentrate on the design process.

Tekla Warehouse

[Tekla Warehouse](#) has a lot of additional content, such as application tools and environment content. You can download Tekla Warehouse offline content that includes the catalog content of environments, such as profiles, bolts, materials, and reinforcement.

The offline catalog content is under **Tekla Structures collections** in Tekla Warehouse. The content is in .tsep packages that are installed when opening Tekla Structures.

You can also create a local collection for your company, and share it for your organization in your internal network. You can manage the access rights on the folder and collection level in the `collections.json` file on each user's computer. Copy the file to the same location on each user's computer. The file is located in `C:\Users\Public\Public Documents\Trimble\Tekla Warehouse\collections.json`.

The image below shows an example of the collection paths with four Tekla Structures collections:

```
{
  "collections":
  [
    "\\\Server1\\Tekla Warehouse\\OfflineContent\\austria",
    "\\\Server1\\Tekla Warehouse\\OfflineContent\\brazil",
    "\\\Server1\\Tekla Warehouse\\OfflineContent\\china",
    "\\\Server1\\Tekla Warehouse\\OfflineContent\\czech",
  ]
}
```

In Tekla Warehouse the collections are found after mapping under **My collections** --> **Local and network collections** .

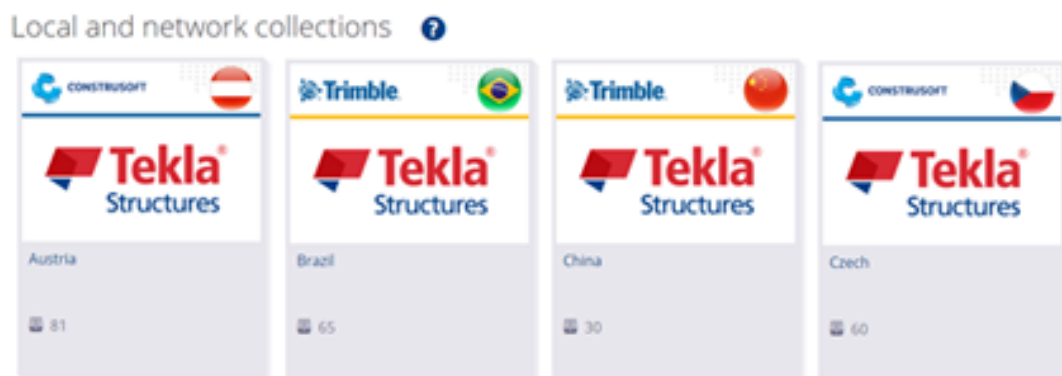

4.2 Overview of environments, roles and licenses

Tekla Structures is one product that has many different configurations. The licenses you have determine which configurations you can use.

A Tekla Structures **environment** is set up for the materials, grades, profiles, drawing settings, component settings, .ini file settings that are used in a specific market. There are over 30 different environments in Tekla Structures. By choosing a specific environment when starting Tekla Structures you will get the settings for that market. You can install several environments, and add missing environments later.

The blank project listed in the environments is an empty platform for your own environment or project settings. It includes standard parametric profiles, undefined bolt, material and rebar grades, basic drawing layouts and so on, which you can complement from your own firm or project folders and Tekla Warehouse.

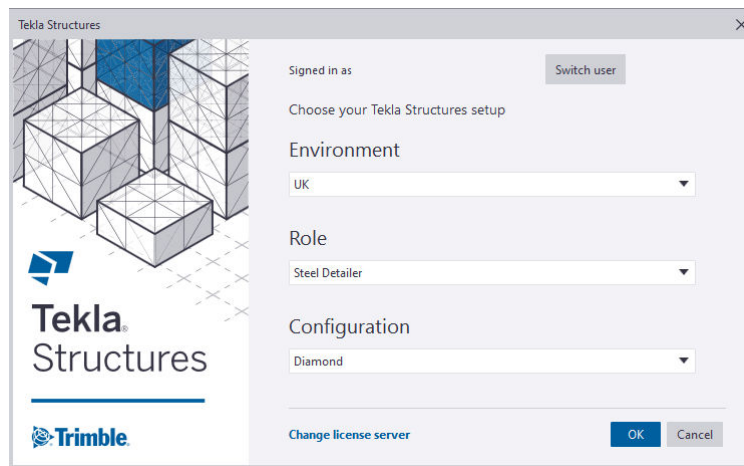

Some environments give you the opportunity to select a **role** when logging in. The role is independent from the licenses that are used. The purpose of the roles is to make the user interface and settings clearer, easier and faster for the user's tasks.

In practice, this means that settings, filters, reports and the user interface is set up for the role the user has. For example, preloaded settings in object properties that are not relevant for the role are not shown, making the list of options shorter and clearer.

Role selection is primarily meant to be configured by Trimble and reseller localization personnel, and be part of the Tekla Structures installation package. However, advanced users and Tekla Structures system administrators can also create their own roles inside their company organization. Additional content is available in the Tekla Warehouse offline and online collections. Note that you need to have a Trimble Identity for downloading or installing from the online collections. For more information, see [Trimble Identity for Tekla Online services](#).

Using roles for ribbon selection with the subscription license configurations

Note that the ribbon selection with the subscription license configurations is primarily meant to be configured by Trimble and reseller localization personnel.

With the subscription licenses, roles can be used for controlling which ribbon is shown for a certain role. The [role-specific .ini files in the environments \(page 277\)](#), for example, `role_Steel_Detailer.ini` or `role_Rebar_Detailer.ini`, contain advanced options `XS_RIBBON_CONFIGURATION_DIAMOND`, `XS_RIBBON_CONFIGURATION_GRAPHITE`, and `XS_RIBBON_CONFIGURATION_CARBON`. The advanced options define the ribbons for the specific role.

The advanced options need to point the [configuration identifiers \(page 134\)](#) of the ribbon files, either to the configuration identifiers of the legacy on-premises license configurations, or to the configuration identifiers of the online license configurations. It is not possible to make up new configuration identifiers.

If the advanced options are not set, Tekla Structures uses the default ribbons for each subscription license configuration.

Example:

For the users who select the **Precast Concrete Detailing** role, you could have the following settings in the `role_Precast_Detailer.ini` file:

```
set XS_RIBBON_CONFIGURATION_CARBON=albl_up_Carbon
set XS_RIBBON_CONFIGURATION_GRAPHITE=albl_up_PC_Detailing
set XS_RIBBON_CONFIGURATION_DIAMOND=albl_up_PC_Detailing
```

For more examples, see your `role_<role>.ini` files used in your environment.

TIP Administrators who have own environment and roles in use: for the own role, such as, for timber detailer, you can create a folder for the ribbon files in `..\<environment>\Timber\Detailing\Ribbons`, for example. Place the customized ribbon files in the folder, and include the folder in the `XS_SYSTEM` path definition for that specific role.

4.3 Folder structure

Tekla Structures software and environments are separated into different locations due to the requirements for Windows certification. By default, the files are installed in the following folders:

- Software is installed under the `\Program Files\Tekla Structures` folder.

- Environments and extensions are installed under the `\ProgramData\Trimble\Tekla Structures` folder.
- User settings are installed under the `\Users\<username>\AppData\Local\Trimble\Tekla Structures` folder.

4.4 Project and firm folders

Project and firm folders are meant for storing the customized files. For any company, we strongly recommend setting up firm and/or project folders on a shared file server accessible to all users. If multiple teams on different sites are working on the same project, you can set up a project or firm folder in a folder in a Trimble Connect project.

Having the hierarchy of project and firm folders will make it much easier to update company settings, ensure that everyone uses the same settings in a project, and upgrade to a newer version of Tekla Structures.

All the settings that are used on the company level (for example, company logo and drawing standards) should be stored in a firm folder, and all the settings used on a specific project should be stored in the corresponding project folder. Property files are always saved in the `\attributes` folder under the current model folder, like, `\TeklaStructuresModels\<my_building>\attributes`. These files should then be copied to the project or firm folder, or to user-defined sub-folders under the project or firm folder.

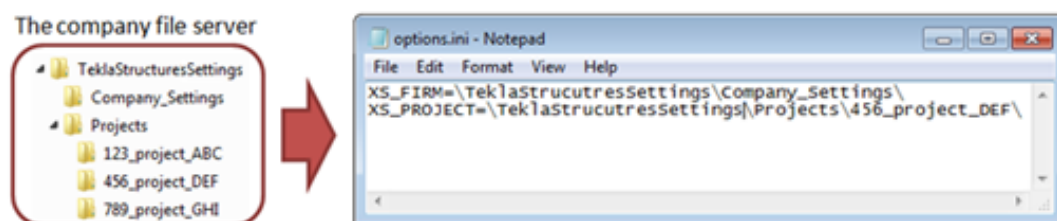

To use the saved settings in a firm and a project folder, set the path to the folder by using the `XS_PROJECT` and `XS_FIRM` advanced options. These advanced options should be put in the initialization, `.ini`, files. You can have several different `.ini` files. You can define in the Tekla Structures shortcut which `.ini` files to run and which settings to apply.

One of the most important advantages of using firm and project folders is that Tekla Structures does not replace files in the project and firm folders when you install a new version. This means that you retain your customized files without having to cut and paste, or export and import from previous versions. This makes upgrading to a newer version of Tekla Structures easier. When you store files in one place, it is also easier to update the settings and ensure that everyone in a project uses the same settings.

Example:

In the current project, *123_project_ABC*, you have set up the properties for the concrete column, and saved them as *column_ABC*. To make these saved settings available for everyone working in the *123_project_ABC* project, copy *column_ABC.ccl* from the `\attributes` folder under the model folder to the `\123_project_ABC` project folder or on your file server, or to a user-defined sub-folder under the `\123_project_ABC` project folder. Ensure that everyone in the project has the correct path for the `XS_PROJECT` advanced option in the `.ini` file.

For more information, see [Create project and firm folders \(page 266\)](#) and [Files and folders in Tekla Structures \(page 265\)](#).

4.5 Folder search order

When you open a model, Tekla Structures searches for the associated files in specific folders in a set order. It is important that you place the files in the correct folders. Once Tekla Structures finds the associated files, it stops searching. This means that the files that have the same name but are located lower down the search order are ignored.

The basic folder search order is the following:

Folder	Defined by
Model folder	Currently open model
Project	<code>XS_PROJECT</code>
Firm	<code>XS_FIRM</code>
System	<code>XS_SYSTEM</code>

You can specify more than one system folder, and this way define specific settings for each role. Use the role options defined in the `env_<environment>.ini` to point to the roles when specifying the system folders in the `XS_SYSTEM` advanced option. Enter the options pointing to the roles and separate them by semicolons, for example: `set XS_SYSTEM=%XS_STEEL%;%XS_ENGINEERING%;%XS_CONTRACTOR%;%XS_GENERAL%;%XSDATADIR%\environments\common\system\`

There are some exceptions to this search order. The exceptions are listed in [Folder search order \(page 361\)](#).

NOTE Do not store customized files in the system folder. Tekla Structures replaces these files when you install a new version.

4.6 Initialization files

[Initialization files \(page 271\)](#) (.ini) are used for launching Tekla Structures. They can contain many advanced options that you can use to configure Tekla Structures for different standards and your own style of working. Tekla Structures automatically creates the necessary .ini files during installation. The number of .ini files it creates depends on how many country-specific environments you choose to install.

Why are .ini files needed?

There are numerous settings to be made when Tekla Structures starts. Advanced options are used to determine the appearance and the behavior of Tekla Structures, for example, the language used, behavior of part marks on drawings, and the location of your model folder. Advanced options are set through the .ini files. The different .ini files and what they do, and how they are related to each other are described below.

Different types of .ini files

The [default reading order \(page 271\)](#) of the .ini files is as shown in the image below:

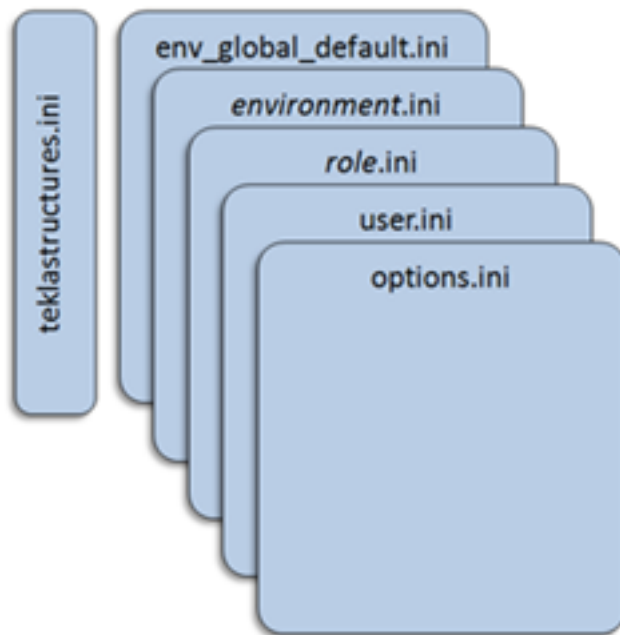

1. `teklastructures.ini`

Initializes the settings needed for Tekla Structures to run.

The `teklastructures.ini` file in the `\bin` folder starts Tekla Structures. We recommend that you do not make any changes to this file.

2. `env_global_default.ini`

Sets the global default settings.

The `env_<your_environment>.ini` file is located in the `\Environments` subfolder and it contains all the environment-specific settings. These files are set by your area office or reseller.

3. `environment.ini`

Sets the environment-specific settings.

You can define specific settings for roles in your environment and store these settings in role-specific folders. Organizing the folder structure based on roles is useful for keeping the role content up to date. Note that the folder structure and content may vary depending on the environment.

In the `env_<environment>.ini` file, each role has an option where you can add the paths that point to the folders in which you have stored the role settings. For example, `XS_STEEL` (`\Steel`), `XS_CONCRETE` (`\Concrete`), `XS_ENGINEERING` (`\Engineering`) and `XS_PRECAST` (`\Precast`) each point to the folders that contain settings specific to that role. An example for steel role could be as follows:

```
set XS_STEEL=%XSDATADIR%\environments\Steel\master_drawings\;%XSDATADIR%\environments\Steel\model_filters\;%XSDATADIR%\environments\Steel\model_settings\
```

`XS_GENERAL` points to the `\General` folder that has content common for all roles and settings that are specific to modeling and drawings, for example.

When defining role settings in `XS_SYSTEM`, you use the role options defined in the `env_<environment>.ini` to point to the role-specific settings. Note that you do not need to add the folder paths in `XS_SYSTEM` as they are defined in the `env_<environment>.ini`.

4. `role.ini`

Sets the settings defined for a role.

The `role_<role>.ini` file is located in the `\Environments` subfolder and it contains the settings specific for a chosen role. For example, the `role_Engineer.ini` file in the `\Environments\uk` folder contains all the settings for the Engineering role in the UK environment.

5. `user.ini`

Sets the settings specified by the user.

The `user.ini` file contains your personal settings. The advanced options in `user.ini` override those in other `.ini` files. For example, if you have set the same advanced option in an `.ini` file, in a file in the environments subfolder and the `user.ini` file, Tekla Structures uses the value in the `user.ini` file. The `user.ini` is located in the `C:\Users\<user_name>`

```
\AppData\Local\Trimble\Tekla Structures\<>version>
\UserSettings folder.
```

6. options.ini

Sets the settings specified for the company/project/model.

If there are several settings for the same advanced option, the later setting in the reading order overrules the previous one. This means that the settings in `user.ini` overrule the settings in `env_global_default.ini`, and the settings in `user.in` can be overruled by the settings in `options.ini`.

The `lang_enu.ini` is the initialization file for the English language settings. The file is located with the other installed languages in the `\Tekla Structures\<>version>\bin` folder.

We recommend that you make all your customizations in the `options.ini` file under the model folder, or in the `user.ini` file. This way the customizations are kept when you install the next version of Tekla Structures.

4.7 Setting advanced options in .ini files

Tekla Structures contains three kinds of advanced options: user-specific advanced options, system-specific advanced options, and model-specific advanced options.

NOTE Changing an advanced option value in `.ini` files located outside the model folder does not affect the existing models. You can only update the advanced options in the **Advanced options** dialog box or in the `options.ini` file located in the model folder, not from an `options.ini` file located in folders defined for the `XS_FIRM` or `XS_PROJECT` advanced option. The `.ini` files are also read when you open an existing model, but only new advanced options that do not exist in `options_model.db` or `options_drawings.db` are inserted, for example, such options that are not yet in the **Advanced Options** dialog box, but have been added in the software.

User-specific advanced options set your personal preferences, for example the appearance of the Tekla Structures window. Tekla Structures saves user-specific advanced option settings in the `options_<your_username>.ini` file, located in the `C:\Users\<user_name>\AppData\Local\Trimble\Tekla Structures\<>version>\UserSettings` folder.

The `options.ini` file contains the settings for **model-specific advanced options**. It is located in the current model folder. To share your settings with other people, copy the `options.ini` file to the system, project or firm folder.

The **system-specific advanced options** are stored in all other `.ini` files.

Setting advanced options

There are two methods for setting advanced options:

- The advanced options are grouped in different categories according to their usage in the **Advanced Options** dialog box. To access the dialog box, click **File** --> **Settings** --> **Advanced options**. See more in [Advanced options reference](#).
- The `.ini` files are plain text files that can be edited with a text editor, for example Notepad. The settings will then be saved in the `options.ini` file under the model folder for the model that you have open. The settings can then easily be copy-pasted into another `.ini` file. See more in [File storing options and advanced options \(page 279\)](#).

We recommend that you only use one of these methods to set advanced options. The settings in the **Advanced Options** dialog box override those in the `.ini` files. Some advanced options need a Tekla Structures restart to activate the new setting.

To set an advanced option in the `user.ini` file:

1. Locate the `user.ini` file in the `C:\Users\\AppData\Local\Trimble\Tekla Structures\\UserSettings` folder.
2. Select and right-click the `user.ini` file in Windows Explorer and click **Open with**. You can open the file in any standard text editor.
3. Check that the advanced option is set to the value you want. If it is, you can stop here.
4. To change or add the advanced option, on a new line, type `set`, add a space and the name of the advanced option followed by its value in a single line.

Tekla Structures only reads lines in the initialization file that start with `set`, for example, `set %XS_DIR%=C:\TeklaStructures\2019 .`

5. Save the `user.ini` file.

4.8 Creating shortcuts

To use the correct `.ini` files for a specific project, the easiest way is to create a shortcut for the project on the desktop. Shortcuts are used to start `teklastructures.exe` with the defined initializations.

1. Make a copy of the default shortcut: In the Windows **Start** menu or **Start screen**, find **Tekla Structures <version>**, then right-click the Tekla Structures <version>.
2. Select **Copy** from the pop-up menu.
3. Paste the shortcut to your desktop.
4. Select the shortcut and right-click.
5. Select **Properties** from the pop-up menu.

6. Modify the **Target** of the shortcut by adding the required project initializations to it.

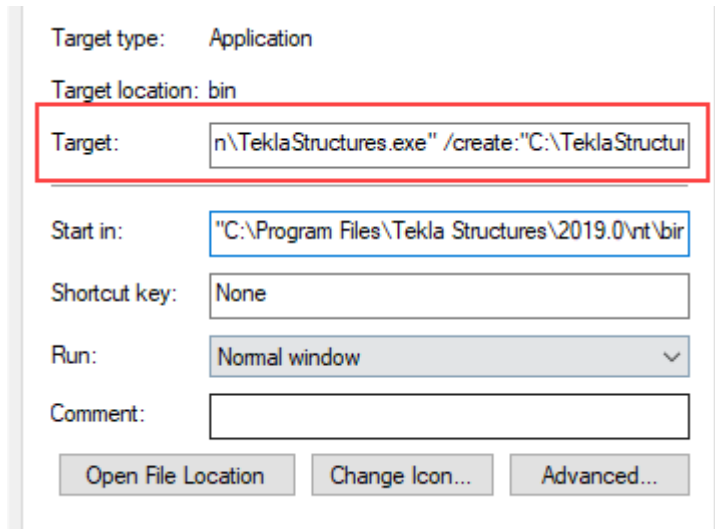

For example, you can use the following parameters in shortcuts:

- `-i InitializationFile`: Initialization file to be read during startup, for example: `-i \\MyServer\MyProject\Project1.ini`. You can repeat this parameter as many times as you need.
- `ModelToBeOpened`: Full path to the model to be opened automatically.
- `/create:ModelToBeCreated`: Full path to model to be created automatically.

`.ini` files tell where things can be found and in which order, depending on the folder structure that the company has set up. See more in [Create start-up shortcuts with customized initializations \(page 21\)](#).

4.9 Bypassing the login screen

You can bypass the login screen by using a separate `.ini` file where you set the following advanced options:

- `XS_LICENSE_SERVER_HOST` to set the on-premises license server address. To use online licensing, set the value to `https`.
- `XS_DEFAULT_LICENSE` to set the default license for a user role.
- `XS_DEFAULT_ENVIRONMENT` points to the environment-specific `.ini` file, for example `%XSDATADIR%\Environments\uk\env_UK.ini`
- `XS_DEFAULT_ROLE` points to the role-specific `.ini` file, for example `%XSDATADIR%\Environments\uk\role_Engineer.ini`

Define the startup shortcut using the parameter `-I` (capital i), for example, `-I %XSDATADIR%\Environments\uk\Bypass.ini`. When you do this, an additional initialization file is read BEFORE the environment `.ini`.

The content of such a file could be, for example:

```
set XS_LICENSE_SERVER_HOST=https
set XS_DEFAULT_LICENSE=DIAMOND
set XS_DEFAULT_ENVIRONMENT=%XSDATADIR%\Environments\uk\env_UK.ini
set XS_DEFAULT_ROLE=%XSDATADIR%\Environments\uk\role_Engineer.ini
```

See more in [Create start-up shortcuts with customized initializations \(page 21\)](#).

4.10 User-defined attributes

User-defined attributes are attributes set to an object in a model or a drawing. These user-defined attributes can be used for many purposes, such as in filters, drawings, reports, export, import, fabrication, erection, and revision handling.

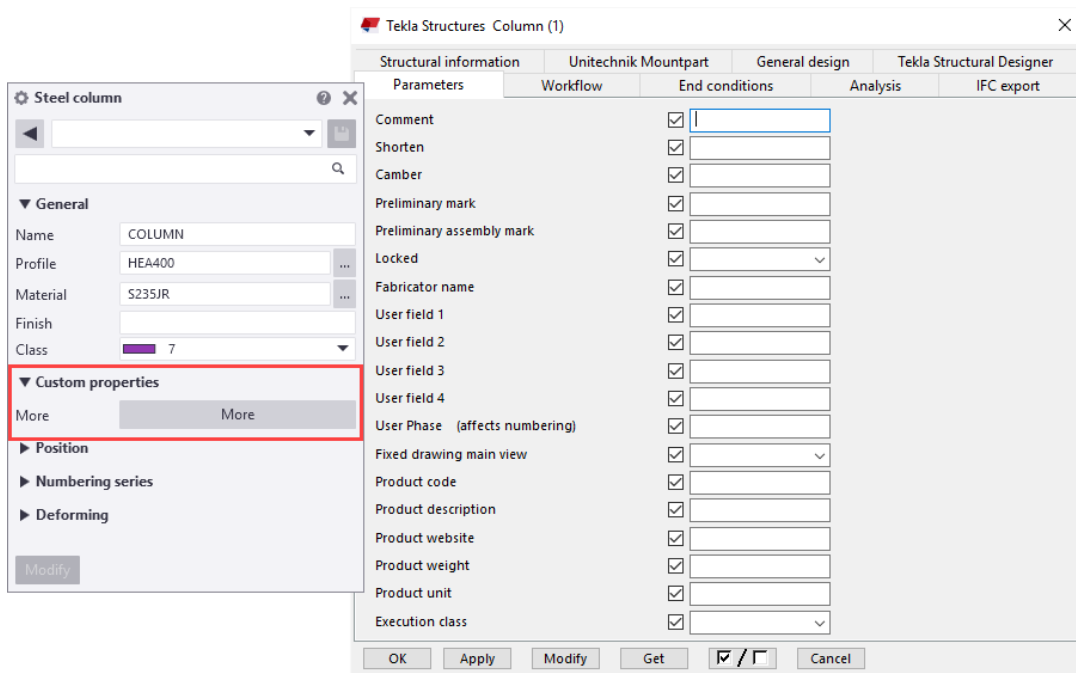

You can [create your own user-defined attributes \(page 308\)](#) that you need in your company, or for a specific project. The user-defined attributes can be numbers, text, lists, or dates. They can be set to be unique for an object or allowed to be copied; they can also be ignored by numbering or affect numbering.

The user-defined attributes are defined in `objects.inp` files. These files are located in different folders following the Tekla Structures folder setup, and they are merged together during startup. The `objects.inp` file reads the

user-defined attributes in order from the folders listed below, starting from the model folder:

Folder defined by advanced option	Advanced option
Model	Current model folder
Project	XS_PROJECT (your defined project folder)
Firm	XS_FIRM (your defined firm folder)
System	XS_SYSTEM (your defined system folder)
inp	XS_INP (your defined inp folder)

The files are merged so that if there are user-defined attributes in any of the files, they are displayed in the user interface. Tekla Structures merges the files so that duplicate attributes are removed. If Tekla Structures encounters the same attribute name in different `objects.inp` files, the attribute from the first read `objects.inp` file will be used.

If you need to have several `objects.inp` files in the same folder, you can use a suffix in the file name to use all the files. This enables having several `objects_<suffix>.inp` files in the same folder. The file name could be `objects_precast.inp`, for example.

5 Create and distribute customized settings, user interface elements, and catalogs

Tekla Structures settings are managed on several layers, and many of the settings can be customized to meet the needs of your company and projects.

If you are not yet familiar with the different files and folders that are essential to get Tekla Structures working as efficiently as possible, see [Implementation guide for administrators \(page 111\)](#) before you start customizing.

Customize modeling and drawing settings

In addition to Trimble's default settings, you can create your company's general settings and project-specific settings. See [Environment, company, and project settings for administrators \(page 125\)](#).

Share customized user interface elements

Also, many user interface elements can be customized and distributed to all the users in a company. You can distribute

- [customized ribbons \(page 132\)](#)
- [customized tabs \(page 134\)](#)
- [customized property pane layouts \(page 137\)](#) and
- [customized toolbars \(page 138\)](#).

Customize catalogs and databases

You can customize catalogs and databases for

- [profiles \(page 147\)](#)
- [materials \(page 139\)](#)

- [shapes \(page 210\)](#)
- [bolts \(page 229\)](#)
- [rebars \(page 246\)](#) and
- [applications and components \(page 257\)](#).

Check, for example, the profile and material needs for your project, and if needed, clean up the catalogs and databases so that they contain the relevant content for your project. This helps you to simplify your work and avoid mistakes. Always ensure that the catalog content is correct. Mistakes in catalogs may be hard to detect, but if left unnoticed, they may lead to serious inconsistencies in quantity information, data transfer, or elsewhere. For example, wrong material density will lead to systematic errors in reported weights.

If necessary, you can add new content to the catalogs from other environments, from [Tekla Warehouse](#), or you can import content created in other software solutions.

5.1 Environment, company, and project settings for administrators

Tekla Structures settings are managed on several layers. On the highest layer there are hard-coded default settings which cannot be changed but which you can override on the following layers.

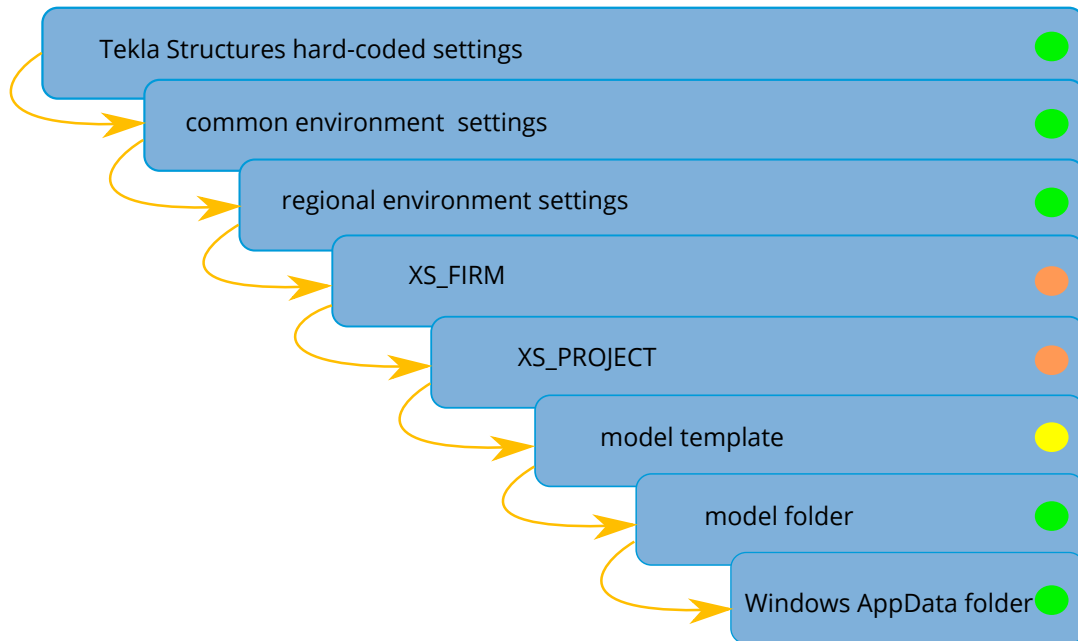

- These settings are constantly active
- Tekla Structures reads these settings when a model is opened
- Tekla Structures reads these settings when a model is created

- Common environment settings that have preset values included in the installation. These can be modified or removed. The common environment is usually always included in the installation.
- Regional environment settings with preset values that are suited for specific regional areas.

If needed, you can clean up the common environment and the selected regional environment of the files that you do not need.

- Advanced option `XS_FIRM` that defines a folder, typically on a network drive, that loads settings for all users within your company.

This folder is the main container of files for the company.

- Advanced option `XS_PROJECT` that defines a folder, typically on a network drive, that loads higher-ranking settings for all users within a specific project.

- Model template that is loaded from the environment, or from the network folders. The model template is loaded only once when you start creating a new model.
- Model folder content that is saved locally when you add or edit settings.
Note that if you save content in the model folder, the presaved settings in other locations will override the same settings found in the model folder.
- Windows AppData folder for user-specific settings related to the Tekla Structures user interface.

Environment settings

Common settings

All settings and files that are the same in all environments are located in the `\Tekla Structures\<>version>\Environments\common` folder. Files and settings that are specific to an environment are located in separate environment folders.

The `env_global_default.ini` file is also located in the `\common` folder. The file determines the standard settings, and it is the first file that is read. Other [initialization files \(page 271\)](#) are read after this file, and if the other files contain the same settings, they will override the previous settings.

Country-specific settings

The country-specific, or region-specific, settings are located in the environments folders, and they are localized by your local Trimble office/reseller. The folder structure of the environments can vary, but the same kind of settings exist. For example, the settings that are localized include profile database, material database, reports, selection filters, view filters, components and custom components, macros, user-defined attributes, and drawings settings.

Company settings

Company-level settings are mainly settings that are used throughout the company for all projects. These settings are set using `XS_SYSTEM` and `XS_FIRM`.

For a larger company with subsidiaries, the settings could be used as follows:

- `XS_SYSTEM` may contain multiple paths, and it points to general settings inside the company. These can be company logo, reports, printer settings, drawing settings, templates, for example. These are settings that very seldom change, and are stored on a server available for all. For example, if the company logo is updated, it only has to be replaced in one place.

- `XS_FIRM` points to the firm folder set up by the company, or a subsidiary. The folder contains all the company settings used at the particular office. These can be logos, drawing settings, templates, reports, or printer settings, for example. The firm folder can also have user-defined sub-folders for storing property files.
- `XS_PROJECT` points to the project folder. The folder contains project settings, such as logos for contractors and fabricators, or drawing settings, for example. The project folder can also have user-defined sub-folders for storing project-specific property files.

For more information on the folder search order, see [Folder search order \(page 361\)](#).

You can also use Tekla Warehouse company-specific collections online or offline, in your own network. Use Trimble Identity for downloading or installing from the online collections. See also [Trimble Identity for Tekla Online services](#).

The offline collection access is managed with folder rights in your network, and on the collection level in the `collections.json` file on each user's computer.

```
"collections"
"\\\\server-A\\company\\Tekla Structures collection"
```

The `collections.json` file can be shared to selected persons by copying it to the `C:\Users\Public\Documents\Tekla\Tekla Warehouse\` folder.

Model templates

You can save a model with the desired settings and use the model as a template when you create new models. This can be very useful if your company has different kinds of projects, such as, parking garages, office buildings, bridges, and industrial.

When you create a model template, always start by creating a new empty model. This is because old models that have been used in live projects cannot be completely cleaned. They may contain excess information that increases the size of the model even if you delete all objects and drawings from the model.

To create a model template:

1. Create a new model and give it a unique name.
2. Add in the model the desired profiles, custom components, and other necessary items.
3. On the **File** menu, click **Save as** --> **Save**.

You need to save the model to include custom components in the `xslib.db1` file. If you do not save the model, custom components will not be included in the model template.

4. On the **File** menu, click **Save as** --> **Save as model template**.

5. Enter a name for the model template, and select which catalogs, drawing templates, report templates, and model subfolders you want to include in the model template.
6. Click **OK**.

By default, the model template folder is saved in your environment folder, under `..ProgramData\Trimble\Tekla Structures\<version>\environments\<your environment>\`. The exact folder location may vary depending on your environment and role. Use the advanced option `XS_MODEL_TEMPLATE_DIRECTORY` to define a different location.

You can download, share, and store model templates in [Tekla Warehouse](#). The image below shows an example of a model template in Tekla Warehouse.

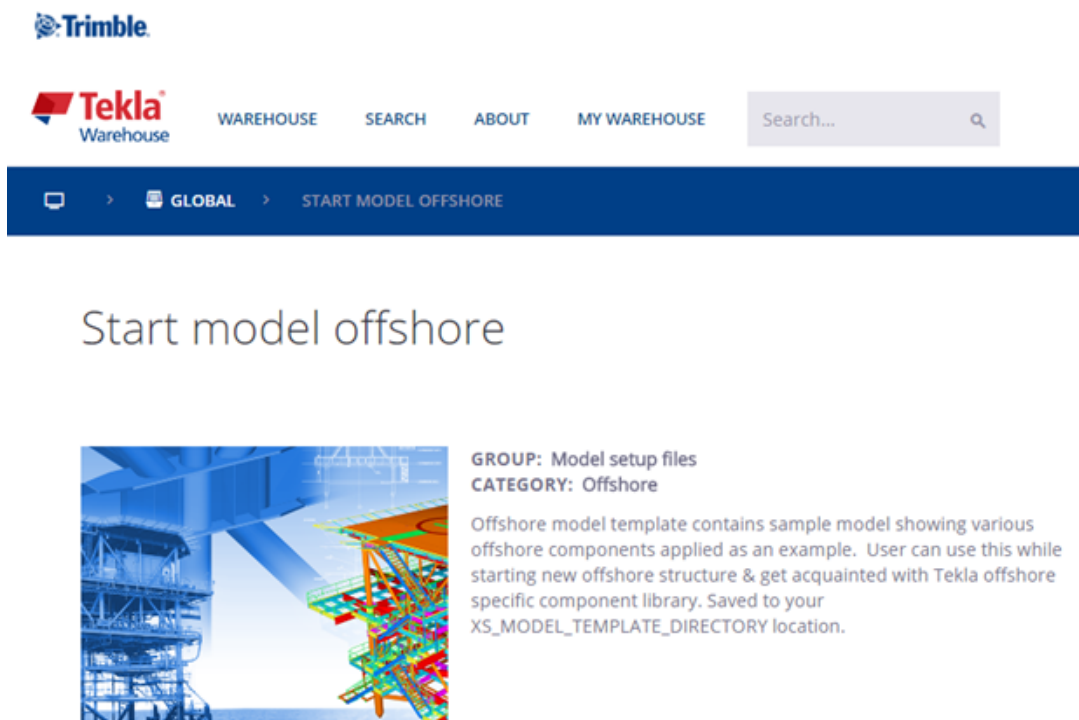

The **Insert into model** button in Tekla Warehouse installs the model template directly in the folder pointed by `XS_MODEL_TEMPLATE_DIRECTORY`. You can immediately use the template when creating a new model.

Model templates in Tekla Structures version update

We strongly recommend that you update your model templates in Tekla Structures version upgrade.

To update a model template:

1. Create a new model using an existing model template.
2. Give the model the same name as in the previous Tekla Structures version.
3. Open a 3D view.

4. On the **File** menu, click **Diagnose and repair --> Diagnose model**.
5. On the **View** tab, click **Screenshot --> Project thumbnail** to create a project thumbnail, or add a custom image named `thumbnail.png` in the model folder.
The preferred size of the image is 120 x 74 pixels.
6. On the **File** menu, click **Save as --> Save**.
If you do not do this, a message may appear warning about the model being created with a previous version.
7. On the **File** menu, click **Save as --> Save as model template**.
8. Select which catalogs, drawing templates, report templates, and model subfolders you want to include in the model template.
9. Click **OK**.
10. Remove manually all `*.db` files (environment database, options database files) from the model folder.

The `*.bak`, `*.log` and `xs_user` files are automatically removed from the model folder.

Do not remove the `.idrm` files (`db.idrm` and `xslib.idrm`) as they are part of the model.

The model template is saved in a location pointed by `XS_MODEL_TEMPLATE_DIRECTORY`.

You now have a sample image for your model template. The **Applications & components** catalog is now also in order and easy to use.

Customizing reports and drawings

If your company already has graphical templates in the DXF, DWG, or DGN format, you can convert these templates to Tekla Structures templates. For detailed instructions on how to do this, see the information on AutoCAD and Microstation files in the Template Editor Help.

For information on how to create your own templates and reports, see the Template Editor Help, and [Templates \(page 366\)](#).

Cloning templates for drawings

You should consider cloning drawings when:

- There are several similar parts, assemblies, or cast units in the model.
- You need to produce single-part, assembly, or cast-unit drawings of similar parts, assemblies, or cast units.
- The drawings need a lot of manual editing.

For example, you can create a drawing for one truss, edit the drawing, and then clone it for similar trusses. Then you only need to modify the cloned drawings where the trusses differ.

The cloned drawing may contain more parts than the original drawing. Part properties, marks, associative notes and related text objects are cloned from a similar part in the original drawing.

Clone templates in Master Drawing Catalog

You can clone drawings by using the **Master Drawing Catalog** templates. A cloning template in the **Master Drawing Catalog** can also be used in other models. They can be used in projects that have the same kind of drawings.

To create cloning templates:

1. Select a drawing in **Document manager**.
2. Right-click and select **Add to Master Drawing Catalog**, and then fill in the required properties.

The cloning template can be found under **Cloning templates** in the **Master Drawing Catalog**. To use cloning templates in other models, open the **Master**

Drawing Catalog in the model, click the  button on the toolbar, and add the model where the templates are saved.

For more information on the **Master Drawing Catalog** and cloning templates, see [Create drawings in Master Drawing Catalog](#).

Project settings

Create your own component folder

Usually, only a few different connections and components are used in a project. To ensure that everyone in the project uses the same components and finds the components faster, we recommend that you create a component folder of your own.

1. Click the **Applications & components** button  in the side pane to open the **Applications & components** catalog.
2. Create a new group for the project: Right-click in the catalog and select **New group**.
3. Add components to the group: Select the components in the catalog, right-click and select **Add to group**. Then select the group to which the components are added. You can also drag the selected components to another group.
4. Hide the groups that you do not need: Select the group, right-click and select **Hide/Unhide**.

TIP In the **Applications & components** catalog, use the commands in

Access advanced features  **> Catalog management** to modify catalog definitions. For more information, see [Customize the](#)

[Applications & components catalog \(page 257\)](#) and `XS_COMPONENT_CATALOG_ALLOW_SYSTEM_EDIT`.

For more information on the **Applications & components** catalog, see [How to use the Applications & components catalog](#).

Define project properties

Project information is needed many times during a project. Define the project information at the beginning of a project to make reports and drawings display the correct information automatically. You can also update the project properties during the project.

1. On the **File** menu, click **Project properties**.
2. Edit the project properties.
When you edit the properties, Tekla Structures highlights the modified properties in yellow.
3. When you are ready with the modifications, click **Modify** to apply the changes.

Create and modify templates and reports

You can modify existing reports and templates, or create your own [templates \(page 366\)](#) by using Template Editor. To open Template Editor, click **File --> Editors --> Template editor**, or double-click an existing table in an open drawing to open the tool. For more information, see [Template Editor User's Guide](#).

Note that if your templates are located in a protected folder, the templates are read-only, and you cannot save a modified template in a protected folder. In this case, run Tekla Structures as an administrator.

Set up printers

Tekla Structures uses Windows drivers to write the print data directly to the Windows print device interface. You can print drawings as PDF files, save them as plot files (`.plt`) for printing with printer/plotter, or print them on a selected printer. To print to several paper sizes, you need to modify the `drawingsizes.dat` file, see more in [Configuration files used in printing](#). You can also change the line width of the printed drawings, see more in [Print to a .pdf file, plot file \(.plt\) or printer and Line thickness in drawings](#).

You can affect the way Tekla Structures automatically names the `.pdf` files and plot files by using certain drawing-type-specific advanced options, see more in [Customize print output file names](#).

5.2 Distribute customized ribbons by using a firm or environment folder

Company administrators can distribute the customized ribbon files to other users in the company by placing the ribbon files in a firm or environment folder (not in the project folder). For example, the administrator can create company ribbons and save them in the firm folder. These ribbons will be displayed in the Tekla Structures user interface for all users who use the same firm folder.

Add ribbons to a firm or environment folder

1. In the Ribbon editor, create the modeling and drawing ribbons that you want to share.

The ribbons are saved in the `.. \Users\<user>\AppData\Local\Trimble\Tekla Structures\<version>\UI\Ribbons` folder.

If you cannot find the folder, ensure that you are able to view the [hidden files and folders \(page 364\)](#) on your computer.

2. Copy the entire `\Ribbons` folder either to your company's firm folder or to the system folder.
3. If the ribbon contains user-defined commands, create a sub-folder named `\Commands` on the same level as the `\Ribbons` folder, and copy the `UserDefined.xml` file from the `.. \Users\<user>\AppData\Local\Trimble\Tekla Structures\<version>\UI\Commands` folder to the `\Commands` folder you just created.
4. Restart Tekla Structures.

Loading order of custom ribbons

Tekla Structures loads the ribbons in the following order:

1. Tekla Structures default ribbon
2. Company ribbons in the environment folders
3. Company ribbons in the firm folder
4. User-defined ribbons under `%localappdata%`

Note that the ribbons which are loaded later will override previously loaded ribbons that have the same configuration + editing mode combination. For example, a ribbon defined in the firm folder will take precedence over the ribbons in the environment folders.

If you have a customized ribbon in the `.. \Users\<user>\AppData\Local\Trimble\Tekla Structures\<version>\UI\Ribbons` folder, it will take precedence over company ribbons. To override this, open the Ribbon editor

and click **Restore**. The ribbon in the environment or firm folder will now be used. Alternatively, you can remove or rename your own customized ribbons.

Naming convention for ribbon files

The customization tool saves the custom ribbons as .xml files. The naming convention for these files is:

```
<Tekla-Structures-configuration_identifier>--<Tekla-Structures-editing-mode>.xml
```

The name consists of an internal configuration name, a separator of two dash characters (--), an internal editing mode name, and the file name extension .xml. For example, the **Full** license modeling ribbon is called `albl_up_Full--main_menu.xml`.

Configuration identifier	Configuration name
albl_up_Diamond	Tekla Structures Diamond
albl_up_Graphite	Tekla Structures Graphite
albl_up_Carbon	Tekla Structures Carbon
albl_up_Construction_Modeling	Construction Modeling
albl_up_Developer	Developer
albl_up_Drafter	Drafter
albl_up_Educational	Educational
albl_up_Engineering	Engineering
albl_up_Full	Full
albl_up_PC_Detailing	Precast Concrete Detailing
albl_up_Rebar_Detailing	Rebar Detailing
albl_up_Steel_Detailing	Steel Detailing
albl_up_Tekla_Structures_Primary	Primary
albl_up_Viewer	Project Viewer

Editing mode	Purpose
main_menu	Modeling ribbon
edit_draw_menu	Drawing ribbon
plan_main_menu	Importing ribbon

5.3 Distribute customized tabs by using a firm or environment folder

As an alternative to customized ribbon files, which override the existing ribbon, you can distribute customized tabs to other users in the company by placing the tab files in a firm or an environment folder (not in a project folder). The customized tabs are automatically appended to the end of the ribbon for all users who use the same firm or environment folder. This means that an administrator can distribute customizations to all users in the company while still allowing individual users to customize their ribbons as well.

Note that these customized tabs do not appear in the Ribbon editor, so the users are not able to edit them. If the administrator has updated the contents of a customized tab, the users will receive an update when they restart Tekla Structures. Tabs are not configuration specific, so they are imported regardless of the user's Tekla Structures license. If the tab contains commands that are not available in the user's configuration, they will appear dimmed on the ribbon.

NOTE If you use a firm folder to distribute the custom tabs, you need to set the firm folder path in an `.ini` file, for example, in `user.ini`, `teklastructures.ini`, `project.ini` or in `company.ini`. If you set the firm folder path in the advanced option **XS_FIRM**, the tab file does not work correctly, because the **XS_FIRM** definition in advanced options is made on the model level and it is too late for the custom tab to be initialized.

1. Create the following folder structure in your company's firm folder or in the system folder.

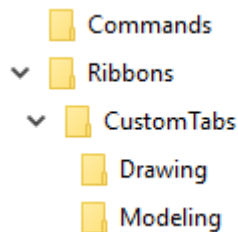

2. In the Ribbon editor, create a customized tab and add some commands to it.
3. Save the ribbon.
4. Go to the `..\Users\\AppData\Local\Trimble\Tekla Structures\\UI\Ribbons` folder.
5. Open the ribbon `*.xml` file, which contains the tab you wish to share with other users, in a text editor, for example, Microsoft Notepad.
6. Remove all the other content from the ribbon file except the first row and the description of the tab you wish to share.

Alternatively, you can copy the needed content in a new text file.

For example:

```
<?xml version="1.0" encoding="utf-8" standalone="yes"?>
<Tab Header="My Tab" IsCollapsed="false" IsUserDefined="true">
  <SimpleButton X="0" Y="0" Width="3" Height="4"
Command="Common.Interrupt" Text="command:ShortText" Icon="myicon.png"
ShowText="true" ShowIcon="true" />
  <SimpleButton X="3" Y="0" Width="3" Height="4"
Command="RibbonEditor.Open" Text="command:ShortText" Icon="somefolder
\myicon2.png" ShowText="true" ShowIcon="true" />
</Tab>
```

The button icons use relative paths. The icon path is relative to the *.xml file where tab is read from. For example `Icon="myicon.png"` refers to an icon in the same folder as the *.xml file, and the `Icon="somefolder\myicon2.png"` refers to an icon in a sub-folder.

Alternatively, you can also go folders back: `Icon="..\myicon.png"`.

7. Save the *.xml file with a new name in the ..\CustomTabs\Modeling or ..\CustomTabs\Drawing folder.

Tab files have the file name extension *.xml. We recommend that you use the same name as for the tab. For example, MyTab.xml. The file name is not case sensitive.

The tab will be added to either the modeling or drawing mode ribbons, depending on the folder it is located in. Note that there can be several custom tab files in the same folder. They are added to the ribbon one after the other. If the same tab file exists in both the environment and firm folders, the firm version overrides the environment version.

NOTE To avoid file name conflicts, we recommend that administrators prefix all custom tab files with the company name, and that extension developers prefix all custom tab files with the name of the extension (for example, MyExtension_TabName.xml).

8. If the tab contains user-defined commands, copy the UserDefined.xml file from the ..\Users\<user>\AppData\Local\Trimble\Tekla Structures\<version>\UI\Commands folder to the \Commands folder created in step 1.
9. Restart Tekla Structures.

The customized tab now appears at the end of the ribbon.

See also

[Create and distribute customized settings, user interface elements, and catalogs \(page 124\)](#)

[Distribute customized ribbons by using a firm or environment folder \(page 132\)](#)

5.4 Distribute customized property pane layouts by using a project, firm, or environment folder

Company administrators can distribute the customized property pane layouts to other users in the company by placing the property pane layout file `PropertyTemplates.xml` in a folder called `PropertyRepository\Templates` in a project, firm, or environment folder. For example, company administrators can create company property pane layouts and save them in the firm folder. These property panes are available in the Tekla Structures user interface for all users who use the same firm folder.

Add a property pane layout file to a project, firm, or environment folder

1. In the Property pane editor, create the property pane layouts that you want to share.

The property pane layouts are saved in the `PropertyTemplates.xml` file, in the `..\Users\\AppData\Local\Trimble\Tekla Structures\\UI\PropertyTemplates` folder.

If you cannot find the folder, ensure that you are able to view the [hidden files and folders \(page 364\)](#) on your computer.

2. Create a folder called `PropertyRepository\Templates` either in your company's project folder, firm folder, or in the system folder.
3. Copy the `PropertyTemplates.xml` file to the `PropertyRepository\Templates` folder.
4. Restart Tekla Structures.

Search order of the customized property pane layout files

The `PropertyTemplates.xml` file contains all the property pane layouts for different object types. Note that the property pane layouts for different object types are treated separately. For example, Tekla Structures can read the property pane layout for steel beam from a different location than the property pane layout for steel column.

If different object types are defined in different folder locations, the definitions are combined. If the same object type is defined differently in different folder locations, the definition that is higher in the search order is used.

The property pane layout in the `..\Users\\AppData\Local\Trimble\Tekla Structures\\UI\PropertyTemplates\` folder has the highest priority, and after that Tekla Structures uses the default search order.

5.5 Distribute customized property pane settings by using a project, firm, or environment folder

Company administrators can distribute the customized property pane settings to other users in the company. Place the `PropertyPaneSettings.xml` file in a folder called `\PropertyPane` in a project, firm, or environment folder.

1. Customize the property pane settings that you want to share.

The property pane settings are saved in the `PropertyPaneSettings.xml` file, in the `..\Users\\AppData\Local\Trimble\Tekla Structures\\UI\PropertyPane\` folder.

If you cannot find the folder, ensure that you are able to view the [hidden files and folders \(page 364\)](#) on your computer.

2. Create a folder called `\PropertyPane` either in your company's project folder, firm folder, or in the system folder.
3. Copy the `PropertyPaneSettings.xml` file to the `\PropertyPane` folder.
4. Restart Tekla Structures.

The file in `..\Users\\AppData\Local\Trimble\Tekla Structures\\UI\PropertyPane\` has the highest priority in the search order, and after that Tekla Structures uses the default search order.

If the `PropertyPaneSettings.xml` file is placed in several different folder locations, Tekla Structures reads the settings from different folders and merges them.

See also

[Create and distribute customized settings, user interface elements, and catalogs \(page 124\)](#)

5.6 Distribute customized toolbars by using a project, firm, or environment folder

Company administrators can distribute the customized **Selecting**, **Snapping**, and **Snap override** toolbars to other users in the company. Place the needed toolbar `.json` files in a folder called `\Toolbars` in a project, firm, or environment folder. For example, company administrators can create company toolbars and save them in the firm folder. These toolbars are available in the Tekla Structures user interface for all users who use the same firm folder.

1. Customize the toolbars that you want to share.

The toolbars are saved in corresponding `.json` files, in the `..\Users\<user>\AppData\Local\Trimble\Tekla Structures\<version>\Toolbars` folder.

If you cannot find the folder, ensure that you are able to view the [hidden files and folders \(page 364\)](#) on your computer.

2. Create a folder called `\Toolbars` either in your company's project folder, firm folder, or in the system folder.
3. Copy the needed `.json` files to the `\Toolbars` folder.
4. Restart Tekla Structures.

The files in `..\Users\<user>\AppData\Local\Trimble\Tekla Structures\<version>\Toolbars` have the highest priority in the search order, and after that Tekla Structures uses the default search order.

See also

[Create and distribute customized settings, user interface elements, and catalogs \(page 124\)](#)

5.7 Customize the material catalog

The material catalog contains information on material types and grades. In the material catalog, materials are displayed in a hierarchical tree grouped according to their types. Each material type has material grades listed under them.

The following material types are available in Tekla Structures:

- Steel
- Concrete
- Reinforcing bar
- Timber
- Miscellaneous

By default, the material catalog contains standard, environment-specific materials. You can add, modify, and delete material grades.

Tekla Structures stores the material information in the `matdb.bin` file.

See also

[Important buttons in the material catalog \(page 140\)](#)

[Add a material grade \(page 140\)](#)

- [Copy a material grade \(page 141\)](#)
- [Modify a material grade \(page 142\)](#)
- [Delete a material grade \(page 142\)](#)
- [Add user attributes to material grades \(page 143\)](#)
- [Create user-defined material definitions \(page 144\)](#)
- [Import and export material grades \(page 145\)](#)

Important buttons in the material catalog

When you work with the material grades, note the usage of the following buttons in the **Modify Material Catalog** dialog box:

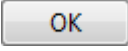
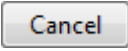
Button	Description
	Saves the changes of a single edited material grade to the computer's memory until you click OK .
	Saves the changes in the model folder. Tekla Structures saves the modified catalog on the hard disk when you click OK to close the dialog box and then click OK in the Save confirmation dialog box.
	Closes the Modify Material Catalog dialog box without saving the changes. Note that all changes made to the catalog will be lost even if you have clicked Update , because the changes have not been saved on the hard disk. The changes made to the catalog are visible during one session, because the catalog is using the computer's memory. When you start Tekla Structures the next time, the previous data is restored from the hard disk.

Tekla Structures stores the material information in the `matdb.bin` file. When you first open a model, Tekla Structures reads the data from the hard disk and stores it in the computer's memory.

When you select a material, Tekla Structures reads the data from the computer's memory and displays it in the **Modify Material Catalog** dialog box. This is faster than accessing the data from the hard disk.

See also

[Customize the material catalog \(page 139\)](#)

Add a material grade

1. On the **File** menu, click **Catalogs** --> **Material catalog** to open the **Modify Material Catalog** dialog box.
2. Select a material type, for example, steel.
3. Right-click and select **Add Grade**.
A new material grade is added under to the material type you selected.
4. Change the material grade name by clicking the grade and entering a new name for it.
5. Enter the material grade properties.
6. Click **OK** to save the material grade and close the **Modify Material Catalog** dialog box.
7. Click **OK** in the **Save confirmation** dialog box to save the changes.

See also

[Copy a material grade \(page 141\)](#)

[Modify a material grade \(page 142\)](#)

[Delete a material grade \(page 142\)](#)

[Import and export material grades \(page 145\)](#)

Copy a material grade

You can add new material grades by modifying a copy of an existing, similar material grade.

1. On the **File** menu, click **Catalogs** --> **Material catalog** to open the **Modify Material Catalog** dialog box.
2. Select a material grade that is similar to the one you wish to create.
3. Right-click and select **Copy Grade**.
A copy of the material grade with the name **COPY** is added to the material tree.
4. Change the material grade name by clicking the grade and entering a new name for it.
5. Modify the material grade properties.
6. Click **OK** to save the material grade and close the **Modify Material Catalog** dialog box.
7. Click **OK** in the **Save confirmation** dialog box to save the changes.

See also

[Add a material grade \(page 140\)](#)

[Modify a material grade \(page 142\)](#)

[Delete a material grade \(page 142\)](#)

Modify a material grade

You can modify existing material grades using the material catalog.

1. On the **File** menu, click **Catalogs** --> **Material catalog** to open the **Modify Material Catalog** dialog box.
2. Select a material grade in the tree and modify its properties.
 - Use the **General** tab for entering three alternative names for the material. The names are usually the material names used in different countries or standards. The tab also contains the profile and plate density values.
 - Use the **Analysis** tab for entering information on the properties used in structural analysis.
 - Use the **Design** tab for entering information on the design-specific properties, such as strengths and partial safety factors.
 - Use the **User attributes** tab for creating your own attributes for material grades.

For example, you can define a paint layer thickness, or the maximum grain size of concrete using a user-defined attribute.
3. When you have finished modifying the material grade, click **Update**.
4. Click **OK** to close the **Modify Material Catalog** dialog box.

Tekla Structures asks if you want to save the changes to the model folder.
5. Click **OK** in the **Save confirmation** dialog box to save the changes.

The modified material catalog is saved in the current model folder and is available only for that model. To make the modified catalog available for all the other models, use export and import.

See also

[Add a material grade \(page 140\)](#)

[Copy a material grade \(page 141\)](#)

[Delete a material grade \(page 142\)](#)

Delete a material grade

1. On the **File** menu, click **Catalogs** --> **Material catalog** to open the **Modify Material Catalog** dialog box.
2. Select the material grade that you want to delete.
3. Right-click and select **Delete Grade**.
4. Click **OK** to close the **Modify Material Catalog** dialog box.
5. Click **OK** in the **Save confirmation** dialog box to save the changes.

See also

[Add a material grade \(page 140\)](#)

[Copy a material grade \(page 141\)](#)

[Modify a material grade \(page 142\)](#)

Add user attributes to material grades

You can add user attributes and their values to the material grades. The user attributes can then be used, for example, in filtering.

1. On the **File** menu, click **Catalogs** --> **Material catalog** to open the **Modify Material Catalog** dialog box.
2. On the **User attributes** tab, click **Definitions** to open the **Modify Material Properties** dialog box.
3. Click **Add** to add a new row.
4. To define a user attribute, click each item on a row.
 - a. In the **Category** list, select a material category to which the user attribute is applied.
 - b. In the **Design code** list, select a design code to which the attribute is added.
 - c. In the **Material type** list, select a material type for the attribute.
 - d. In the **Quantity type** list, select the type of information that the user attribute contains, for example, weight, area, ratio, or string.
 - e. In the **Order** column, define the order in which the user attributes are shown in the dialog box. Smaller values are shown first.
 - f. In the **Property name** column, define a name for the property.

The name is saved in the catalog and can be used in reports and templates. When **Property name** is used in a template, `MATERIAL.PROPERTY_NAME` indicates where the property name appears.
 - g. In the **Label** column, define a label for the attribute.

5. Click **Update**.
6. Click **OK** to close the **Modify Material Properties** dialog box.

See also

[Modify a material grade \(page 142\)](#)

Create user-defined material definitions

You can replace the existing material definitions with your own definitions and use them, for example, in drawing part marks. Material definitions can contain text, numbers and symbols.

1. Save the symbol file `user_material_symbols.sym` in the symbol folder (usually the folder `..\ProgramData\Trimble\Tekla Structures\<version>\environments\common\symbols\`).
2. Create a text file that contains your material definitions.

Create the file using a text editor, for example Microsoft Notepad.

Each row in the file defines a material. Use the following syntax:

`material_name symbol_file_name@n`, where

- `material_name` is the name of the material used in the material catalog
- `symbol_file_name` is the symbol file name to be used
- `n` is the number of the symbol.

For example:

```
S235JRG1 user_material_symbols@1 B
S235JRG2 user_material_symbols@2 C
S235JR   user_material_symbols@0 A
S275JR   user_material_symbols@3 D
S355JR   user_material_symbols@4 E
```

WARNING The order of material names in the definition file is relevant to the conversion. Materials with more specific names need to be listed before the ones with similar, but simpler names, for example, S235JRG1 must be listed before S235JR. Otherwise they both get the same symbol.

3. Save the file for example with the name `user_material_definitions.txt`.

All the named materials in the material catalog will be replaced with the ones defined in this file.

4. Set the name of the file as a value for the advanced option `XS_MATERIAL_SYMBOL_REPRESENTATION_FILE` in **File menu** --> **Settings** --> **Advanced options** --> **Drawing Properties** as follows:

```
set
XS_MATERIAL_SYMBOL_REPRESENTATION_FILE=user_material_definitions.txt
```

You can also enter a full path to the material definition file. Without the path Tekla Structures searches for the file in the model, firm, project, and system folders.

See also

[Customize the material catalog \(page 139\)](#)

Import and export material grades

Use importing and exporting for merging material catalogs. Material catalogs are imported and exported as `.lis` files.

Importing and exporting is useful when you:

- upgrade to a newer version of Tekla Structures and want to use a customized material catalog from a previous version
- want to combine material catalogs that are stored in different locations
- want to share material catalog information with other users
- want to combine material catalogs across different environments.

TIP You can also download or share material grades using Tekla Warehouse.

See also

[Import a material catalog \(page 145\)](#)

[Export an entire material catalog \(page 146\)](#)

[Export a part of the material catalog \(page 147\)](#)

[Units used in import and export \(page 160\)](#)

Import a material catalog

Material catalogs are imported to Tekla Structures models as `.lis` files. You can move an exported `.lis` file to any model folder and import it to an existing material catalog.

1. Open the model to which you want to import a material catalog.
2. On the **File** menu, click **Catalogs** --> **Material catalog** to open the **Modify Material Catalog** dialog box.

3. Click **Import**.
4. Browse for the folder that contains the import file, and select the file.
5. Click **OK**.

If a material with a same name as the material being imported already exists, the **Import confirmation** dialog box appears and you have three options:

- **Replace:** The existing material is replaced with the imported material.
- **Merge:** Material properties that are different in the import file are added to the existing material. All the other properties remain unchanged.

Use this option to import only certain elements of the material catalog, such as user attributes.

- **Leave:** The existing material is not replaced and the material definitions in the import file are ignored.

If you select the **Apply for all** check box, Tekla Structures uses the same option (**Replace**, **Merge**, or **Leave**) for all the existing materials that have the same name as the one being imported.

If a user attribute with a different definition already exists, you are prompted to **Replace** or **Leave** the existing attribute.

6. Click **OK** to close the **Modify Material Catalog** dialog box.
7. Click **OK** in the **Save confirmation** dialog box to save the changes.

See also

[Export an entire material catalog \(page 146\)](#)

[Export a part of the material catalog \(page 147\)](#)

[Units used in import and export \(page 160\)](#)

Export an entire material catalog

Exporting and importing are used to merge material catalogs. Material catalogs are exported from Tekla Structures models as `.lis` files. Note that the **Export** command exports the entire catalog.

1. On the **File** menu, click **Catalogs --> Material catalog** to open the **Modify Material Catalog** dialog box.
2. Click **Export**.
3. Browse for the folder where you want to save the exported file.
By default, the file is saved to the current model folder.
4. Enter a name for the file and click **OK**.
5. Click **OK** to close the **Modify Material Catalog** dialog box.

6. Click **OK** in the **Save confirmation** dialog box to save the changes.

See also

[Import a material catalog \(page 145\)](#)

[Units used in import and export \(page 160\)](#)

Export a part of the material catalog

If you do not want to export the whole material catalog, you can export a branch of the material tree, meaning all the material grades grouped under one material type, or a single material grade. Material catalogs are exported from Tekla Structures models as `.lis` files.

1. On the **File** menu, click **Catalogs** --> **Material catalog** to open the **Modify Material Catalog** dialog box.
2. Select material grades to be exported.
 - To export a branch of the material tree, right-click the branch and select **Export Grades**.
 - To export a single material grade, right-click the material grade and select **Export Grade**.
3. Browse for the folder where you want to save the export files.
By default, the file is saved to the current model folder.
4. Enter a name for the file and click **OK**.
5. Click **OK** to close the **Modify Material Catalog** dialog box.
6. Click **OK** in the **Save confirmation** dialog box to save the changes.

See also

[Export an entire material catalog \(page 146\)](#)

[Import a material catalog \(page 145\)](#)

[Units used in import and export \(page 160\)](#)

5.8 Customize the profile catalog

The profile catalog contains information on profiles, their rules and types, and the analysis and design properties of the profiles. Profiles are displayed in a hierarchical tree grouped according to rules.

By default, the profile catalog contains standard, environment-specific profiles and generic parametric profiles. You can add, modify, import, export, and delete profiles.

You can define your own user-defined profiles, which can be either fixed or parametric. Use the profile catalog to create new fixed profiles, either from scratch or by copying an existing one. Use the sketch editor or .clb files to create new parametric profiles.

Tekla Structures stores the profile catalog information in the `profdb.bin` file.

See also

[Important buttons in the profile catalog \(page 148\)](#)

[Group profiles together \(page 149\)](#)

[Add user attributes to profiles \(page 150\)](#)

[Associate profile types with a certain material \(page 154\)](#)

[Delete a profile from the profile catalog \(page 155\)](#)

[Import and export profiles \(page 156\)](#)

[Create your own profiles \(page 163\)](#)

[Define standardized values for parametric profiles \(page 209\)](#)

[Create an image of a profile \(page 209\)](#)

[Customize the shape catalog \(page 210\)](#)

Important buttons in the profile catalog

When you work with the profiles, note the usage of the following buttons in the **Modify Profile Catalog** dialog box:

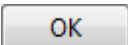
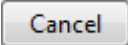
Button	Description
	Saves the changes of a single edited profile to the computer's memory until you click OK .
	Saves the changes in the model folder. Tekla Structures saves the modified catalog on the hard disk when you click OK to close the dialog box and then click OK in the Save confirmation dialog box.
	Closes the Modify Profile Catalog dialog box without saving the changes. Note that all changes made to the catalog will be lost even if you have clicked Update , because the changes have not been saved on the hard disk. The changes made to the catalog are visible during one session, because the catalog is using the computer's memory.

Button	Description
	When you start Tekla Structures the next time, the previous data is restored from the hard disk.

Tekla Structures stores the information of fixed profiles in the `profdb.bin` file. When you first open a model, Tekla Structures reads the data from the hard disk and stores it in the computer's memory.

When you select a profile, Tekla Structures reads the data from the computer's memory and displays it in the **Modify Profile Catalog** dialog box. This is faster than accessing the data from the hard disk.

See also

[Customize the profile catalog \(page 147\)](#)

Group profiles together

In the profile catalog, the profiles are displayed in a hierarchical tree and they are grouped according to rules , such as the profile type (for example, **I profiles**) and the profile subtype (for example, **HEA**). To change how the profiles are grouped in the profile tree, you need to modify the rules.

The order in which you create the rules does not matter, only the location of the rules in the profile tree.

Tekla Structures reads the rules from top to bottom in the profile tree. Profiles are in the highest group where they meet the criteria defined in the rule. For example, a rule that collects **All profiles** overrides all rules that are below it in the profile tree.

See also

[Add a rule to the profile catalog \(page 149\)](#)

[Modify a rule in the profile catalog \(page 150\)](#)

Add a rule to the profile catalog

1. On the **File** menu, click **Catalogs** --> **Profile catalog** to open the **Modify Profile Catalog** dialog box.
2. Right-click any existing rule and select **Add Rule**.
The **Profile manager rules** dialog box appears.
3. Define the rule properties.
 - a. Enter a rule name in the **Rule name** box.
 - b. Select the **Profile type** to which the rule is applied.

- c. Enter the **Name filter string** that defines the new rule.
By default, the wildcard symbol (*) is entered, meaning “all entries”.
For example, to group all catalog entries with names beginning with A, enter A* in the **Name filter string** box, or to group all catalog entries with names containing 100, enter *100*. Tekla Structures groups the catalog entries that meet your criteria under the new rule.
4. Click **OK** to close the **Profile manager rules** dialog box.
5. Click **OK** to close the **Modify Profile Catalog** dialog box.
6. Click **OK** in the **Save confirmation** dialog box to save the changes.

TIP You can add a next level rule that creates a subgroup under an existing rule. Use the **Add Next Level Rule** command to add the next level rule.

See also

[Modify a rule in the profile catalog \(page 150\)](#)

Modify a rule in the profile catalog

1. On the **File** menu, click **Catalogs** --> **Profile catalog** to open the **Modify Profile Catalog** dialog box.
2. Right-click any existing rule and select **Edit Rule**.
The **Profile manager rules** dialog box appears.
3. Modify the rule properties.
4. Click **OK** to close the **Profile manager rules** dialog box.
5. Click **OK** to close the **Modify Profile Catalog** dialog box.
6. Click **OK** in the **Save confirmation** dialog box to save the changes.

Profiles in the profile tree are listed in an alphabetical order, and rules are listed in the order you specify. To change the order in which the rules appear, use the **Move up** and **Move down** commands.

TIP If you want to delete a rule, right-click an existing rule and select **Delete Rule**.

See also

[Add a rule to the profile catalog \(page 149\)](#)

Add user attributes to profiles

You can add your own attributes to profiles. For example, you can specify paint layer thickness, define the maximum grain size of concrete, sort out different profile types by material, or create profile aliases for converting imperial profiles to metric and vice versa.

1. On the **File** menu, click **Catalogs** --> **Profile catalog** to open the **Modify Profile Catalog** dialog box.
2. On the **User attributes** tab, click **Definitions**.
The **Modify Profile Properties** dialog box appears.
3. Click **Add** to add a new row.
4. To define a user attribute, click each item on a row.
 - a. In the **Profile type** list, select a profile type to which the user attribute is applied.
 - b. In the **Quantity type** list, select the type of information that the user attribute contains, for example, weight, area, ratio, or string.
 - c. In the **Order** list, define the order in which the user attributes are shown in the dialog box. Larger values are shown first.
 - d. In the **Property name** list, define a name for the property.
The name is saved in the catalog and can be used in reports and templates. When **Property name** is used in a template, `PROFILE.PROPERTY_NAME` indicates where the property name appears. For example, `PAINT_LAYER_THICKNESS`.
 - e. In the **Symbol** column, define an abbreviation that can be used for the property, such as `Ix` or `ct`.
 - f. In the **Label** column, define a label for the attribute.
5. Click **Update**.
6. Click **OK** to close the **Modify Profile Properties** dialog box.

See also

[Example: Add a user attribute to a profile and use it in a rule \(page 151\)](#)

Example: Add a user attribute to a profile and use it in a rule

You can add your own attributes and their values to profiles. The user attributes can then be used, for example, in profile filtering.

In this example, you will add a user attribute for I profiles' rule.

1. On the **File** menu, click **Catalogs** --> **Profile catalog** to open the **Modify Profile Catalog** dialog box.

2. On the **User attributes** tab, click **Definitions**.
The **Modify Profile Properties** dialog box appears.
3. Click **Add** to add a new row.
4. Select the row that was created and modify the properties as follows:
 - Set **Profile type** to **I profiles**.
 - Set **Quantity type** to **String**.
 - Set **Property name** to `HISTORICAL_PROFILE`.
 - Set **Symbol** to `Hist`.
 - Set **Label** to `Historical profile`.

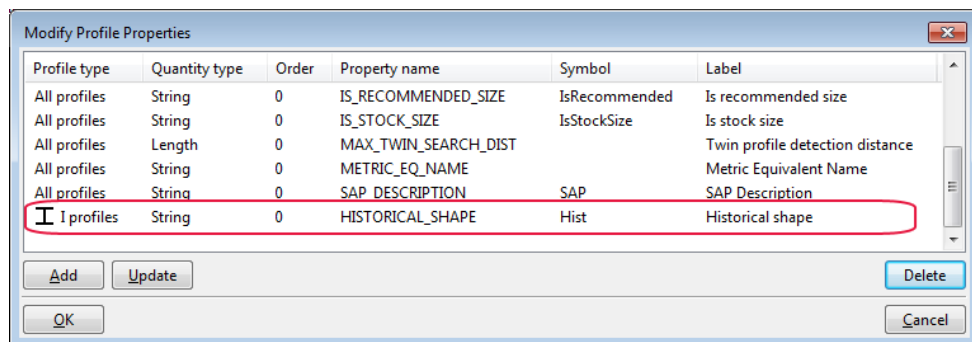

5. Click **Update** and **OK**.
6. In the profile tree, select **I profiles** and then **HEA**.
7. Right-click and select **Add Next Level Rule**.
8. In the **Profile manager rules** dialog box, set the rule properties as follows:
 - Set **Rule name** to `Historical profiles`.
 - In **Profile type**, clear the **All profiles** check box and select the **I profiles** check box.
 - Enter `HEA*` in the **Name filter string** box.

- Set **User attribute** to **HISTORICAL_PROFILE** and **Equals**, and enter **Yes** in the box next to the two other boxes.

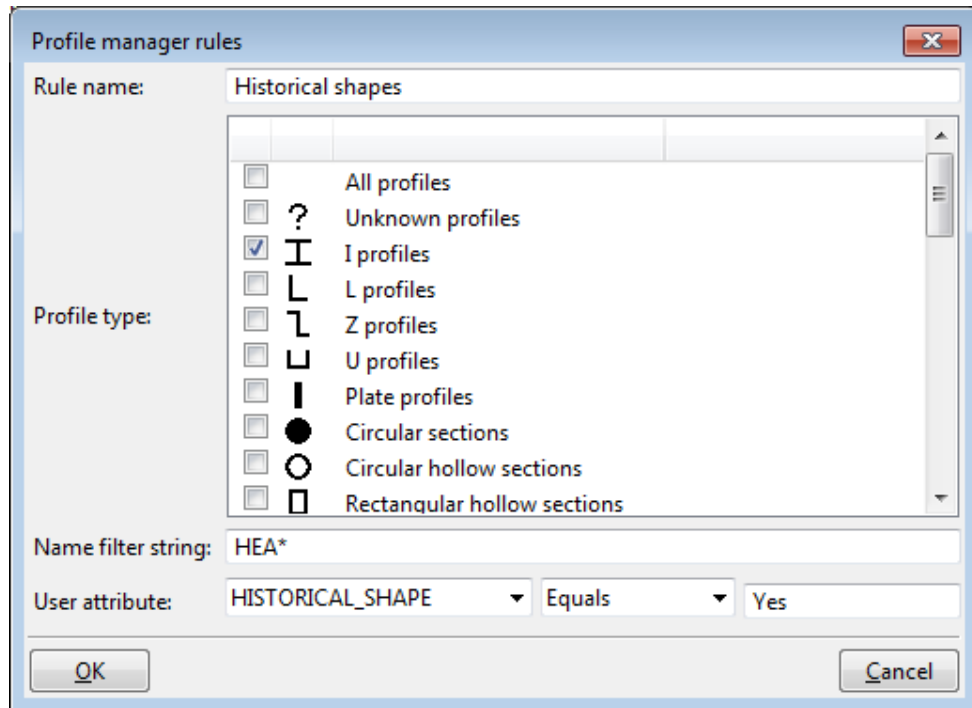

9. Click **OK**.
Historical profiles appears in the profile tree.
10. Select the required historical profile, for example **HEA120**, in the profile tree.
11. Go to the **User attributes** tab and set **Value** of **Historical profile** to **Yes**.

Property	Symbol	Value	Unit
SAP Description	SAP		
Metric Equivalent Name			
Twin profile detection distance		0.00	mm
Is stock size	IsStockSize		
Is recommended size	IsRecommended		
Historical shape	Hist	Yes	
List of factories	FactoryList		
Design order		0	

12. Click **Update**.
13. Repeat the steps 10 and 11 for any other required profiles.

14. Click **OK** to close the **Modify Profile Catalog** dialog box.
15. Click **OK** in the **Save confirmation** dialog box to save the changes.

Next time you open the profile catalog, the profiles appear under **Historical profiles** in the profile tree.

See also

[Add user attributes to profiles \(page 150\)](#)

[Add a rule to the profile catalog \(page 149\)](#)

Associate profile types with a certain material

You can define which profiles are available for steel parts, concrete parts, or both. This affects which profile types are shown in the **Select Profile** dialog box when you change the material of a part.

To define the material of a profile type:

1. On the **File** menu, click **Catalogs --> Profile catalog** to open the **Modify Profile Catalog** dialog box.
2. Select a profile type, for example, **L profiles**.
3. To associate the profiles with steel, right-click and select **Material --> Steel** .

A check mark next to **Steel** indicates that the profiles are available for steel parts.

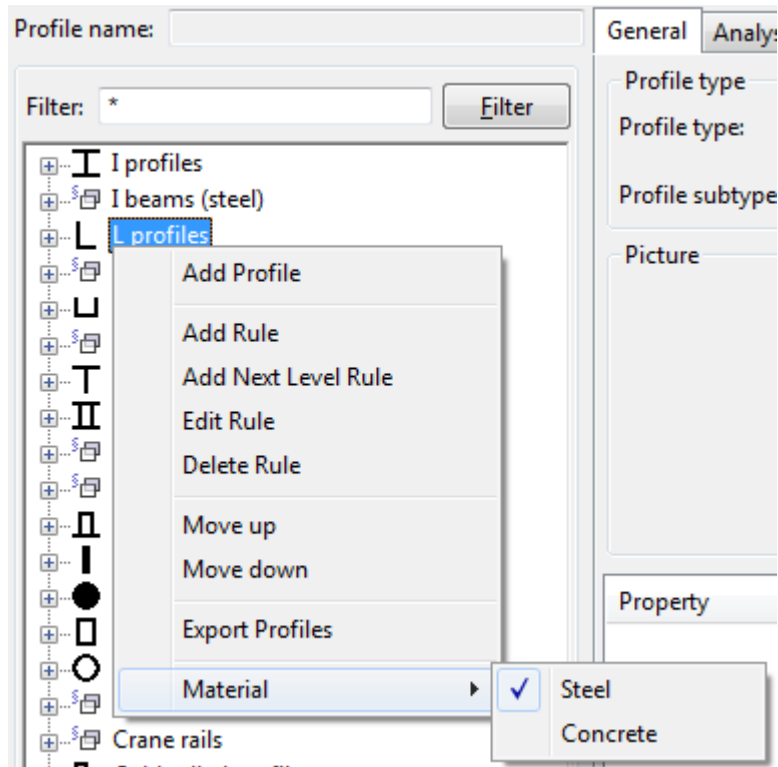

4. To make the selected profiles available also for concrete parts, right-click and select **Material** --> **Concrete** .
If needed, you can remove the check mark by clicking the material again.
5. Click **OK** to close the **Modify Profile Catalog** dialog box.
6. Click **OK** in the **Save confirmation** dialog box to save the changes.

Delete a profile from the profile catalog

1. On the **File** menu, click **Catalogs** --> **Profile catalog** to open the **Modify Profile Catalog** dialog box.
2. Select the profile that you want to delete.
3. Right-click and select **Delete Profile**.
4. Click **OK** to close the **Modify Profile Catalog** dialog box.
5. Click **OK** in the **Save confirmation** dialog box to save the changes.

Tekla Structures will continue showing parts in model views using the deleted profiles until you modify the parts or reopen the model. After that, the parts

having profiles that are not available in the profile catalog, are shown as sticks without a profile.

If the deleted profile used a custom custom cross-section definition, delete it separately to also remove the cross-section from your model.

See also

[Customize the profile catalog \(page 147\)](#)

Import and export profiles

Use importing and exporting for merging profiles across profile catalogs. Profile catalogs are imported and exported as `.lis` files, sketched profiles as `.uel` files, and user-defined parametric profiles as `.clb` files.

When you export an entire profile catalog, Tekla Structures creates three separate files: `profiles.clb`, `profiles.lis` and `rules.lis`. The `.clb` file contains parametric profile definitions, if they are used in the profiles in the catalog, otherwise it is empty. The `profiles.lis` file includes the actual profile definitions and the `rules.lis` file the branch rules. When you export a branch of a profile catalog, the branch name is attached as prefix to the file names.

Importing and exporting is useful when you:

- upgrade to a newer version of Tekla Structures and want to use a customized profile catalog from a previous version
- want to combine profile catalogs that are stored in different locations
- want to share profile catalog information with other users
- want to combine profile catalogs across different environments.

Limitations

- You cannot import or export hard-coded profiles such as `PROFILE_ZZ`, `PROFILE_CC`, and `PROFILE_CW`.
- You cannot import profiles that do not have a defined cross section.
- If you have used a sketched profile or a user-defined parametric profile as the cross section for a fixed profile, you also need to import the sketched profile or the user-defined parametric profile to the new model.

TIP You can also download or share profiles using Tekla Warehouse.

See also

[Export an entire profile catalog \(page 158\)](#)

[Export a part of the profile catalog \(page 158\)](#)

[Import profile catalog items \(page 157\)](#)

[Import and export sketched profiles \(page 162\)](#)

Import profile catalog items

Tekla Structures has five types of profile catalog items: fixed profiles, hard-coded parametric profiles, sketched profiles, user-defined parametric profiles, and rule sets. Profiles and rule sets are imported to Tekla Structures models as `.lis` files, sketched profiles as `.uel` files, and user-defined parametric profiles as `.clb` files.

If you are importing an entire profile catalog or a branch, we recommend that you save the related files in a separate folder. This makes the import process faster.

1. Open the model to which you want to import profile catalog items.
2. On the **File** menu, click **Catalogs** --> **Profile catalog** to open the **Modify Profile Catalog** dialog box.
3. Click **Import** to import a single file, or **Import Directory** to import the contents of a file folder.
4. Select the import file or the import folder.
5. Click **OK**. Tekla Structures checks if there are duplicates in the profile names in the import file compared to the profile catalog.
 - a. If the **Review import items** dialog box appears, there are duplicate profile names and you must select each duplicate and assign the action you want to perform with the following buttons:
 - **Leave**: The existing profile item is not replaced and the profile definitions in the import file are ignored.
 - **Merge**: Profile properties that are different in the import file are added to the existing profile. All the other properties remain unchanged.

Use this option to import only certain elements of the profile catalog, such as user attributes.
 - **Replace**: The existing profile item is replaced with the imported profile item.
 - If you leave **Unknown** as the action for a profile item, it is not imported.

You can select more than one profile item at a time by using the **Shift** and **Ctrl** keys and assign the same action to the entire selection.

NOTE Each cross section definition has a unique name and ID number. If during an import, a cross section with the same name but different properties is found in the existing profile catalog, the cross section being imported is renamed by

adding an incremental number at the end of the existing name.

- b. After you have selected the actions, click **Continue** to perform them.
6. Click **OK** to close the **Modify Profile Catalog** dialog box.
7. Click **OK** in the **Save confirmation** dialog box to save the changes.

See also

[Import and export profiles \(page 156\)](#)

[Export an entire profile catalog \(page 158\)](#)

[Export a part of the profile catalog \(page 158\)](#)

[Import sketched profiles \(page 162\)](#)

[Units used in import and export \(page 160\)](#)

Export an entire profile catalog

Profile catalogs are exported from Tekla Structures models as `.lis`, `.uel`, and `.clb` files.

1. On the **File** menu, click **Catalogs** --> **Profile catalog** to open the **Modify Profile Catalog** dialog box.
2. Click **Export**.
3. Browse for the folder where you want to save the export files.
By default, the files are saved to the current model folder. For faster profile catalog import, we recommend that you create a separate subfolder for the catalog files.
4. Click **OK** to close the **Modify Profile Catalog** dialog box.

See also

[Import and export profiles \(page 156\)](#)

[Export a part of the profile catalog \(page 158\)](#)

[Example of profile export file \(page 159\)](#)

[Import profile catalog items \(page 157\)](#)

[Units used in import and export \(page 160\)](#)

Export a part of the profile catalog

If you do not want to export an entire profile catalog, you can export a branch of the profile tree, meaning all the profiles grouped under one rule, or a single profile. Profiles and rule sets are exported from Tekla Structures models

as `.lis` files, sketched profiles as `.uel` files, and user-defined parametric profiles as `.clb` files.

1. On the **File** menu, click **Catalogs** --> **Profile catalog** to open the **Modify Profile Catalog** dialog box.
2. Select profiles to be exported.
 - To export a branch of the profile tree, right-click the branch and select **Export Profiles**.
 - To export a single profile, right-click the profile and select **Export Profile**.
3. Browse for the folder where you want to save the export files.
By default, the files are saved to the current model folder.
If you are exporting a single profile, enter a name for the file.
4. Click **OK**.
5. Click **OK** to close the **Modify Profile Catalog** dialog box.

See also

[Export an entire profile catalog \(page 158\)](#)

[Example of profile export file \(page 159\)](#)

[Import profile catalog items \(page 157\)](#)

[Units used in import and export \(page 160\)](#)

Example of profile export file

The export `.lis` file is divided into specific sections.

The first row in the file is `PROFILE CATALOG EXPORT VERSION = n`, where `n` is the version number.

WARNING Do not delete this row. If the row does not appear in the file, the import is canceled.

The next section defines the hierarchical tree structure that is used to display the contents of the catalog.

The next section contains the profiles.

Fixed profiles

```
PROFILE_NAME = "HEA120";
{
TYPE = 1; SUB_TYPE = 1001; COORDINATE = 0.000;
{
"FLANGE_SLOPE_RATIO"      0.000000000E+000
"ROUNDING_RADIUS_2"      0.000000000E+000
"ROUNDING_RADIUS_1"      1.200000000E+001
"FLANGE_THICKNESS"       8.000000000E+000
"WEB_THICKNESS"          5.000000000E+000
"WIDTH"                   1.200000000E+002
"HEIGHT"                  1.140000000E+002
```

Fixed user-defined profiles

Fixed user-defined profiles can have more than one cross section. The profile type for fixed user-defined profiles is 998. `SUB_TYPE` refers to the name of the cross section definition. When importing fixed user-defined profiles, the relevant cross section definitions must be in the same import file as the profile.

```
PROFILE_NAME = "TAN_HK_TEST_2_CS";
{
TYPE = 998; SUB_TYPE = 253; COORDINATE = 0.000;
{
"EQUIVALENT_TYPE"        11
"FLANGE_SLOPE_RATIO"     0.000000000E+000
"ECCENTRICITY_Y"         0.000000000E+000
"ECCENTRICITY_X"         0.000000000E+000
"ROUNDING_RADIUS_2"     0.000000000E+000
"FLANGE_THICKNESS_2"    0.000000000E+000
"WEB_THICKNESS_2"       0.000000000E+000
```

Cross section definitions

```
CROSS_SECTION_NAME = "MY_OWN_PROFILE"
POINT_NUMBER = 1;
POINT_X = 200.00;
POINT_Y = -200.00;
CHAMFER_TYPE = 0;
CHAMFER_X = 0.00;
CHAMFER_Y = 0.00;
POINT_NUMBER = 2;
POINT_X = 200.00;
POINT_Y = 200.00;
CHAMFER_TYPE = 0;
CHAMFER_X = 0.00;
CHAMFER_Y = 0.00;
```

See also

[Export an entire profile catalog \(page 158\)](#)

[Export a part of the profile catalog \(page 158\)](#)

Units used in import and export

The table below lists the units Tekla Structures uses when importing and exporting profile catalogs and material catalogs.

Type	Unit (if blank, no unit)
Boolean	
Integer	
String	
Ratio	
Strain	
Angle	degree
Length	mm
Deformation	mm
Dimension	mm
Radius of inertia	mm
Area	mm ²
Reinforcement area	mm ²
Transverse reinforcement area	mm ² /m
Area/unit length	mm ² /m
Volume	mm ³
Section modulus	mm ³
Moment of inertia	mm ⁴
Torsion constant	mm ⁴
Warping constant	mm ⁶
Force	N
Weight	kg
Distributed load	N/m
Spring constant	N/m
Mass/length	kg/m
Surface load	N/m ²
Strength	N/m ²
Stress	N/m ²
Modulus	N/m ²
Density	kg/m ³
Moment	Nm
Distributed moment	Nm/m

Type	Unit (if blank, no unit)
Rotation spring constant	Nm/rad
Temperature	K (°C)
Thermal dilation coefficient	1/K (1/°C)
Factor	

See also

[Import profile catalog items \(page 157\)](#)

[Import a material catalog \(page 145\)](#)

[Export an entire profile catalog \(page 158\)](#)

[Export an entire material catalog \(page 146\)](#)

Import and export sketched profiles

To use a sketched profile in other Tekla Structures models, you have to export the profile to a file (*.uel), and then import the file into another Tekla Structures model.

We recommend that you use the profile catalog to import and export sketched profiles. You can also use the **Applications & components** catalog to import sketched profiles together with related custom components.

See also

[Import sketched profiles \(page 162\)](#)

[Export sketched profiles \(page 163\)](#)

Import sketched profiles

After you have exported sketched profiles to a file, you can import them to another Tekla Structures model.

1. Open the Tekla Structures model you want to import to.
2. On the **File** menu, click **Catalogs** --> **Profile catalog** to open the **Modify Profile Catalog** dialog box.
3. Click **Import**.
4. In the **Import Profile Catalog** dialog box, select *.uel from the **Filter** list.
5. Select the file to import.
6. Click **OK**.
7. Click **OK** to close the **Modify Profile Catalog** dialog box.
8. Click **OK** in the **Save confirmation** dialog box to save the changes.

TIP To automatically import all *.uel files from a folder when creating a new model, use the advanced option XS_UEL_IMPORT_FOLDER.

See also

[Export sketched profiles \(page 163\)](#)

Export sketched profiles

1. Open the Tekla Structures model you want to export from.
2. On the **File** menu, click **Catalogs** --> **Profile catalog** to open the **Modify Profile Catalog** dialog box.
3. Right-click the profile you want to export and select **Export Profile**.
4. In the **Export Profile Catalog** dialog box, enter a name for the export file in the **Selection** box.
5. If you want to save the export file to a specific location, browse for the folder.
By default, Tekla Structures saves the export file in the current model folder.
6. Click **OK**.

See also

[Import sketched profiles \(page 162\)](#)

Create your own profiles

You can create your own profiles and save them in the profile catalog.

Use any of the following methods to create user-defined profiles in Tekla Structures:

Profile type	Creation methods
Fixed profile	<ul style="list-style-type: none">• Create user-defined cross sections (page 164)• Create a fixed profile (page 170)• Create a fixed profile by copying (page 171)• Create a fixed profile based on a parametric profile (page 172)
Parametric profile	<ul style="list-style-type: none">• Create parametric profiles using .clb files (page 173)

Profile type	Creation methods
	<ul style="list-style-type: none"> • Create parametric profiles by sketching (page 181)
Parametric profile with variable cross sections	<ul style="list-style-type: none"> • Create parametric profiles with variable cross sections (page 206)

Create user-defined cross sections

User-defined cross sections can be used for creating fixed profiles. Define the needed cross sections before creating the profile.

Use any of the following methods to define a cross section:

- Define a cross section using polygon.
Use this method to create a cross section with fixed dimensions.
- Define a cross section using a plate.
Use this method if you have a contour plate in the model.
- Define a cross section using a DWG file.
Use this method if you have a .dwg file of the profile you want to define.

Define a cross section using polygon

Define a cross section by picking the shape of the cross section.

1. On the **File** menu, click **Catalogs --> Define profiles --> Define cross section using polygon**.
2. Define a cross section without or with inner contours.
 - To create a cross section with no inner contours:
 - a. Pick the corner points of the cross section to define the shape. Start at the bottom-right corner and pick the points counter clockwise.
 - b. Pick the start point and click the middle mouse button to close the shape.

- c. Pick the center point of the cross section.

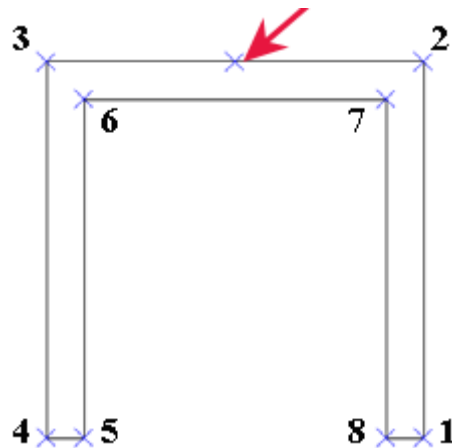

TIP To make it easier to define the shape, insert a reference model of the cross section in the model, and use the reference model as a basis for picking the cross section shape.

Alternatively, you can create a few construction lines or points in the model and use them to define the cross section shape.

If you do not have any actual points to pick, picking the center point of the cross section becomes difficult. This is because the cross section shape disappears after you have clicked the middle mouse button to close the shape.

- To create a cross section with inner contours:
 - a. Pick the corner points of the cross section to define the shape.
 - b. Pick the start point to close the shape.
 - c. Pick the corner points of the cross section inner contour.
 - d. Pick the start point to close the shape
 - e. Repeat until you have picked all inner contours.
 - f. Click the middle mouse button.

- g. Pick the center point of the cross section.

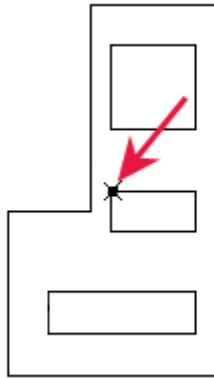

3. When the **User Profile Cross Section** dialog box appears, enter a name for the cross section.
4. Click **OK** to close the **User Profile Cross Section** dialog box.
5. Click **OK** in the **Save confirmation** dialog box to save the changes.

You can then use this cross section when you add a new profile to the profile catalog. The **Profile type** will be **User-defined, fixed**.

Define a cross section using a plate

You can define a cross section using a contour plate.

1. Create a contour plate that includes all the chamfers.
2. On the **File** menu, click **Catalogs --> Define profiles --> Define cross section using plate**.

The **Profile Cross-Section from Plate (10)** dialog box appears.

3. On the **Parameters** tab, enter a name in the **Section name** and **Profile name** boxes.

Other properties are optional.

4. Click **OK**.
5. Select the contour plate.

Tekla Structures creates the cross section with the shape of the contour plate.

You can then use this cross section when you add a new profile to the profile catalog. The **Profile type** will be **User-defined, fixed**.

Properties: Profile cross-section from plate (10)

Use the **Parameters** tab to define the profile properties in the **Profile cross-section from plate (10)** component.

Option	Description
Section name	Name of the cross section shown in the Modify Profile Catalog dialog box. If you leave this box empty, no profile is created.
Profile name	Name of the profile shown in the Beam properties, and in the Modify Profile Catalog dialog box. If you leave this box empty, no profile is created.
Save to	The location of the profile catalog. Select one of the following options: <ul style="list-style-type: none"> • Model directory: The current model folder. • Global directory: ..\ProgramData\Trimble\Tekla Structures\ <version>\environments\ <environment>\profil • Do not save: Does not save the profile. This is useful for testing.
Min distance between points	The minimum distance between the corner points of the cross section. To create simpler drawings of complicated cross sections, increase this value.
Center point offset	The origin of the plate defines the location of the profile reference line. Enter an offset value to move the reference line, relative to the cross section.
Coordinate system	Select one of the following options: <ul style="list-style-type: none"> • Use local • Use global xy-plane
Mirroring	Select one of the following options: <ul style="list-style-type: none"> • Do not mirror • Mirror to x-direction • Mirror to y-direction • Mirror to x- and y-direction

Define a cross section using a DWG file

If a cross section is available in DWG format, you can import the cross section and add it as a DWG profile to the profile catalog.

Tekla Structures supports DWG files that have been created using version ACAD2012 or earlier.

Before you start defining a cross section using a DWG file:

- Save the outline of the cross section as a DWG file. Ensure that the DWG file only contains the outline of the profile.
- Make sure that the cross section is created as a closed polyline.
- Make sure that the outline consists of only one closed polyline. You cannot, for example, define holes to your cross section with this method. If you need holes or openings, use the polygon or the plate creation method.
- Remove hatching and unnecessary lines from the DWG file. Tekla Structures imports all the lines it finds in the DWG file.
- If there are blocks in the DWG file, they must be exploded.

1. Open a model.
2. On the **File** menu, click **Catalogs --> Define profiles --> Define cross section using DWG file**.

The **DWG Profile to Library (6)** dialog box appears.

3. On the **Parameters** tab, browse for the DWG file.
4. Define the cross section properties.
5. Click **OK**.
6. In the model, pick the start and the end points of the cross section to be imported.

Tekla Structures imports the cross section and places the profile reference line at the origin of the DWG file.

You can then use this cross section when you add a new profile to the profile catalog. The **Profile type** will be **User-defined, fixed**.

Properties: DWG Profile to Library (6)

Use the **Parameters** tab to define the profile properties in the **DWG profile to library (6)** component.

Option	Description
Input file	Browse for the DWG file to be imported.
Section name	Name of the cross section shown in the Modify Profile Catalog dialog box.

Option	Description
Profile name	Name of the profile shown in the Modify Profile Catalog dialog box.
Save to	<p>The location of the profile catalog.</p> <p>Select one of the following options:</p> <ul style="list-style-type: none"> • Model directory: The current model folder. • Global directory: ..\ProgramData\Trimble\Tekla Structures\ <version>\environments\ <environment>\profil • Do not save: Does not save the profile. This is useful for testing.
Min distance between points	<p>The minimum distance between the corner points of the cross section.</p> <p>To create simpler drawings of complicated cross sections, increase this value.</p>
Center point offset	<p>The origin of the plate defines the location of the profile reference line.</p> <p>Enter an offset value to move the reference line, relative to the cross section.</p>

Modify a user-defined cross section

You can modify cross sections that have been defined using a polygon, a plate, or a DWG file.

1. On the **File** menu, click **Catalogs --> Define profiles --> Edit Polygon Cross Section**.

The **Modify Cross Section** dialog box appears.

2. Select the cross section you want to modify.
3. Modify the cross section point properties.
 - **Number** refers to each point picked when the cross section was created, in numerical order. The first point picked is 1, the second 2, and so on.
 - **Chamfer** refers to the chamfer shape.

- **x:** and **y:** apply to the chamfer type. For example, if you want the chamfer to be equal on both sides of the angle, only enter a value for **x:**.

For an uneven chamfer, enter values for **x:** and **y:**.

4. Click **Update**.
5. Click **OK** to close the **Modify Cross Section** dialog box.
6. Click **OK** in the **Save confirmation** dialog box to save the changes.

TIP If you want to delete a cross section, select the cross section and click **Delete**.

Create fixed profiles

You can create new fixed profiles either from scratch or by copying an existing one. You can also convert a parametric profile into a fixed one.

Create a fixed profile

You can create fixed profiles with a single cross section or with multiple cross sections. Note that cross sections affect the total weight of the profile.

WARNING If you create a profile with multiple cross sections, create the cross sections with the same number of corner points and in the same order.

1. On the **File** menu, click **Catalogs** --> **Profile catalog** to open the **Modify Profile Catalog** dialog box.
2. Right-click anywhere in the profile tree and select **Add Profile**.
A new fixed profile with the name **PROFILE1** is created.
3. Change the profile name by entering a new name in the **Profile name** box.

The profile name must be in upper case letters, with no spaces. Tekla Structures automatically converts lower case letters to upper case letters.
4. In the **Profile type** list, select **User-defined, fixed**.
5. In the **Profile subtype** list, select the cross section you want to use.

If you have [created your own user-defined cross sections \(page 164\)](#), you can use one of them.
6. Under **Equivalent type**, select a profile type that matches the new cross section as closely as possible. This is important because some connections only work for certain types of profiles.

The equivalent type and the profile dimensions, such as height and width, affect which connections can be applied to the profile. An unsuitable equivalent type or missing dimension values may result in problems with connections.

7. Click **Update**.
8. Modify the dimension values.
Always enter values for the dimensions **Height h** and **Width b**, as these values affect how Tekla Structures displays the profiles. If the values are 0, the part is drawn as a line.
9. Under **Cross section**, define a relative location for each cross section:
 - a. In the **Number** list, select the number of the cross section.
 - b. In the **Relative location** box, enter the location of the cross section.
This value indicates the location of the cross section along the axis: 0.0 for the start end and 1.0 for the second end. If you only have a single cross section, select 1 for **Number** and enter 0.000 for **Relative location**.
 - c. Click **Update** after defining each cross section.
10. Click **Add** to add more cross sections, if needed.
11. If you want to use a different cross section in the profile, select a new one from the **Profile subtype** list.
12. If you want to remove a cross section, select the cross section from the **Number** list and click **Remove**.
13. Click **OK** to close the **Modify Profile Catalog** dialog box.
14. Click **OK** in the **Save confirmation** dialog box to save the changes.

Example

For a pitched profile, you need two cross sections with the same center point height. The **Relative location** value is 0.0 for the first cross section, 0.5 for the second cross section, and 1.0 for the third cross section.

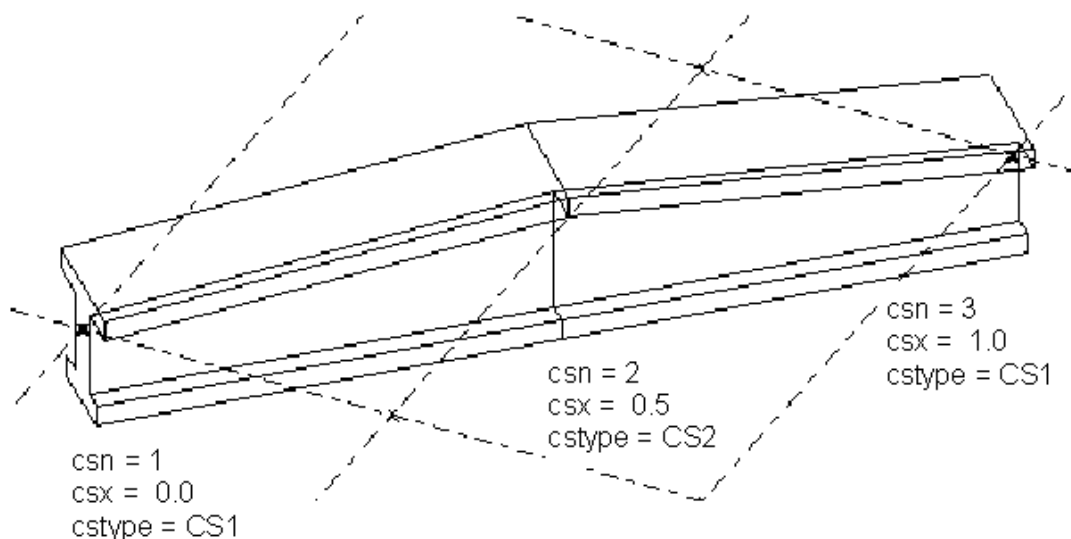

Create a fixed profile by copying

You can create new fixed profiles by modifying a copy of an existing, similar profile.

1. On the **File** menu, click **Catalogs** --> **Profile catalog** to open the **Modify Profile Catalog** dialog box.
2. Select a fixed profile that is similar to the one you wish to create.
3. Right-click and select **Copy Profile**.

A new profile with the name **<existing_profile_name COPY>** is created.

4. Change the profile name by entering a new name in the **Profile name** box.

The profile name must be in upper case letters, with no spaces. Tekla Structures automatically converts lower case letters to upper case letters.

5. Modify the profile properties on the **General**, **Analysis**, and **User attributes** tabs.

WARNING Under **Equivalent type**, select a profile type that matches the new cross section as closely as possible. This is important because some connections only work for certain types of profiles.

Always enter values for the dimensions **Height h** and **Width b**, as these values affect how Tekla Structures displays the profiles. If the values are 0, the part is drawn as a line.

The equivalent type and the profile dimensions, such as height and width, affect which connections can be applied to the profile. An unsuitable equivalent type or missing dimension values may result in problems with connections.

6. Click **Update**.
7. Click **OK** to close the **Modify Profile Catalog** dialog box.
8. Click **OK** in the **Save confirmation** dialog box to save the changes.

Create a fixed profile based on a parametric profile

1. On the **File** menu, click **Catalogs** --> **Profile catalog** to open the **Modify Profile Catalog** dialog box.
2. Select a parametric profile from the list.
3. Right-click and select **Add Profile**.

A new standard fixed profile is created, and it has the profile values of the parametric profile.

Modify a fixed profile

If necessary, you can modify existing fixed profiles using the profile catalog. Note that the fixed profiles conform to industry standards, and you should not modify them unless you are an administrator.

1. On the **File** menu, click **Catalogs --> Profile catalog** to open the **Modify Profile Catalog** dialog box.
2. Select a fixed profile  in the tree and modify its properties.
 - The **General** tab contains information on profile types and dimensions.
 - The **Analysis** tab contains information on the properties used in structural analysis. The structure can be analyzed with different analysis software.
 - The **User attributes** tab is for viewing or entering user attributes for profiles.
3. When you have finished modifying the profile, click **Update**.
4. Click **OK** to close the **Modify Profile Catalog** dialog box.

Tekla Structures asks if you want to save the changes to the model folder.
5. Click **OK** in the **Save confirmation** dialog box to save the changes.

Create parametric profiles using .clb files

You can create new parametric profiles using .clb files.

Follow the example workflow below to create a parametric profile with .clb files.

How the .clb, components.clb and profitab.inp files work together

When you create new parametric profiles using this method, you need the following three files:

- **.clb**

This file contains the cross section definitions. Create a new .clb file in the `..\ProgramData\Trimble\Tekla Structures\<version>\environments\common\inp` folder for each parametric profile you define.
- **components.clb**

This file contains a list of all .clb files that contain cross section definitions. When you create a new .clb file, you need to add its file name to the `components.clb` file located in the `..\ProgramData\Trimble\Tekla Structures\<version>\environments\common\inp` folder.
- **profitab.inp**

This file is the link between the .clb files and the profile catalog. This file contains a list of all parametric profiles available in Tekla Structures. The file controls how the parametric profiles are displayed in the **Modify Profile Catalog** dialog box. When you want to take a new parametric profile into use, you must add the needed profile definitions, such as the profile type, prefix and the unit of measurement, to the profitab.inp file. The profitab.inp file is located under the environment folder in ..\ProgramData\Trimble\Tekla Structures\

Tekla Structures searches for the profitab.inp file in the standard search order and then from the folder indicated by the advanced option XS_PROFDB.

Define the shape and point coordinates of the profile

Start by defining the shape and point coordinates of the new profile.

1. Design the profile on a paper.
 - a. Draw the cross section outline.
 - b. Add the needed corner points.
 - c. Add the needed dimensions.
 - d. Place the y-z coordinate axis center point to the middle of the cross section.

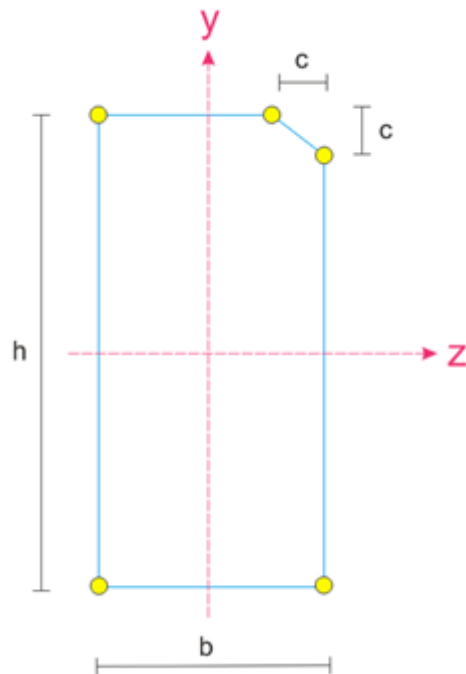

2. Define the y and z coordinate directions. For example:

- positive y axis: up
- negative y axis: down
- positive z axis: on the right
- negative z axis: on the left

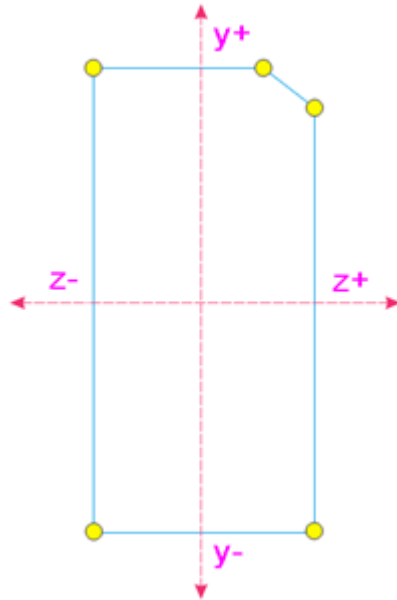

3. Define the y and z vectors. For example:
- y_1, y_2, y_3
 - z_1, z_2, z_3

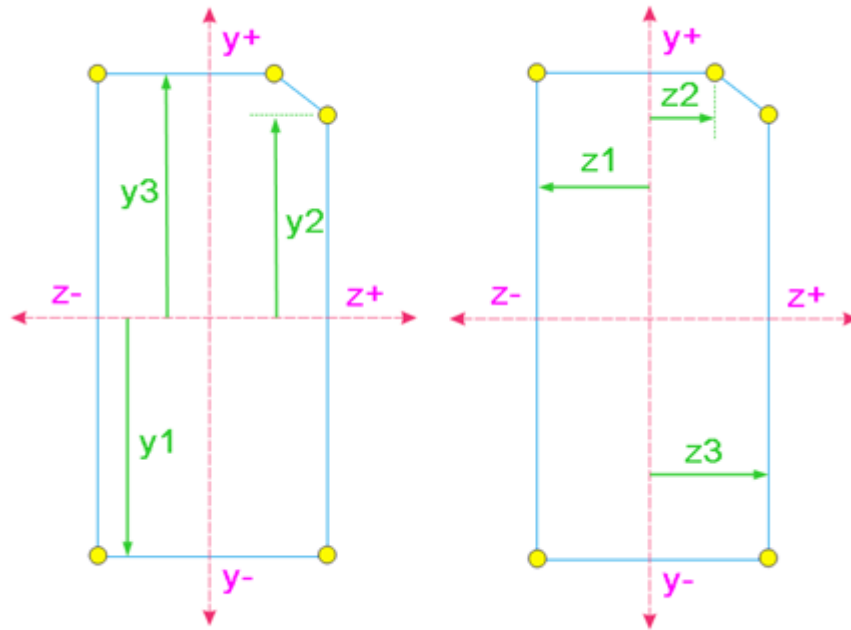

4. Make coordinate pairs to the points.

Assign y, z vector pairs to each point. Start from the lower right corner and define the points in the counter clockwise order. For example:

- point 1: $y_1 z_3$
- point 2: $y_2 z_3$
- point 3: $y_3 z_2$
- point 4: $y_3 z_1$
- point 5: $y_1 z_1$

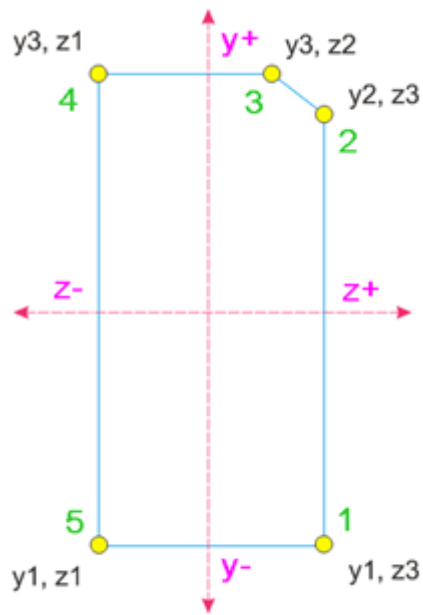

Create the .clb file

After defining the shape and point coordinates of the profile, you can continue by creating the actual .clb file.

1. Create a new .clb file using any standard text editor, for example Microsoft Notepad.
2. Define a library name that will be used in the `profitab.inp` file for this profile.

For example:

```
library_id "1Gen"
```

3. Define a cross section name that will be used in the `profitab.inp` file for this profile.

For example:

```
Section_type
{
name "RectChamfer"
```

4. Define the dimensions of the cross section.

For example:

```
base_attribute
{
  name "h"
  description "albl_Height"
  type dimension
  default 1000
}
```

5. Define the coordinates of the profile.

The coordinates must be the same as the y and z vectors that you defined earlier. Define the default values. For example:

```
expression
{
  name "y1"
  type y
  default -400
  formula -h/2
}
```

6. Define the geometry of one or several faces of the profile.

For example:

```
geometry
{
  name "default"
  face
  {
    index 0
    point 0 y1 z3
    point 0 y2 z4
    point 0 y3 z4
    point 0 y4 z3
    point 0 y4 z2
    point 0 y3 z1
    point 0 y2 z1
    point 0 y1 z1
  }
  face
  {
    index 1
    point 1 y5 z7
    point 1 y6 z8
    point 1 y7 z8
    point 1 y8 z7
    point 1 y8 z6
    point 1 y7 z5
    point 1 y6 z5
    point 1 y5 z6
  }
}
```

NOTE The index number refers to the point number: 0=start point of the beam, 1=end point of the beam.

7. Save the `.clb` file in the `..\ProgramData\Trimble\Tekla Structures\<version>\environments\common\inp` folder.
8. Open the `components.clb` file.
9. Add your profile definition to the `components.clb` file by adding the following line:

```
Include  
"new_file_name.clb" // give comment
```

10. Save the `components.clb` file.

Add profile definitions to the `profitab.inp` file

Before taking the new parametric profile into use, you must add the needed profile definitions to the `profitab.inp` file.

1. Find the `profitab.inp` file, located under the environment folder in `..\ProgramData\Trimble\Tekla Structures\<version>\environments\<environment>\`.
2. Copy the `profitab.inp` file to a model, project or firm folder.
3. Open the file in the new location using a standard text editor, such as Microsoft Notepad.
4. Under a suitable category, add a new line for the profile definition.

Use the following syntax:

```
Prefix  
! Type ! SO ! Z ! MI ! MA ! G3-NAME ! Z3-NAME !
```

5. Save the file.

The profile is now available in the profile catalog. You may have to restart Tekla Structures for the change to take effect.

Example

An example of a profile definition:

```
PNL_A  
! USER ! 0 ! ! 2 ! 3 !1Gen.RectChamfer !h*b-[c]
```

Properties used in `profitab.inp`

Use the following properties when you define new parametric profiles using the `profitab.inp` file:

Property	Description
Prefix	<p>Prefix of the parametric profile. The prefix is shown in the profile catalog.</p> <p>For example, PNL_A.</p>
Type	<p>Type of the parametric profile.</p> <p>The profile types are/include the following:</p> <p>I, L, Z, U, PL, D, PD, P, C, T, HK, HQ, ZZ, CC, CW, CU, EB, BF, SPD, EC, ED, EE, EF, EZ, EW, 102, 103, 104, 105, 106, USER</p> <p>For example, in the default environment, parametric profiles with prefixes PD, EPD, CHS, CFCHS, O, Ø, and TUBE all group under the type PD, and appear under Circular hollow sections in the profile catalog.</p>
SO	<p>Sorting order. The options are:</p> <ul style="list-style-type: none"> • -1: Decreasing sorting order • +1: Increasing sorting order • 0: No sorting order • -2: Name increasing, value decreasing • +2: Value increasing, name decreasing <p>For example, if your profile is PLT200*10 or PLT10*200 and the sorting order is +2, the result in the output (such as a report) for both cases is PLT200*10. If the sorting order is -2, the result for both cases is PLT10*200.</p>
Z	<p>Unit of measurement. The options are:</p> <ul style="list-style-type: none"> • 0: millimeters • 1: inches • 2: feet • 3: centimeters • 4: meters

Property	Description
MI	Minimum number of parameters you can use with the parametric profile. For example, the rectangular hollow section SHS has the following Profile subtypes: h*t, h*b*t, h1*b1-h2*b2*t . If you define SHS with a minimum of two and a maximum of two parameters, you will only have the option h*t available in the Select Profile dialog box.
MA	Maximum number of parameters you can use with the parametric profile.
G3-NAME	Refers to a cross section file (.clb file). Can be a combination of a library id and the name of a cross section, separated by a full stop. For example, 1Gen.RectChamfer.
Z3-NAME	Defines how the profile parameters relate to the parameters in the cross section file. Parameters in the order of appearance in the .clb file, optional parameters in square brackets. For example, h*b-[c]. Can also be the name of the detailing component.

Create parametric profiles by sketching

You can create parametric user-defined profiles by sketching. You can change the dimensions of parametric profiles each time you use them in a model.

- Use the cross section sketch editor to create and modify sketched profiles.
- The **Sketch Browser** shows the objects of a sketched profile.
- Use the **Variables** dialog box to define the properties of a sketched profile.

Open the sketch editor

1. Open a Tekla Structures model.
2. On the **File** menu, click **Editors** --> **Define cross section in sketch editor**.

Tekla Structures opens the sketch editor, the **Sketch Browser**, and the **Variables** dialog box.

When you first open the sketch editor, the view is empty. The grid coordinates and labels that you see in the sketch editor depend on the grid properties of your actual Tekla Structures model.

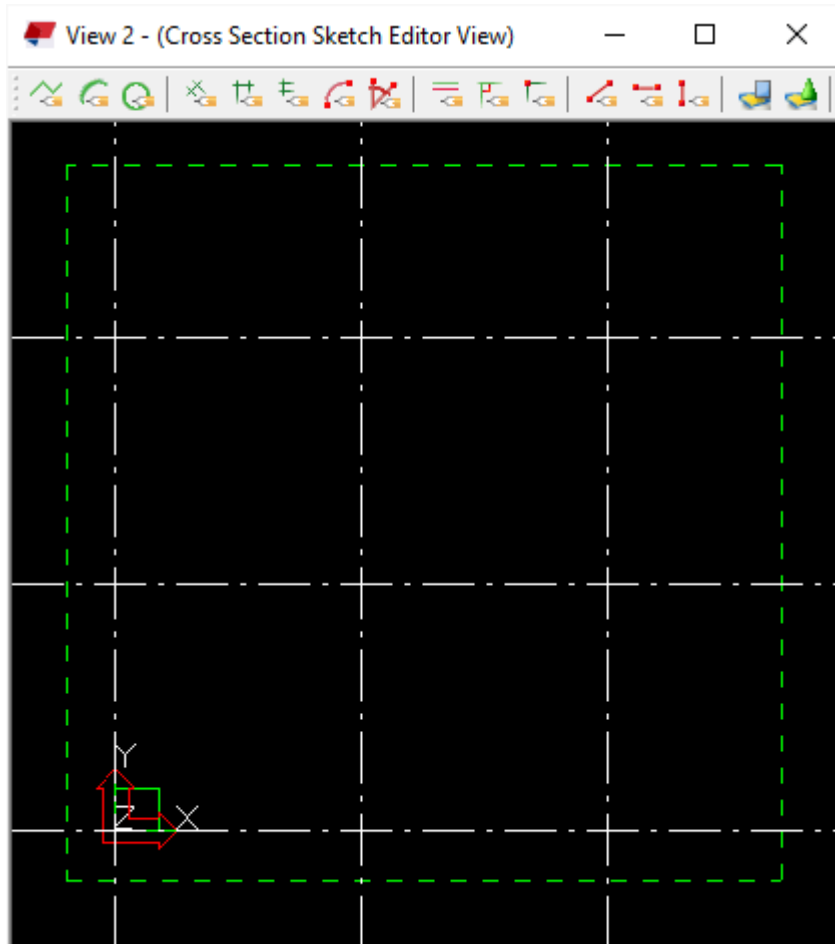

Sketch Browser

The **Sketch Browser** shows the objects (lines, arcs, circles, constraints, dimensions, and chamfers) of a sketched profile in a hierarchical, tree-like structure. The **Sketch Browser** automatically opens when you open the sketch editor.

When you click an object in the sketch editor, Tekla Structures highlights the object in the **Sketch Browser**, and vice versa.

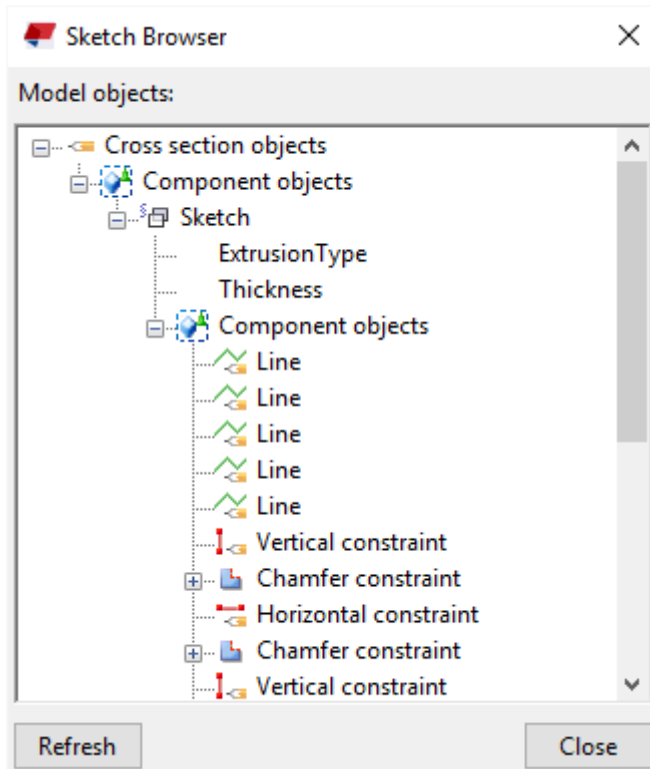

The **Sketch Browser** displays the following information about a sketched profile:

- Extrusion type (0, 1, or 2) and thickness of the sketched profile
- Lines, arcs, and circles
- Constraints
- Distances and dimensions and their values
- Chamfers and their type (0=**None**, 1=**Line** ... 7=**Line and arc**) and dimensions.

Variables in sketched profiles

Use the **Variables** dialog box to define the properties of a sketched profile. Variables can define fixed properties, or they can include formulas, so that Tekla Structures calculates the property value each time you use the profile in a model.

The **Variables** dialog box automatically opens when you open the sketch editor.

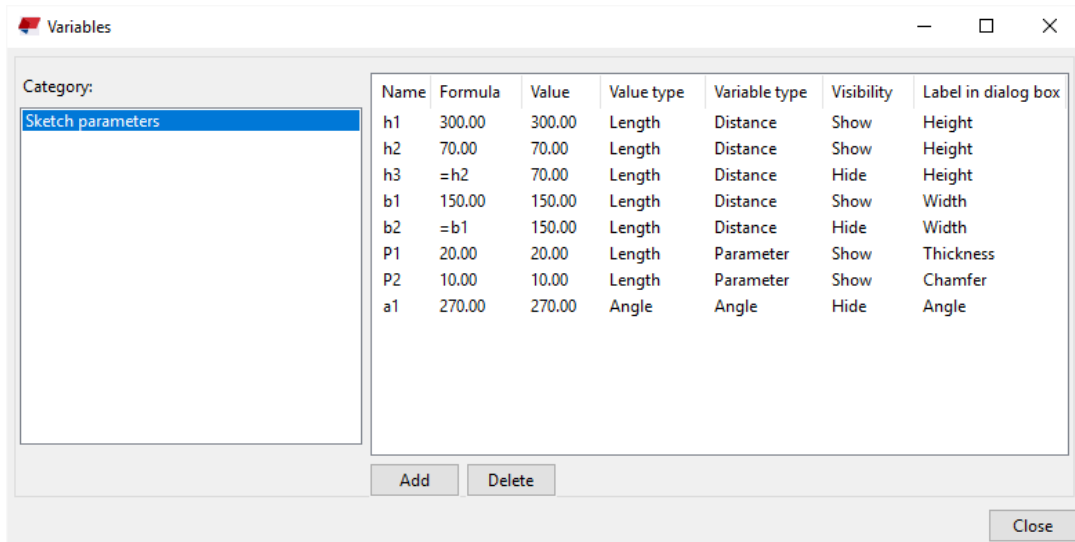

NOTE The **Variables** dialog box functions the same way as the corresponding dialog box in the custom component editor. For more information on how to use variables, see [Add variables to a custom component](#).

Sketch the outline of a profile

When you create a new sketched profile, start by sketching the outline and the holes of the profile using lines, arcs, and circles.

Ensure that you create a closed shape, unless you are creating a profile of a consistent thickness, such as a cold-rolled profile.

Sketch a polyline

You can create line segments in the sketch editor by picking points. Tekla Structures automatically creates coincident constraints between the line segments and displays a chamfer symbol where line segments meet.

1. [Open the sketch editor. \(page 181\)](#)
2. Click the **Sketch polyline** button: .
3. Pick points to create each line segment.
4. Click the middle mouse button to create the polyline.

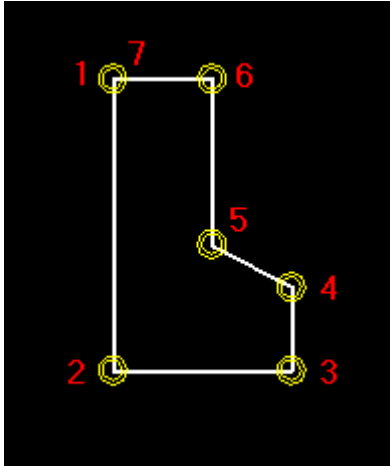

Sketch an arc

You can create an arc in the sketch editor by picking three points.

1. [Open the sketch editor. \(page 181\)](#)
2. Click the **Sketch arc** button: .
3. Pick three points to define the arc.

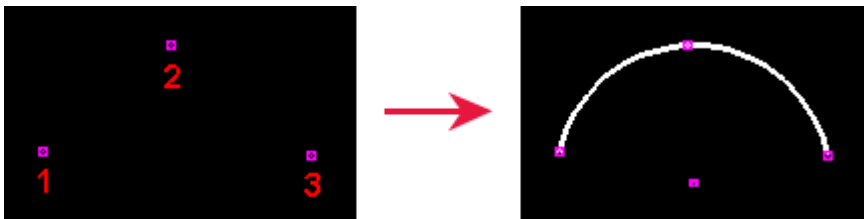

TIP You can use the advanced option `XS_CS_CHAMFER_DIVIDE_ANGLE` to define the smoothness of the arc.

Sketch a circle

You can create a circle in the sketch editor by picking two points.

1. [Open the sketch editor. \(page 181\)](#)
2. Click the **Sketch circle** button: .
3. Pick a point to indicate the center of the circle **(1)**.
4. Pick a point to indicate the radius of the circle **(2)**.

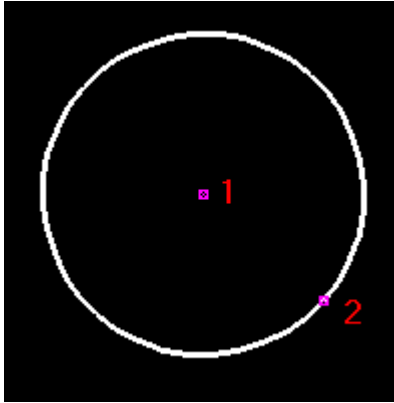

Refine the shape of a sketched profile by adding a constraint

After you have sketched the outline of a profile, use *constraints* to refine your sketch and lock the shape. For example, you can straighten lines, create 90 degree angles, force lines to meet, close the shape, and add chamfers in corners.

To straighten the entire profile, use horizontal and vertical constraints in conjunction with other constraints. Although the shape is locked, you can still rotate the profile in the model.

Add a parallel constraint

You can force two lines in a sketched profile to be parallel to each other.

Before you start, [sketch the outline of the profile in the sketch editor.](#) (page 184)

1. Click the **Parallel constraint** button: .
2. Select a line in the sketch **(1)**.
3. Select another line in the sketch **(2)**.

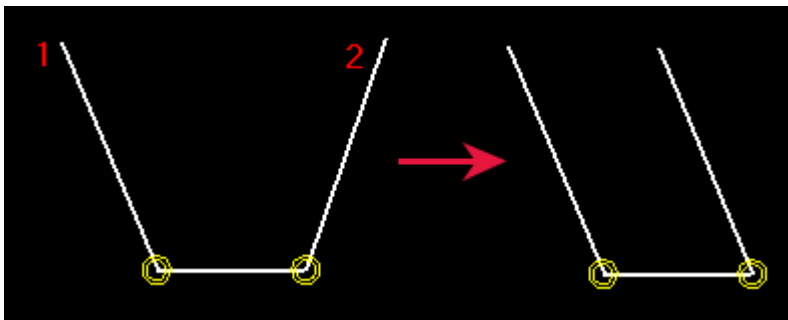

Add a perpendicular constraint

You can force a line in a sketched profile to be at a 90 degree angle to another line you select. The lines do not have to intersect.

Before you start, [sketch the outline of the profile in the sketch editor.](#)
(page 184)

1. Click the **Perpendicular constraint** button: .
2. Select a line in the sketch **(1)**.
3. Select another line in the sketch **(2)**.

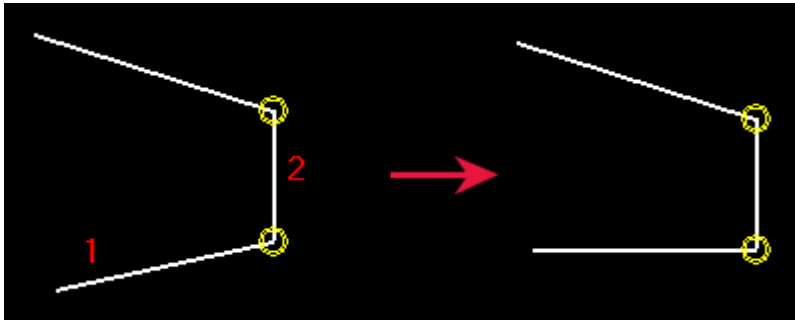



Add a coincident constraint

You can force two lines in a sketched profile to start or end at the same point, by extending or shortening one or both lines. The lines do not have to intersect.

NOTE Tekla Structures automatically creates coincident constraints

- where two lines meet.
- between line segments when you draw them with the **Sketch polyline** tool.
- between the start of the first line segment and the end of the last line segment in a shape, if they are within a certain distance of each other.

Before you start, [sketch the outline of the profile in the sketch editor.](#)
(page 184)

1. Ensure that the **Snap to end points**  snap switch is active.
2. Click the **Coincident constraint** button: .
3. Pick the end of the first line **(1)**.
4. Pick the end of the second line **(2)**.

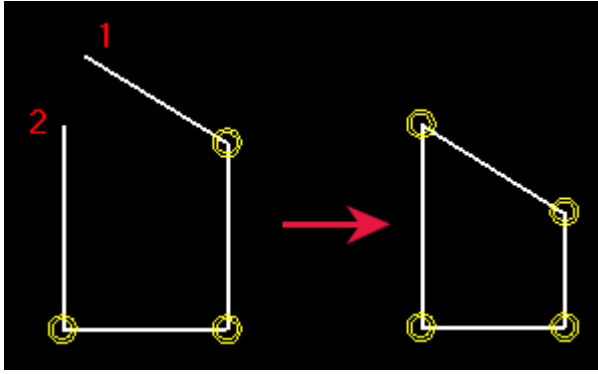

Add a fixed constraint

You can lock the position and angle of a line in a sketched profile so that other constraints do not affect it.

Before you start, [sketch the outline of the profile in the sketch editor.](#)
(page 184)

1. Click the **Fixed constraint** button: .
2. Select a line in the sketch.

Add a horizontal constraint

Use horizontal constraints to force a line in a sketched profile to be parallel to the local x axis. Tekla Structures automatically creates horizontal constraints when you create lines that are nearly horizontal.

Before you start, [sketch the outline of the profile in the sketch editor.](#)
(page 184)

1. Click the **Horizontal constraint** button: .
2. Select the lines you want to straighten (**1, 2**).

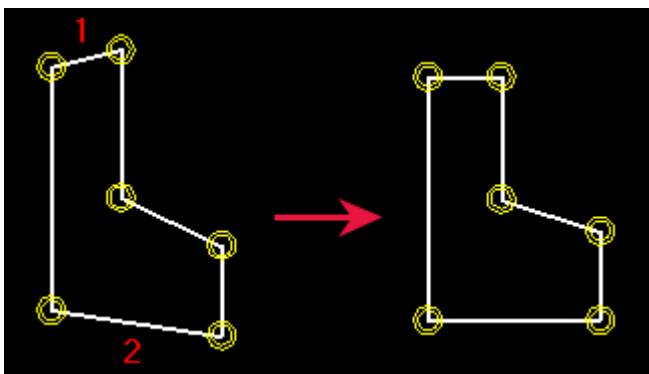

Add a vertical constraint

Use vertical constraints to force a line in a sketched profile to be parallel to the local y axis. Tekla Structures automatically creates vertical constraints when you create lines that are nearly vertical.

Before you start, [sketch the outline of the profile in the sketch editor.](#) (page 184)

1. Click the **Vertical constraint** button: 
2. Select the lines you want to straighten (**1, 2**).

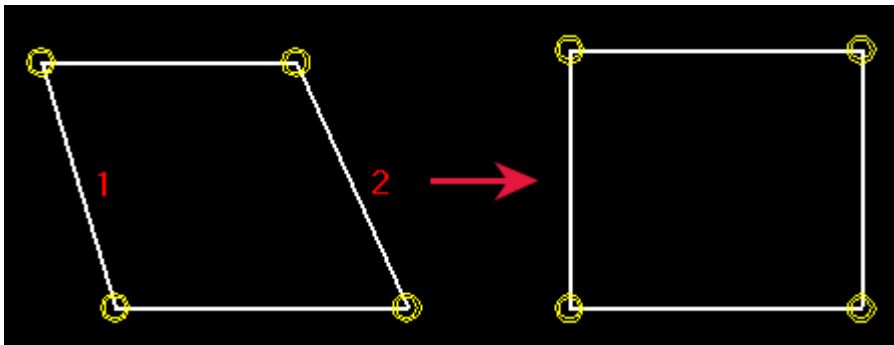

Delete a constraint

You can delete constraints from sketched profiles.

1. Click  to open the **Sketch Browser**.
2. Select the constraint you want to delete.
3. Right-click and select **Delete**.
4. Click **Refresh**.

Add dimensions to a sketched profile

After you have sketched a profile, use dimensions to make different distances in the profile parametric. You can use these dimensions to define the size of the profile when you use it in a model.

Tekla Structures also adds the dimensions you create to the list of variables that you can use in calculations.

NOTE Do not create too many dimensions in a sketch, or the dimensions will not be able to adjust when the values are changed.

In the following example, if you create the dimension marked in red, the dimension b1 will no longer work:

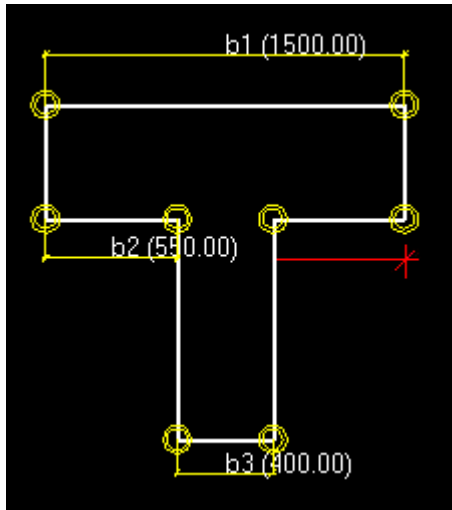

Add a radial dimension to a sketch

You can create a radial dimension for an arc or a circle in a sketched profile.

Before you start, [sketch the outline of the profile in the sketch editor.](#)
(page 184)

1. Click the **Sketch radial dimension** button: .
2. Select the arc or circle.

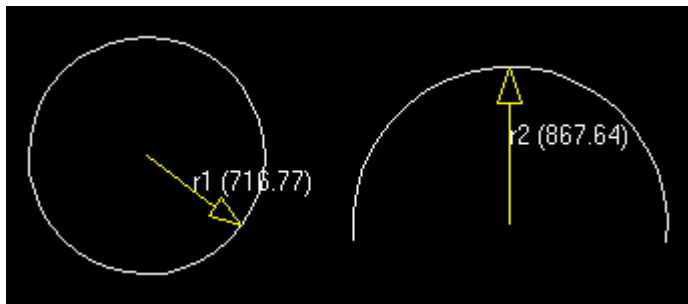

Add an angle dimension to a sketch

You can create an angle dimension between two lines in a sketched profile. The angle is calculated counter clockwise from the first line you select.

Before you start, [sketch the outline of the profile in the sketch editor.](#)
(page 184)

1. Click the **Sketch angle dimension** button: .
2. Select the first line **(1)**.
3. Select the second line **(2)**.

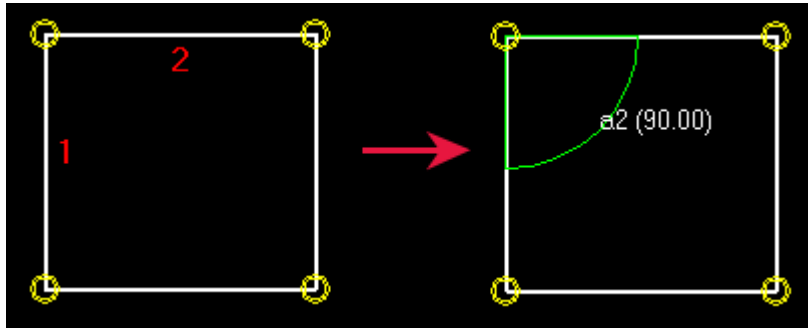

TIP If you are unable to see the angle symbol, scroll with the mouse wheel to zoom in.

Add a dimension between two points in a sketch

You can add a dimension to a sketched profile, between two points you pick.

Before you start, [sketch the outline of the profile in the sketch editor.](#)
(page 184)

1. Click the **Sketch free dimension** button: 
2. Pick a point to indicate the start point of the dimension **(1)**.
3. Pick a point to indicate the end point of the dimension **(2)**.
4. Pick a point to indicate the location of the dimension lines and text.

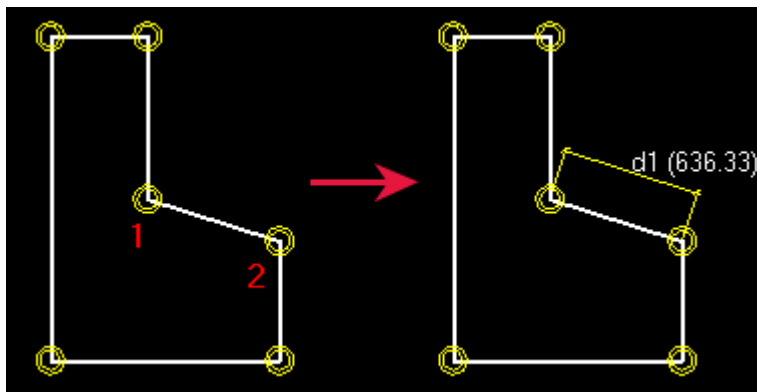

Add a horizontal dimension to a sketch

You can add a horizontal dimension to a sketched profile, between two points you pick.

Before you start, [sketch the outline of the profile in the sketch editor.](#)
(page 184)

1. Click the **Sketch horizontal dimension** button: 
2. Pick a point to indicate the start point of the dimension **(1)**.

- Pick a point to indicate the end point of the dimension **(2)**.
- Pick a point to indicate the location of the dimension lines and text.

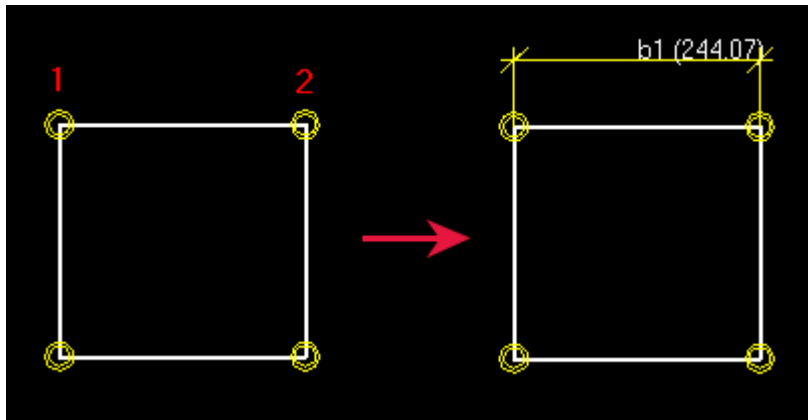

Add a vertical dimension to a sketch

You can add a vertical dimension to a sketched profile, between two points you pick.

Before you start, [sketch the outline of the profile in the sketch editor.](#)
(page 184)

- Click the **Sketch vertical dimension** button: .
- Pick a point to indicate the start point of the dimension **(1)**.
- Pick a point to indicate the end point of the dimension **(2)**.
- Pick a point to indicate the location of the dimension lines and text.

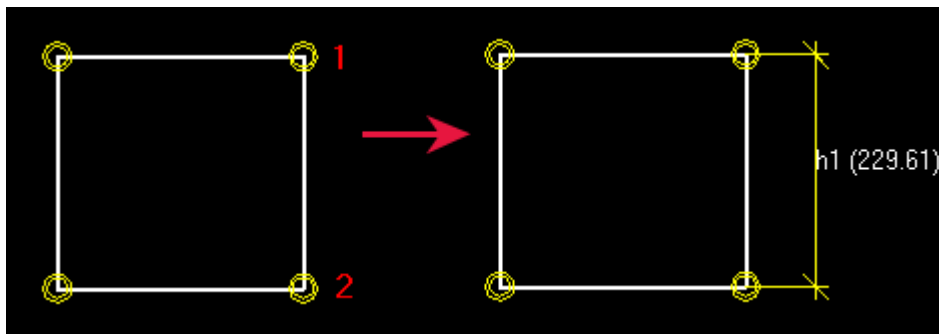

Delete a dimension from a sketch

When you want to delete a dimension from a sketch, you can do it in the sketch editor view, in the **Variables** dialog box, or in the **Sketch Browser**.

- Select the dimension you want to delete.
- Do one of the following:
 - In the sketch editor view or in the **Sketch Browser**, right-click and select **Delete**.

- In the **Variables** dialog box, click the **Delete** button.

Define positioning planes for a sketched profile

When you sketch a profile, you can define *positioning planes* for it. With positioning planes you can determine the planes Tekla Structures will use for positioning parts and components.

Part positioning planes

With *part positioning planes* you can determine how Tekla Structures positions parts that have a sketched profile. These planes are used for the **On plane** and **At depth** settings for parts, and also when placing custom components that are bound to boundary planes.

The part positioning planes are displayed in blue:

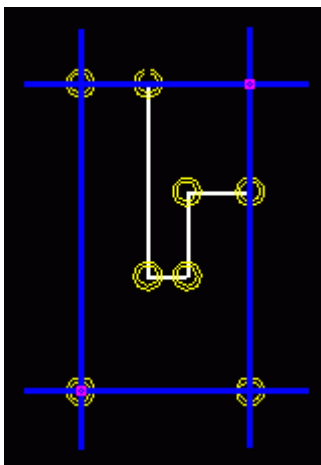

The **On plane** options **Left** and **Right** are set according to the vertical blue planes, and the **Middle** option is halfway between them.

The same principle applies to the **At depth** setting: the **Front** and **Behind** options are set according to the horizontal blue planes, and the **Middle** option is halfway between them.

▼ Position		
On plane	Middle ▼	0.00 mm
Rotation	Top ▼	
At depth	Middle ▼	0.00 mm

Example

You can define part positioning planes so that an asymmetric profile will be positioned according to its web only. In the following example, the **Middle** option is illustrated in gray dotted lines:

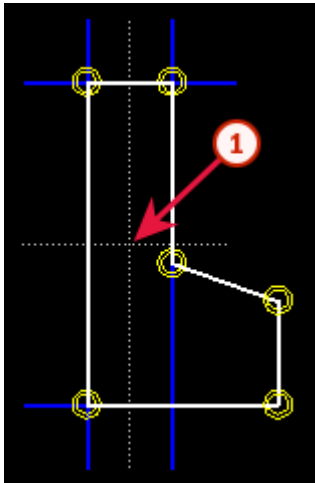

(1) Middle option

Connection positioning planes

With *connection positioning planes* you can determine how Tekla Structures positions components in relation to the component main part that has a sketched profile.

The connection positioning planes are displayed in green:

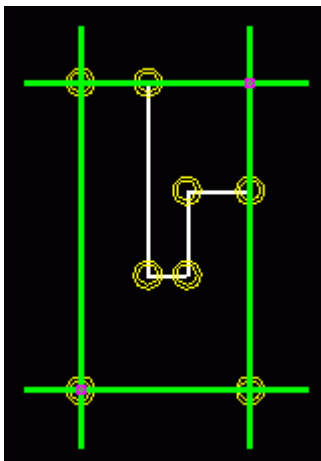

Example

The following image shows the default connection positioning planes of a double tee slab that was created as a sketched profile. The green line illustrates the default connection positioning planes.

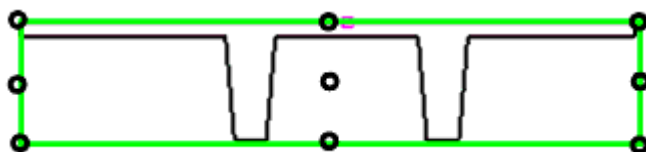

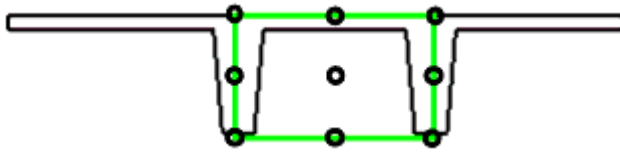

To place connections according to the location of the stems of the double tee, move the connection positioning planes as shown below.



Show and hide positioning planes

To show or hide the positioning planes, do one of the following:

To	Do this
Show or hide part positioning planes	Click  .
Show or hide connection positioning planes	Click  .

Move positioning planes

You can move the positioning planes by moving their handles. Note that if you move the handles away from the outmost corners of the sketched profile, you must bind them by adding a dimension to each handle. Otherwise the positioning will not function correctly in the model.

1. Click the positioning plane to display the handles.

The handles are displayed in pink. By default, the handles are at the outmost corners of the sketched profile. For example:

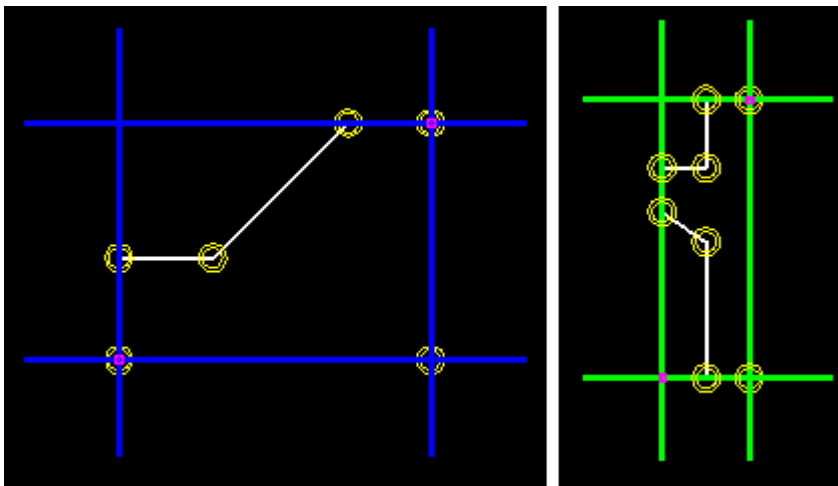

2. Click a handle to select it.

NOTE The same handle controls both the vertical and horizontal plane, so you can move them both at the same time.

3. Move the handle like any other object in Tekla Structures.
For example, right-click and select **Move**.
4. If the handle is not at the outmost corner of the profile, add a dimension between the handle and the corner.

Example

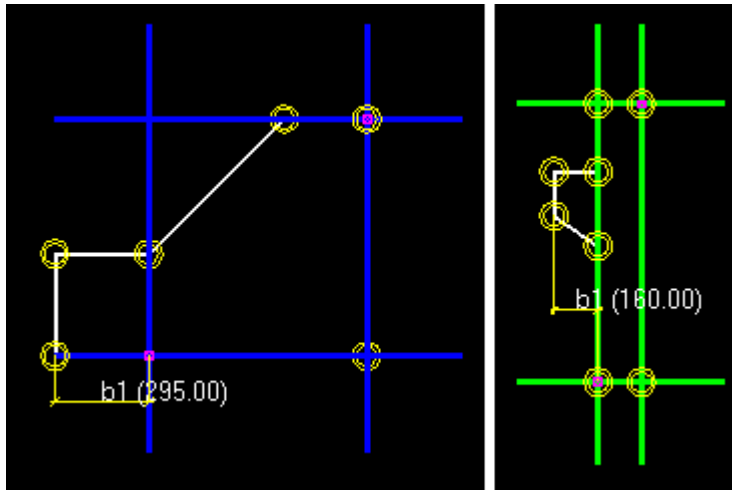

In the following examples, the left handle of the positioning plane has been bound by using a horizontal dimension (**b1**):



Revert to default positioning planes

You can revert back to the default positioning planes of a sketched profile if you have moved the planes.

To revert to the default positioning planes, do one of the following:

To	Do this
Revert to the default part positioning planes	<ol style="list-style-type: none"> 1. Click  to show the part positioning planes. 2. Select the part positioning planes. 3. Right-click and select Delete. 4. Click  again to check that the planes have reverted back to the default.
Revert to the default connection positioning planes	<ol style="list-style-type: none"> 1. Click  to show the connection positioning planes.

To	Do this
	<ol style="list-style-type: none"> <li data-bbox="850 271 1367 342">2. Select the connection positioning planes. <li data-bbox="850 353 1367 389">3. Right-click and select Delete. <li data-bbox="850 405 1367 553">4. Click  again to check that the planes have reverted back to the default.

Check a sketched profile

You can check that the constraints and dimensions in a sketched profile work correctly.

1. Double-click a dimension line to open the **Distance Properties** dialog box.
2. Change the **Value** box.
3. Click **Modify**.
Tekla Structures updates the profile in the sketch editor.
4. Check that the shape of the profile does not change and that the dimensions adjust correctly.
5. Click **Cancel** to close the **Distance Properties** dialog box.

See also

[Use sketched profiles in a model \(page 200\)](#)



Save a sketched profile

Tekla Structures saves the sketched profiles in the current model folder, in the `xslib.db1` file, which is a library file containing custom components and sketches. Sketched profiles are available in the **Others** section in the profile catalog.

NOTE Note the following limitations when naming sketched profiles:

- You cannot use the name of a fixed profile.
- You cannot include numbers, special characters, or blank spaces in the profile name.
- Lower case letters are automatically converted into upper case letters.

To save a sketched profile, do one of the following:

To	Do this
Save a new profile	<ol style="list-style-type: none"> 1. Click Save sketch . 2. Enter a name in the Prefix box, and then click OK.
Update an existing profile	<ol style="list-style-type: none"> 1. Click Save sketch . 2. Click Yes when prompted to update the existing cross section.
Save a copy of the profile under a different name	<ol style="list-style-type: none"> 1. Click Save sketch as . 2. Enter a new name in the Prefix box, and then click OK.

See also

[Import and export sketched profiles \(page 162\)](#)

Modify sketched profiles

You can modify existing sketched profiles, for example, by modifying chamfers or dimensions. You can also move corners or holes by moving the handles. The chamfers are moved automatically when you move the handles.



Modify a sketched cross section

-
- NOTE**
- You cannot change dimensions that have been calculated using formulas in the **Variables** dialog box.
 - Constraints may also prevent you from changing dimensions.
-

1. On the **File** menu, click **Catalogs** --> **Profile catalog** to open the **Modify Profile Catalog** dialog box.
2. Open the **Others** branch at the end of the profile tree.
3. Right-click a sketched profile, and then select **Edit profile** to open the profile in the sketch editor.
4. Double-click a sketch object to modify its properties.
The sketch objects you can modify appear in yellow.
5. Modify the properties and then click **Modify**.
6. Close the sketch object properties dialog box.
7. Click the **Save sketch as** icon  to save the changes.

Modify chamfers in a sketch

You can change the shape and dimensions of chamfers in a sketched profile. For example, you can create rounded profile corners.

1. Double-click a chamfer symbol  in the sketch editor.
2. In the **Chamfer Properties** dialog box, change the shape and dimensions of the chamfer.
3. Click **Modify**.
4. Click **OK** to close the dialog box.
5. Click the **Save sketch as** icon  to save the changes.

Set the sketch thickness

If you have sketched an open shape, such as a cold-rolled section, you must define the extrusion type and thickness of the sketch in the **Sketch Browser**. The thickness can be either fixed or parametric.

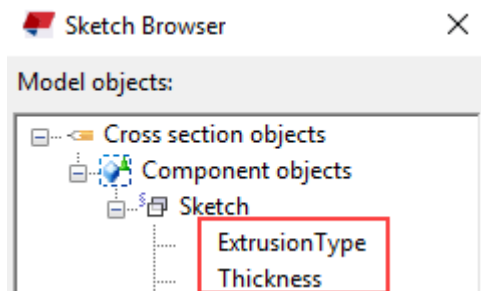

1. In the sketch editor, [sketch an open polyline \(page 184\)](#).
2. Do one of the following:
 - To set a fixed thickness:
 - a. In the **Sketch Browser**, right-click **Thickness** and select **Add Equation**.
 - b. Enter the value of the thickness after =.
 - To define a parametric thickness:
 - a. In the **Variables** dialog box, add a new parameter variable for **Length** (for example, P1).
 - b. In the **Formula** column, define the default value for the parameter variable.
 - c. In the **Sketch Browser**, right-click **Thickness** and select **Add Equation**.
 - d. Enter the name of the parameter variable (for example, P1) after =.
3. To define the extrusion type:

- a. In the **Sketch Browser**, right-click **ExtrusionType** and select **Add Equation**.
 - b. Enter the extrusion type number (0, 1, or 2) after =.
4. Click the **Save sketch as** icon  to save the changes.

Extrusion types

The extrusion type defines how a sketched profile of a consistent thickness is extruded. When you change the thickness, the profile grows inwards, outwards, or symmetrically in both directions, depending on the extrusion type. You must define the extrusion type for sketches that consist of an open polyline.

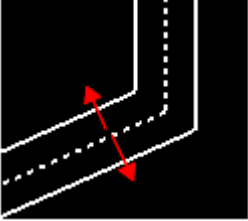
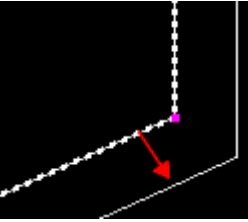
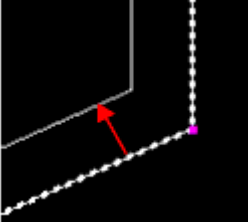
Type	Description	Image
0	The sketch is extruded symmetrically to the outside and inside of the polyline. (Default)	
1	The sketch is extruded to the outside of the polyline.	
2	The sketch is extruded to the inside of the polyline.	

Use sketched profiles in a model

Once you have created a sketched profile and saved it, you are ready to use it in the model. If you have applied constraints correctly, the shape of the profile will be maintained when you change its dimensions.

To use a sketched profile for a new part in a model:

1. Open the part properties in the property pane.

For example, to open the beam properties, on the **Steel** tab, hold down

Shift and click .

2. Click the ... button next to the **Profile** box.
The **Select Profile** dialog box appears.
3. Open the **Others** branch at the end of the profile tree.
4. Select a sketched profile.
5. If the profile is parametric, you can define its dimensions in the **Value** column on the **General** tab.
6. Click **OK** to close the **Select Profile** dialog box.
7. Pick points to place the part in the model.

See also

[Create an image of a profile \(page 209\)](#)

Example: Create a symmetric C-shaped profile by sketching

This example shows how to create a sketched profile using variables.

After completing the tasks, you will have a symmetric C-shaped profile with the dimensions $b1 = b2$ and $h2 = h3$. When you use the profile in the model, you can change the following dimensions:

- Width ($b1$)
- Total height ($h1$)
- Height ($h2$)
- Thickness ($P1$)
- Chamfers ($P2$)

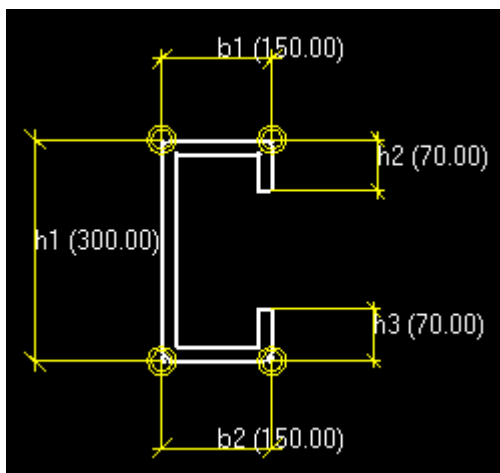



Example: Sketch a C-shaped profile

Start by sketching the outline of the profile.

1. Open the sketch editor.
2. Use the **Sketch polyline** command to create a rough C-shaped profile.

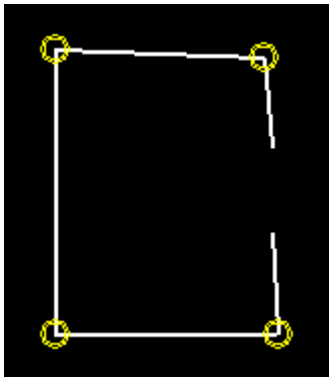
At this stage, the profile does not have to be symmetric or have the right dimensions.



3. Straighten the lines using the **Add horizontal constraint**  and **Add vertical constraint**  commands.

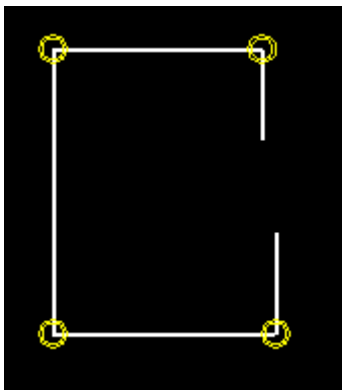

4. Save the profile and name it CSHAPE.

Example: Add dimensions to the sketched profile

After sketching the outline of the profile, you can continue by adding dimensions.

1. Use the **Sketch horizontal dimension**  command to create the distances b1 and b2.

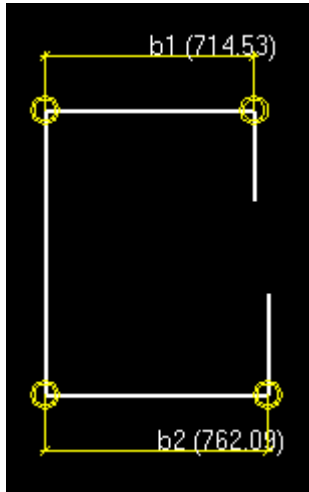

2. Use the **Sketch vertical dimension**  command to create the distances h1, h2, and h3.

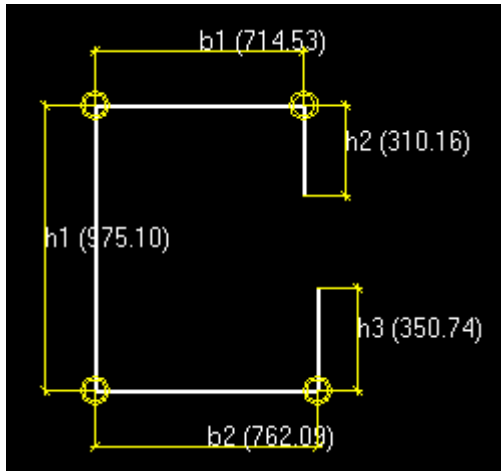

3. In the **Variables** dialog box, enter the following values for the distances:

Name	Formula	Value	Value type	Variable type	Visibility	Label in dialog box
b1	150.00	150.00	Length	Distance	Show	Width
b2	=b1	150.00	Length	Distance	Hide	Width
h1	300.00	300.00	Length	Distance	Show	Height
h2	70.00	70.00	Length	Distance	Show	Height
h3	=h2	70.00	Length	Distance	Hide	Height

4. Ensure that **Visibility** is set to **Show** for the distances b1, h1, and h2.
 5. Save the sketched profile.

Example: Set the sketch thickness

After adding dimensions to the sketched profile, you can continue by defining the thickness of the sketch.

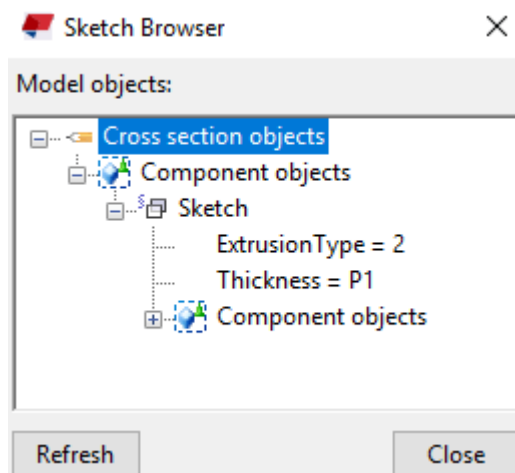

1. In the **Variables** dialog box, do the following:
 - a. Click **Add** to add a parameter variable P1.
 - b. In the **Formula** column, enter 20.00.
 - c. In the **Visibility** column, select **Show**.
 - d. In the **Label in dialog box** column, enter `Thickness`.
2. In the **Sketch Browser**, set the thickness using the parameter variable P1.
 - a. Right-click **Thickness**, select **Add Equation**, and then enter `=P1`.
 - b. Right-click **ExtrusionType**, select **Add Equation**, and then enter `=2` to get the sketch extruded to the inside of the polyline.



3. Save the sketched profile.

Example: Modify the chamfers of the sketched profile

After setting the thickness of the sketch, you can continue by modifying the chamfers of the sketched profile.

1. In the sketch editor, do the following:
 - a. Double-click a chamfer symbol .
 - b. In the **Chamfer properties** dialog box, change the chamfer type to **Line** , and then click **Modify**.
 - c. Repeat steps 1a–b for all the chamfers.
2. In the **Variables** dialog box, do the following:
 - a. Click **Add** to add a parameter variable P2.

- b. In the **Formula** box, enter 10.00.
 - c. In the **Visibility** box, select **Show**.
 - d. In the **Label in dialog box** box, enter `Chamfer`.
3. In the **Sketch Browser**, do the following:
 - a. Double-click **Chamfer constraint** to open the chamfer properties.
 - b. Right-click **Chamfer X**, select **Add Equation**, and then enter `=P2`.
 - c. Enter the same value for **Chamfer Y**.
 - d. Repeat steps 4a–c for all the chamfers.

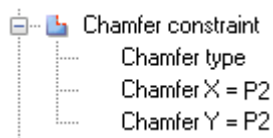

4. Save the sketched profile.

Example: Use the sketched profile in a model

Your sketched profile is now completed and you can use it in a model.

1. Double-click a part to open the part properties in the property pane.
2. Click the ... button next to the **Profile** box.

The **Select Profile** dialog box appears.

3. Open the **Others** branch at the end of the profile tree, and select the **CSHAPE** profile.
4. If needed, modify the dimensions of the profile on the **General** tab.

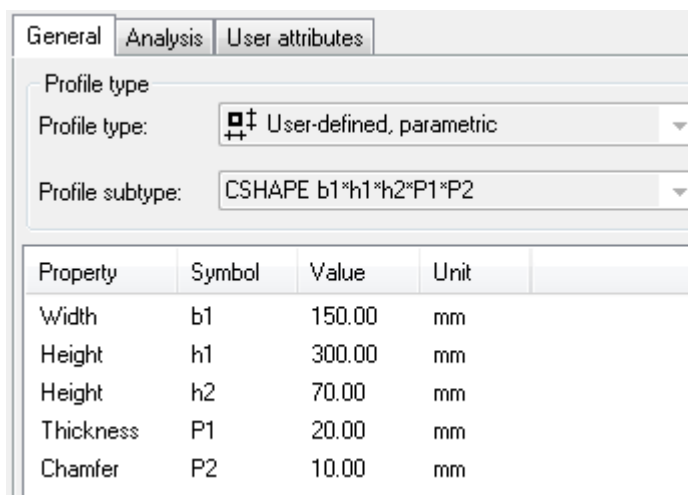

5. Click **OK** to apply the changes.
6. Pick points to place the part in the model.



Create parametric profiles with variable cross sections

You can create parametric user-defined profiles with variable cross sections using the **Profile Editor**. You can use a profile with variable cross sections like any other parametric profile.

You can

- use a cross section with different dimensions at different locations in a profile
- modify the variables of the cross sections and the profile
- save the profile and use it as a parametric profile through the profile catalog
- import and export variable cross section profiles

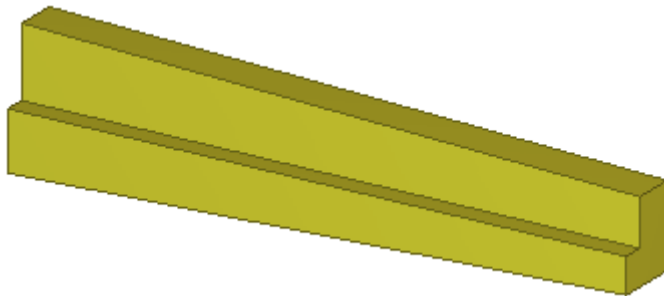

NOTE When you use this method, only the dimensions of a variable cross section can vary, not the actual shape of the cross section. If you want to use several different cross section shapes in the profile, [create a fixed profile \(page 170\)](#) with multiple cross sections instead.

Create a profile with variable cross sections

Before you start:

- [Create a sketched profile \(page 181\)](#) using the sketch editor.

- In the **Variables** dialog box in the sketch editor, set **Visibility** to **Show** for the dimensions that you want to change when using the profile in a model.

1. On the **File menu**, click **Catalogs --> Define properties --> Define profile with variable cross section**.

The **Define Profile with Variable Cross Section** dialog box opens.

2. Select the sketch you want to use as the start and end cross section of the profile.
3. Click **OK**.

The **Profile Editor** and the **Profile preview** view appear.

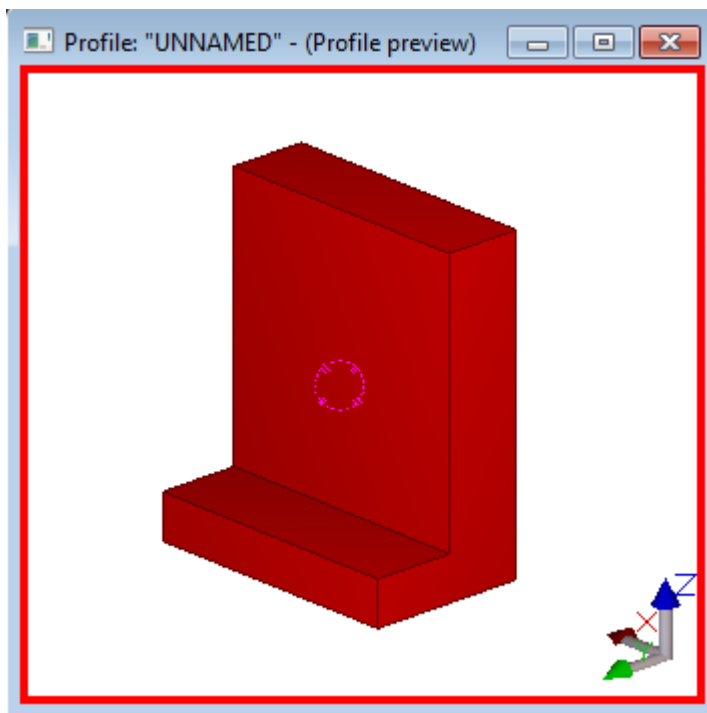

4. Under **Cross sections of the profile**, add cross sections or remove selected cross sections by clicking **Add** or **Remove**.

When you click **Add**, Tekla Structures adds a new cross section at the end of the profile, at the location 1.0., and moves the existing cross sections towards the start of the profile. By default, cross sections are located at 0.1 intervals in the profile.

5. Under **Cross section variables**, define the following:

- The relative location of each cross section in the profile.
Use the `*.Location` variables. For example, `start=0.00`, `middle=0.5`, `end=1.00`.
- How the cross sections are aligned in the horizontal and vertical direction.
Use the `*.HorPos` and `*.VerPos` variables.

- How much the cross sections are offset from the alignment.
Use the `*.HorOffset` and `*.VerOffset` variables.

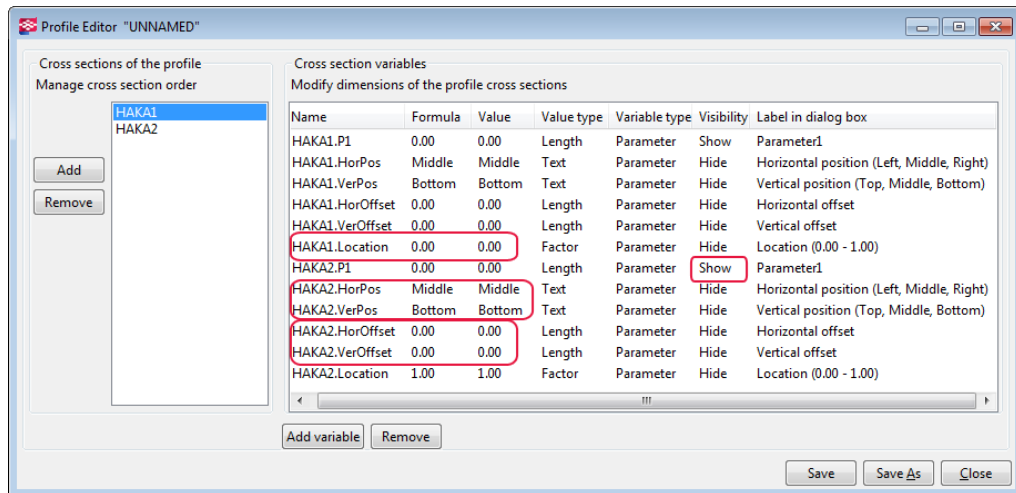

6. If you have added new cross sections, check that they do not overlap any existing cross sections.
7. Set **Visibility** to **Show** for the dimensions that you want to change when using the profile in a model.
8. If you want to use parameter variables and equations to define the cross section dimension, click **Add variable** and define the variable values.
9. Save the profile.
 - a. Click **Save**.
 - b. In the **Save profile as** dialog box, enter a unique name for the profile.

You cannot include numbers in the profile name, or use the name of a standard profile.

- c. Click **OK**.
Tekla Structures saves the profile in the current model folder.

Modify a profile with variable cross sections

1. On the **File** menu, click **Catalogs** --> **Profile catalog** to open the **Modify Profile Catalog** dialog box.
2. Open the **Others** branch at the end of the profile tree.
3. Right-click a profile with variable cross sections, and then select **Edit profile** to open the profile in the **Profile Editor**.
4. Modify the profile properties.
5. Click **Save**.

Define standardized values for parametric profiles

You can define standardized values for the dimensions of parametric profiles. The standardized values are visible in the profile catalog where you can select suitable dimension values for the profiles.

1. Under `..\ProgramData\Trimble\Tekla Structures\<version>\environments\<environment>` folder, locate the `industry_standard_profiles.inp` file.

The exact file location may vary depending on the folder structure of your environment files.

If there is no `industry_standard_profiles.inp` file in your environment, you can use the file of the default environment.

2. Copy the `industry_standard_profiles.inp` file and place it in your firm, project, or model folder.
3. Open the copied `industry_standard_profiles.inp` file using any standard text editor, for example, Microsoft Notepad.
4. Modify the file.

The file has the following format:

- profile and profile subtype
- parameters separated by spaces
- units for each parameter
- standardized values for each parameter.

Each dimension combination has its own row.

5. Save the file.

Example

For example, the standardized combinations of dimension values for a C profile are as follows:

C	h*b*t	
h	b	t
mm	mm	mm
75	35	5
75	35	6
75	35	7
100	40	7
100	40	8
100	40	9

Create an image of a profile

To illustrate the shape and dimensions of a profile you have created, you can create an image of it. Tekla Structures displays the image when you browse for profiles in the profile catalog. The image must be in Windows bitmap (.bmp) format and can be created with any bitmap editor, for example Microsoft Paint.

1. Take a screenshot of the profile you have drawn or sketched.

For example, press the **Print Screen (Prt Scr)** key to take a screenshot of your entire desktop. To take a screenshot of an active window, press **Alt +Print Screen**. The screenshot is placed on the clipboard.

2. Open the screenshot in any bitmap editor (for example, Microsoft Paint) and modify the image if necessary.
3. Save the image in .bmp format in the `..\ProgramData\Trimble\Tekla Structures\ folder.`

The file name must match the actual profile name. For example, if the profile name is `mysketch`, the image must be named `mysketch.bmp`.

4. Restart Tekla Structures.

The image is now shown in the profile catalog.

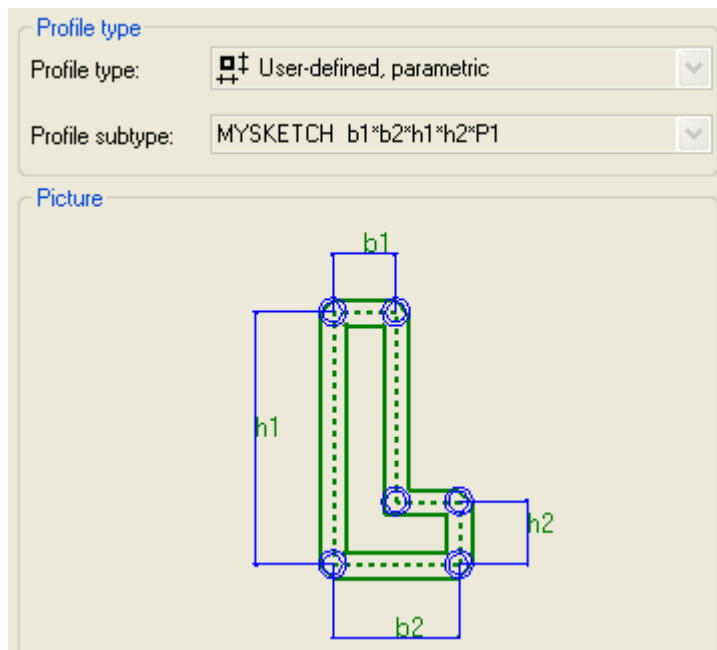

5.9 Customize the shape catalog

The shape catalog contains information on shapes that are used for defining items. Use the **Shape catalog** dialog box to view and modify shape properties and metadata, to group and tag shapes, and to import and export shapes.

The shape catalog includes default shapes, for example **Default** and **Concrete_Default**, and other shapes that are read from specific shape folders in a set [folder search order \(page 361\)](#). The shapes you [import \(page 212\)](#), download from [Tekla Warehouse](#), or [create using existing geometry \(page 217\)](#) in the currently open model are also shown in the shape catalog.

Shape definition files

For each shape in the shape catalog, there are two *definition files* that contain the shape information:

- One `.xml` file for shape attributes, such as name and GUID, stored in the `\Shapes` folder
- One `.tez` or `.xml` file for geometric properties, such as coordinates, stored in the `\ShapeGeometries` folder

Tekla Structures searches for these subfolders and definition files in the model, project, firm, and system folders, and in the folder defined by the advanced option `XS_DEFAULT_BREP_PATH`.

The definition files of the shapes that are used for items in a model are automatically copied to the model folder.

If you have shapes that you would like to have available in the shape catalog for all new models that are created in your project or company, copy the corresponding `.xml` and `.tez` files to the correct subfolders (`\Shapes` and `\ShapeGeometries`) in the `\profil` folder under your project or firm folder.

NOTE If your project, company, or environment uses a common location for shapes that are used in several Tekla Structures versions including 2017i and older, use `.xml` format for shape geometry files. The compressed `.tez` files do not work in Tekla Structures 2017i or older versions.

Group structure and other shape files

The hierarchical *group structure* of the shape catalog is read from the `ShapeCatalog.Groups.xml` file in the model folder. Using this file, the group structure can be shared with all users in a project preferably in the beginning of the project.

If you modify the group structure, Tekla Structures saves the changes to the `ShapeCatalog.Groups.user.<username>.xml` file in the model folder.

The `*.shapecatalog` and `*.ShapeCatalog.Groups.xml` files are used for exporting and importing shapes and the group structure between Tekla Structures models.

See also

[Import shapes \(page 212\)](#)

[Create shapes \(page 217\)](#)

[Work with shapes and groups in the shape catalog \(page 218\)](#)

[Export shapes \(page 224\)](#)

[Organize the shape catalog view \(page 226\)](#)

Import shapes

You can import the following types of shape files: `tsc`, `skp`, `dxf`, `dwg`, `ifc`, `ifcZIP`, `ifcXML`, `igs`, `iges`, `dgn`, `stp`, `step`, and `shapecatalog`.

When using other modeling software to model shapes that you want to import into Tekla Structures, we recommend that you center parts around the origin and direct the parts along the x axis.

From Tekla Structures models you can also import [shape catalog groups \(page 218\)](#) either with the shapes as `.shapecatalog` files or without the shapes as `.ShapeCatalog.Groups.xml` files.

1. Open the model to which you want to import shapes and/or shape catalog groups.
2. On the **File** menu, click **Catalogs** --> **Shape catalog** to open the **Shape catalog** dialog box.
3. To import shapes without the group structure to a certain group or sub-group in the shape catalog, select the group or sub-group on the left side of the dialog box.

If you do not select a group, Tekla Structures imports the shapes to the **Ungrouped** group.

4. Click  **Import**.
5. In the **Import shape definitions** dialog box, browse to the folder that contains the files to be imported, select the files, and then click **Open**.
Tekla Structures checks if there are duplicates in the shapes in the import files compared to the existing shape catalog.

In the **Import** dialog box, you can see the **Status** of each imported shape (e.g. New shape definition, Shape name already exists) and, if a shape has already been used in the model, the **Instances** of the shape.

6. If shapes with the same name and GUID as the shapes being imported already exist in the shape catalog, you can replace or keep the existing shapes. In the **Import** dialog box:

- Select the **Overwrite** check box for each existing shape that you want to replace with a new, imported shape.
 - Clear the **Overwrite** check box for each existing shape that you want to keep unchanged.
7. Click **Import** in the **Import** dialog box.
Importing a large file can take several minutes.
 8. Click **OK** to complete the import.

The groups that contain new or modified shapes are marked with  on the left side of the **Shape catalog** dialog box. The new or modified shape rows are highlighted in yellow in the list of shapes.

9. Click  **Save** to save changes to the shape catalog.

Shape import has three possible results:

- Tekla Structures imports the shape as a watertight solid shape. All solid operations are available.
- Tekla Structures imports the shape as a non-solid shape. A non-solid shape means that the object may not be watertight. For example, it has holes, or is missing a face or an edge.
- Import fails. This can happen, for example, if the shape is very complex or has no volume. There may also be a tolerance difference between Tekla Structures and the original software that was used to create the shape. To find out why the import failed, check the session history log by going to **File menu --> Logs --> Session history log**.

The **Solidity** column in the shape catalog shows if a shape is solid or non-solid.

When you import a shape into the shape catalog, Tekla Structures creates two files: one `.xml` file for shape attributes, such as the name and GUID, and one `.tez` file for geometric properties, such as coordinates. The files are saved in the current model folder under the `\Shapes` and `\ShapeGeometries` subfolders.

The shape name that is shown in the shape catalog is determined as follows:

- If you import a `.tsc` or `.shapecatalog` file, the shape name is read from the imported file.
- If you import other file types, the shape name is the name of the imported file.

TIP You can also download shapes from [Tekla Warehouse](#), or [create shapes using existing geometry \(page 217\)](#) in Tekla Structures models.

See also

[Example: Import a shape from SketchUp Pro \(page 214\)](#)

[Compress shape geometry files \(page 215\)](#)

[Clean shape geometry files \(page 216\)](#)

[Export shapes \(page 224\)](#)

[Customize the shape catalog \(page 210\)](#)

Example: Import a shape from SketchUp Pro

In this example, you import a solid 3D shape from Trimble SketchUp Pro to a Tekla Structures model.

1. Create an empty model in SketchUp Pro.
Delete any extra entities, such as the default person on the drawing area.

2. Create a group of entities.

Although Tekla Structures supports importing separate individual entities, we recommend you create a group of entities or a component in SketchUp.

All SketchUp groups and components should form watertight solids. Select the group or component and open **Entity Info** to check that the selection is a solid. SketchUp solids have a volume. If there is no volume listed, the selection is not a solid.

3. Select the group and click **Solid Tools** --> **Union** to make the group of entities into a union of solids.

Your group becomes a single solid volume: a solid.

4. Place the solid in SketchUp so that it lies along the positive x axis (red), and halfway on both y (green) and z axes (blue). In Tekla Structures, the yellow and magenta part handles will align with the x axis used in SketchUp.

The location and rotation of the solid in SketchUp are important, since they determine how an item is inserted and positioned in Tekla Structures. Different positioning in SketchUp causes an offset in Tekla Structures.

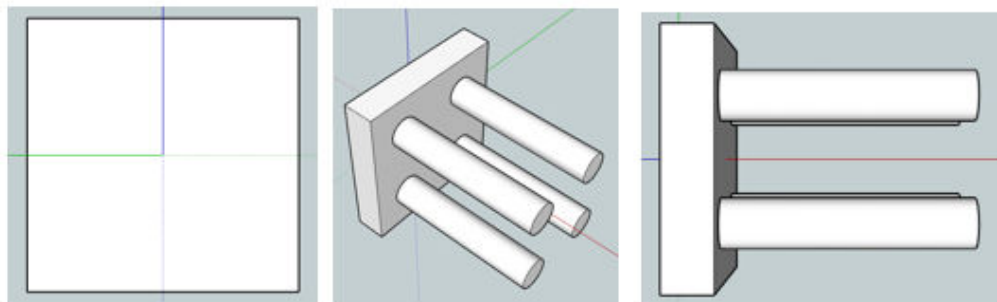

5. Save the SketchUp file.
6. In your Tekla Structures model, open the **Shape catalog** dialog box and

click  **Import**.

7. Select the SketchUp file.
8. Click **Import**.

Tekla Structures imports the shape to the shape catalog and you can use it to define the shape of an item or a concrete item.

See also

[Customize the shape catalog \(page 210\)](#)

[Import shapes \(page 212\)](#)

Compress shape geometry files

You can compress shape geometry files by converting the files from `.xml` format to compressed format `.tez`. Using the `.tez` format saves disk space.

In Tekla Model Sharing models, the shape geometry files are automatically converted from `.xml` to `.tez` when you use Tekla Structures 2018 or a newer version.

In older versions and in models that are not shared, you can manually compress the shape geometry files that are stored in the `\ShapeGeometries` subfolder in the current model folder. The files in the `\Shapes` subfolder will not be compressed.

If you have already used any of the shapes for items in the model, they will work the same way even after compression.

NOTE Compression is a permanent action, and you cannot undo it even if you do not save the model.

Do not compress shape geometry files if you need them in models that you will open using Tekla Structures 2017i or an older version. The `.tez` files do not work in those versions.

If your project, company, or environment uses a common location for shapes that are used in several Tekla Structures versions including 2017i and older, do not convert those shape geometry files to `.tez` format. Otherwise the shapes will not work in all versions.

How to compress shape geometry files

To compress existing shape geometry files, either [re-import the original shape files \(page 212\)](#), or use the **Compress shape geometries** application as follows:

1. Open the model whose shape geometry files you want to compress.

2. Click the **Applications & components** button  in the side pane to open the **Applications & components** catalog.
3. Search for the **Compress shape geometries** application, and then double-click to open it.
4. In the **Compress shape XML files to TEZ format** dialog box, click **Compress**.
5. Re-open the model.

Clean shape geometry files

If some previously imported shapes cause missing faces or edges in items or drawings, you can clean the shape geometry files. Cleaning means that Tekla Structures investigates and corrects the shape geometry and tries to create solid objects. This is useful with shapes that have been imported to Tekla Structures models prior to version 2018i.

The **Shape cleaner** application provides an option to create backups of the original shape geometry files and to revert to them, if needed.

How to clean shape geometry files

To clean existing shape geometry files, either [re-import the original shape files \(page 212\)](#), or use the **Shape cleaner** application as follows:

1. Open the model whose shape geometry files you want to clean.
2. Click the **Applications & components** button  in the side pane to open the **Applications & components** catalog.
3. Search for the **Shape cleaner** application, and then double-click to open it.

The **Shape cleaner** dialog box opens.

4. Select the shapes that you want to clean.
5. If you want to create backups of the shape geometry files, select the **Create backups from shapes before cleaning** check box.
6. Click **Clean**.

Tekla Structures cleans the shapes and shows how many shapes resulted in being solid objects and how many non-solid.

If you need to interrupt the cleaning process, you can click **Stop**.

7. Re-open the model to see the changed shape geometry in the items in the model.
8. If you are not happy with the result, and if you have created the backup files, you can go back to the original shape geometry files.
 - a. Open the **Shape cleaner** dialog box again.

- b. Select the shapes that you want to restore.
- c. Click **Revert**.

Create shapes

In addition to importing item shapes or downloading them from Tekla Warehouse, you can create shapes using existing geometry and parts in Tekla Structures models. For example, you can create a shape using a single part or several parts that have been attached to each other.

The part reference point that has the yellow handle determines the origin of the shape. The positive global x direction determines the direction of the shape. Later on when you create items using the shape, the shape origin and direction will align with the yellow and magenta item handles.

The shape name is generated using the part name and part location in the format <grid location>_<elevation>_<part name>. For example:

- 1/D_+0_FOOTING
- 3/C_+0-+3600_COLUMN
- 1-2/A-B_+3600_SLAB

If there is already a shape with the same name in the shape catalog, Tekla Structures adds two underscore characters and a running number at the end of the new shape name. For example, 1/D_+0_FOOTING__1.

Create a shape by using existing geometry in the model

Use this method if you want to create a new shape using an existing part, but you do not want to delete the part or change it to an item.

1. Using parts, model the geometry from which you want to create a shape.
2. If you want to include more than one part in the shape, attach the parts to each other.

3. On the **Edit** tab, click  **Create shape from geometry**.

4. Select the part.

Alternatively, you can first select the part, right-click, and then select **Create shape from geometry**.

Tekla Structures adds a new shape to the [shape catalog \(page 210\)](#).

You can then use the shape when you create items in the model. You can also modify items and shapes further in the **Geometry editing** mode.

Create a shape by converting a part to an item

When you change an existing part in the model to an item, Tekla Structures also creates a new shape and adds it to the shape catalog.

When you change a part to an item, Tekla Structures deletes the original part and replaces it with the newly created item in the model. The name, material, finish, class, pour phase, and the numbering properties of the original part are saved as the corresponding item properties. Other part type specific properties and user-defined attributes are not saved. The objects that are attached to the original part, such as reinforcement and surfaces, are deleted.

1. Create the parts that you want to change to an item.
2. If you want to include more than one part in the item, attach the parts to each other.



3. On the **Edit** tab, click  **Convert part to item**.

4. Select the part.

Alternatively, you can first select the part, right-click, and then select **Convert part to item**.

Tekla Structures changes the part to an item and adds a new shape to the [shape catalog \(page 210\)](#).

Work with shapes and groups in the shape catalog

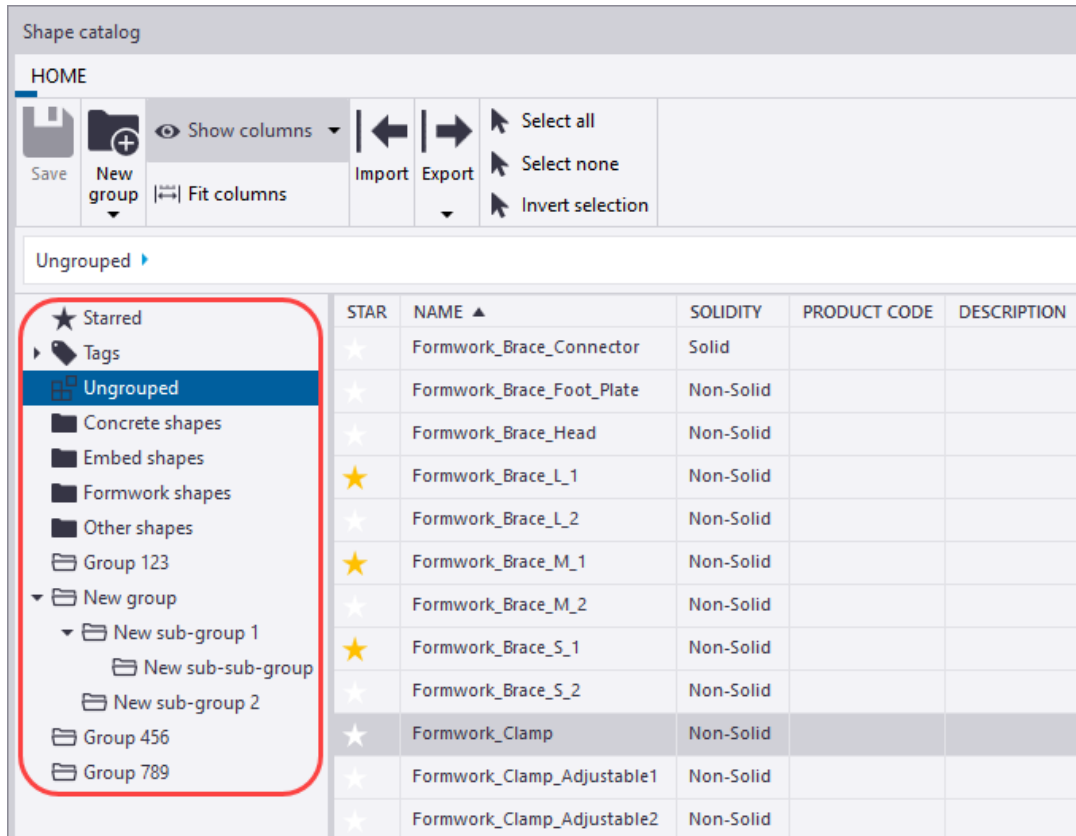

The shapes in the shape catalog can be arranged to a hierarchical group structure. The group structure is shown on the left side of the **Shape catalog** and **Select shape** dialog boxes. In the **Shape catalog** dialog box, you can add, modify, and delete groups and sub-groups, and move and copy shapes between the groups and sub-groups.



The group structure may vary depending on the Tekla Structures environment you are using, or your company or project administrator may have created and shared a group structure. The group structure is read from the `ShapeCatalog.Groups.xml` file in the model folder and from the `*.ShapeCatalog.Groups.xml` files in the shape subfolders in the project,

firm, and system (XS_SYSTEM) folders. Some shapes may first be in the  **Ungrouped** group, but if needed, you can regroup them.

The new shapes that you [create \(page 217\)](#) in the model are also added to the **Ungrouped** group. If you [import \(page 212\)](#) new shapes without the group structure, you can select a group for the shapes. You can also group shapes by [tagging or starring \(page 226\)](#) them.

The groups that are marked with  are system groups. The groups that are marked with  are user-defined groups.

The current user-defined groups and the changes you make to the group structure are stored in the `ShapeCatalog.Groups.user.<username>.xml` file in the model folder.

Note that even if you modify the group structure, the actual definition files (`.xml` and `.tez`) of each shape remain in the original `\Shapes` and `\ShapeGeometries` folders.

In the **Select shape** dialog box, which is used for selecting a shape for an item, also the  **Recent** group is shown. It contains the latest shapes that you have used.

Add a new group or sub-group

1. On the **File** menu, click **Catalogs** --> **Shape catalog** to open the **Shape catalog** dialog box.
2. If you want to add a sub-group to an existing group, select the group on the left side of the dialog box.

You can add sub-groups to both user-defined groups and system groups, but not to the **Starred**, the **Tags**, or the **Ungrouped** group.

3. Click  **New group** and do one of the following:
 - To create a highest-level group, select **New group**.
 - To add a sub-group under the selected group, select **New sub-group**.
4. In the **New group name** dialog box, type a name for the new group and click **Create**.
5. Add, move, or copy shapes to the new group, or modify the shape properties as needed.
See the instructions below.

6. Click  **Save** to save the changes to the shape catalog.

Modify a group or sub-group

For example, you can rename groups and sub-groups.

1. On the **File** menu, click **Catalogs** --> **Shape catalog** to open the **Shape catalog** dialog box.
2. Select the group or sub-group that you want to modify.
3. To rename the group, do the following:
 - a. Right-click and select **Rename**.
 - b. In the **Rename group** dialog box, type the new name and click **Rename**.
4. To modify group properties, such as the manufacturer or [tags \(page 228\)](#) of the shapes in the group, do the following:
 - a. Select all shapes in the group.

- b. In the property area on the right side of the **Shape catalog** dialog box, modify the properties.

5. Click  **Save** to save the changes to the shape catalog.

Move or copy a group or sub-group

You can move and copy groups and sub-groups in the shape catalog. You can move and copy both user-defined groups and system groups.

You cannot move or copy the **Starred**, the **Tags**, or the **Ungrouped** group, or sub-groups to them.

1. On the **File** menu, click **Catalogs** --> **Shape catalog** to open the **Shape catalog** dialog box.
2. Select the group or sub-group that you want to move or copy.
3. Do one of the following:
 - To move the group, drag the group to a new location in the group structure.
To move a sub-group to the highest level in the group structure, right-click and select **Move to top level**.
Also the sub-groups of the selected group are moved.
 - To copy the group, hold down **Ctrl** and drag the group to a new location.
To copy a sub-group to the highest level, right-click and select **Copy to top level**.
Also the sub-groups of the selected group are copied.

4. Click  **Save** to save the changes to the shape catalog.

Select shapes

You can use the following methods when you select shapes in the **Shape catalog** dialog box.

Selecting different sets of shapes is useful when you want to [export \(page 224\)](#) or [add tags \(page 228\)](#) to certain shapes, or otherwise modify a sub-set of shapes.



- Use the following commands on the catalog ribbon:
 - Click **Select all** to select all the shapes in the currently visible group.
Alternatively, you can select one shape and then press **Ctrl+A**.
 - Click **Select none** to clear the current selection.

- Click **Invert selection** to select the currently unselected shapes and to deselect the currently selected shapes.
- To select several consecutive shapes, select the first shape, then hold down **Shift** and select the last shape.
- To select several non-consecutive shapes, select the first shape, then hold down **Ctrl** and select the other shapes.

Preview a shape

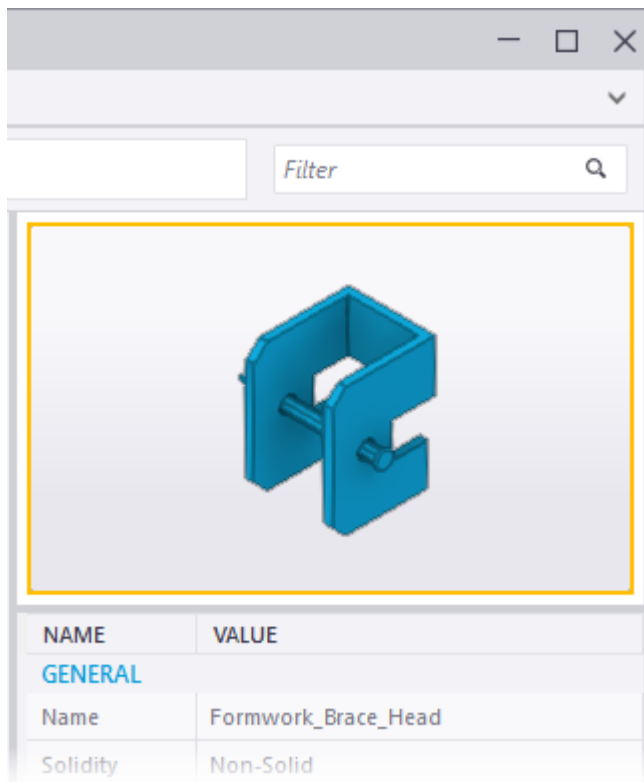
In the **Shape catalog** and **Select shape** dialog boxes, Tekla Structures shows a preview of the selected shape in the upper right corner of the dialog box. Use the following methods to examine the shape in the preview.



- Zoom in and out by scrolling with the mouse wheel
- Rotate the shape using the left mouse button ()
- Pan using the middle mouse button ()
- Adjust the viewing angle using the right mouse button ()

Move or copy shapes between groups

1. On the **File** menu, click **Catalogs** --> **Shape catalog** to open the **Shape catalog** dialog box.
2. Browse to and select the group from which you want to move or copy shapes.
3. Do one of the following:
 - To move one or more shapes to another group, select the shapes and drag them to the other group.
The shapes are removed from the selected group.
 - To copy one or more shapes to another group, select the shapes, hold down **Ctrl**, and then drag the shapes to the other group.
The shapes also remain in the selected group.
 - To remove one or more shapes from the selected group, select the shapes, right-click on one of the selected shapes, and then select **Remove from group**.
If the shapes only belong to the selected group, the shapes are moved to the **Ungrouped** group. If the shapes also belong to any other group, they remain in that group.
4. Click  **Save** to save the changes to the shape catalog.

Modify shape properties

1. On the **File** menu, click **Catalogs** --> **Shape catalog** to open the **Shape catalog** dialog box.
2. Browse to and select the group in which you want to modify shape properties.
3. Select one or more shapes.
4. In the property area on the right side of the **Shape catalog** dialog box, modify the shape properties.
For example, you can add a description or [tags \(page 228\)](#) to the selected shapes.
Note that you cannot rename shapes, or remove or change the solidity information, Tekla Structures version, source file location, or GUIDs of the shapes.
5. Click  **Save** to save the changes to the shape catalog.

Delete a group or sub-group, or shapes

You can delete groups, sub-groups, and shapes within the groups from the shape catalog. You can delete both the groups and the actual shapes at the same time, or you can delete groups and shapes separately.

Before you delete shapes, ensure that any shape you want to delete is not used for items in your Tekla Structures model. When you delete a shape from the shape catalog, the shape is no longer available anywhere in the model.

If you try to delete shapes that are used for items in the model or whose definition files are not in the model folder, Tekla Structures will not delete those shapes.

1. On the **File** menu, click **Catalogs** --> **Shape catalog** to open the **Shape catalog** dialog box.

2. Select a group or sub-group on the left side of the dialog box.

3. Do one of the following:

- To only delete the group but not the shapes in it, right-click on the group and select **Delete**.

If the shapes only belong to the deleted group, the shapes are moved to the **Ungrouped** group. If the shapes also belong to any other group, they remain in that group.

- To delete both the group and the shapes in it, right-click on the group and select **Delete with shapes**.

- To only delete certain shapes in the group, select one or more unused model-folder shapes, right-click on one of the shapes, and then select **Delete**.

4. Click **Yes** to confirm the deletion.





5. Click **Save** to save the changes to the shape catalog.

Export shapes

You can export shapes and shape catalog groups together or separately from each other.

1. Open the model from which you want to export shapes and/or shape catalog groups.
2. On the **File** menu, click **Catalogs** --> **Shape catalog** to open the **Shape catalog** dialog box.
3. Choose from the following options to export shapes and/or groups:

To	Do this
Export all the shapes in the catalog, but not the group structure	On the Shape catalog ribbon, click  Export --> Export all shapes.
Export all the shapes and groups in the catalog	On the Shape catalog ribbon, click  Export --> Export all shapes with groups.
Export the group structure of the catalog, but not the actual shapes	On the Shape catalog ribbon, click  Export --> Export group structure only.
Export all the shapes in a group or sub-group	Select the group or sub-group, right-click, and select Export shapes. For example, you can export the shapes in the Starred group, or groups of tagged shapes.
Export all the shapes in a group or sub-group and also the group	Select the group or sub-group, right-click, and select Export shapes with group.
Export a group or sub-group and its sub-groups, but not the actual shapes	Select the group or sub-group, right-click, and select Export group structure only.
Export one or more individual shapes	Select the shapes (page 221) , right-click, and select Export.

4. In the **Export to** dialog box, browse to a folder, type a name for the export file, and then click **Save**.

If you are only exporting one individual shape, browse to and select a folder for the export file, and click **Select folder** in the **Export to** dialog box. The shape name is used as the name of the export file.

Tekla Structures saves the export file to the selected folder. When the export is completed, you can click **Open folder** to open the export folder.

The file name extension of the export file depends on the exported content, being:

- `.tsc` if only one shape is exported
- `.shapecatalog` if several shapes or both shapes and groups are exported
- `.ShapeCatalog.Groups.xml` if only the group structure is exported

TIP You can also upload shapes to [Tekla Warehouse](#).

See also

[Import shapes \(page 212\)](#)

[Customize the shape catalog \(page 210\)](#)

Organize the shape catalog view

You can organize the shape catalog view in the **Shape catalog** dialog box to suit your needs and ways of working. For example, you can hide certain property columns, or change the order of the property columns. You can also filter shapes and mark them with stars and tags.

Some of these methods work the same way also in the **Select shape** dialog box: showing and hiding property columns, changing the order of the columns, filtering, and starring. The **Select shape** dialog box opens when you click the ... button next to the **Shape** box in the item properties, or in a component dialog box, to select a shape.

The changes you make to the dialog box layout are automatically saved to the `shape_catalog.settings.UI` file in the `..\Users\<user>\AppData\Local\Trimble\Tekla Structures\<version>\Catalogs\` folder. Tekla Structures will use the saved layout next time you open the dialog box.

Show or hide the catalog ribbon

If needed, you can show or hide the ribbon in the **Shape catalog** dialog box and in the **Select shape** dialog box.





By default, the ribbon is shown in the **Shape catalog** dialog box, but hidden in the **Select shape** dialog box.

- To show the ribbon, click the down arrow ▼ at the right end of the **(Home)** ribbon title bar.
- To hide the ribbon, click the up arrow ▲ at the right end of the **(Home)** ribbon title bar.

Work with property columns in the catalog view

You can organize the shape catalog view in the **Shape catalog** dialog box and in the **Select shape** dialog box by showing and hiding the property columns, and by changing the order, sort order, and width of the columns.

The **Star** column is always visible and you cannot hide it.

To	Do this
Show or hide a property column	<ol style="list-style-type: none"> 1. Click  Show columns to open a list of the available property columns. A check mark in front of a column name indicates that the column is visible. 2. To show a column, click the column name to add a check mark in front of the column name. 3. To hide a column, click the column name to remove the check mark.
Change the order of the property columns	Drag a column header to a new location.
Change the sort order of a property column	<p>Click the column header.</p> <p>The arrow symbol next to the column header indicates if the sort order is ascending  or descending .</p> <p>To sort values by two properties and in two columns:</p> <ol style="list-style-type: none"> 1. Sort by one column. 2. Hold down Shift and then sort by the other column.
Resize a property column	<p>Drag the edge between this and the following column header. For example:</p> <div data-bbox="850 1413 1062 1458" style="border: 1px solid gray; padding: 2px; display: inline-block;"> GRADE  SIZE </div> <p>You can also click  Fit columns to adjust the widths of the visible columns so that the longest value in each column (or the column header in the shape catalog) is shown. This does not affect the widths of the columns you have manually resized.</p>

Filter shapes

You can filter shapes in both the **Shape catalog** dialog box and the **Select shape** dialog box. You can use filtering together with the other methods, such

as sorting, to narrow down the number of shapes shown in the shape catalog view.

1. On the **File** menu, click **Catalogs --> Shape catalog** to open the **Shape catalog** dialog box.

Alternatively, you can use the **Select shape** dialog box.

2. In the **Filter** box, type the search term or filtering criteria.
3. Select a group or sub-group.

Tekla Structures shows the matching shapes in the selected group.

Add stars to shapes

You can mark important or preferred shapes with stars, so that you can easily find these shapes later. The shapes that are marked with stars appear in the **Starred** group in the shape catalog. Starring is user-specific, so it is only visible to you.

The starring settings are stored in the `shape_catalog.settings.user.<username>` file in the current model folder.

1. On the **File** menu, click **Catalogs --> Shape catalog** to open the **Shape catalog** dialog box.

Alternatively, you can use the **Select shape** dialog box.

2. Browse or search for the shapes that you want to mark with stars.
3. In the list of shapes, click the white star symbol  in the **Star** column for each shape that you want to add to the **Starred** group.

By default, the **Star** column is the first column and the star symbol is at the beginning of each shape row.

The star symbol turns yellow  and the shape is added to the **Starred** group.

4. To remove the starring from a shape, click the yellow star symbol on the shape row.

The star symbol turns white again and the shape is removed from the **Starred** group.

Add tags to shapes

In the **Shape catalog** dialog box, you can add tags to shapes. Use tags to add keywords or other metadata to the shapes.

Tags are model-specific and saved to the `ShapeCatalog.Groups.User.<username>.xml` file in the current model folder.

1. On the **File** menu, click **Catalogs --> Shape catalog** to open the **Shape catalog** dialog box.
2. [Select the shapes \(page 221\)](#) that you want to tag.
3. Type the tag in the **Tags** box at the bottom-right corner of the **Shape catalog** dialog box, and then press **Enter**.

To add several tags to a shape, type the next tag in the next tag box and press **Enter**.

Each group of tagged shapes appears with the  symbol under **Tags** in the list of groups.

4. To remove a tag from a shape, select the shape and click the **X** symbol after the tag name in the **Tags** section in the property area.
5. To delete a tag completely, select the tagged group, select all the shapes in the group, and then click the **X** symbol after the tag name in the **Tags** section in the property area.

6. Click  **Save** to save the changes to the shape catalog.

5.10 Customize the bolt catalog

The individual *bolt assembly elements*, such as bolts of different sizes and lengths, nuts and washers, are listed in the bolt catalog. Each *bolt assembly* then consists of these bolt assembly elements. You cannot use a bolt if it does not belong to a bolt assembly. The bolt assemblies are listed in the bolt assembly catalog.

Tekla Structures stores the bolt catalog information in the `screwdb.db` file and the bolt assembly catalog information in the `assdb.db` file.

See also

[How the bolt catalog and bolt assembly catalogs work together \(page 230\)](#)

[Manage bolts and bolt assemblies \(page 230\)](#)

[Import and export bolts and bolt assemblies \(page 235\)](#)

[Bolt length calculation \(page 240\)](#)

How the bolt catalog and bolt assembly catalogs work together

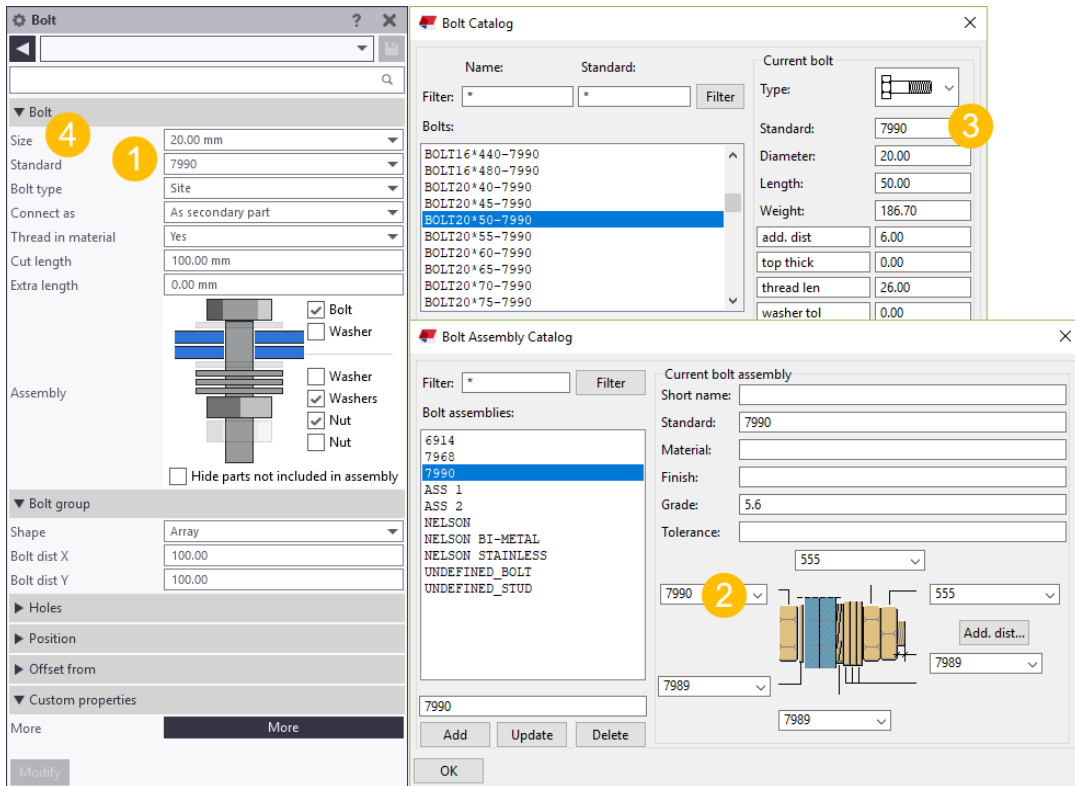

- (1) The **Bolt standard** options are read from the bolt assembly catalog.
- (2) The bolt assembly catalog defines which bolt standard is used in the bolt assembly.
- (3) The bolt catalog contains the different bolt diameters, lengths, and other properties used in the bolt standard.
- (4) The **Bolt size** options are read from the bolt catalog depending on the selected **Bolt standard** option.

See also

[Customize the bolt catalog \(page 229\)](#)

[Bolt catalog properties \(page 243\)](#)

[Bolt assembly catalog properties \(page 245\)](#)

Manage bolts and bolt assemblies

This section describes how to manage bolts and bolt assemblies using the bolt catalog and the bolt assembly catalog. You can add, modify, and delete bolts and bolt assemblies.

Click the links below to find out more:

[Add a bolt to the catalog \(page 231\)](#)

[Add a stud bolt to the catalog \(page 232\)](#)

[Modify bolt information in the catalog \(page 233\)](#)

[Delete a bolt from the catalog \(page 234\)](#)

[Add a bolt assembly to the catalog \(page 234\)](#)

[Modify bolt assembly information in the catalog \(page 235\)](#)

[Delete a bolt assembly from the catalog \(page 235\)](#)

Add a bolt to the catalog

You need to add individual bolt elements, such as bolts, nuts, and washers, to the bolt catalog before you can define bolt assemblies and use them in a model.

The following steps are for adding bolts, but they also apply to adding nuts and washers.

1. On the **File** menu, click **Catalogs** --> **Bolt catalog** to open the **Bolt Catalog** dialog box.
2. Enter the name of the bolt in the following box:

A screenshot of a software dialog box. At the top is a rectangular text input field. Below it are three buttons arranged horizontally: 'Add', 'Update', and 'Delete'. Each button has a light gray background and a thin border.

You can enter a maximum of 40 characters in the name box.

3. In the **Type** list, select an option to define the bolt element type.
4. Define the other properties of the new bolt.

You can enter a maximum of 25 characters in the **Standard** box.

Use different names for bolt, nut, washer, and stud standards to distinguish bolt element types from each other when defining bolt assemblies.

5. Click **Add** to add the bolt to the bolt catalog.

You cannot use a bolt if it does not belong to a bolt assembly. Therefore, we recommend checking that the catalog also includes nuts and washers that work with the new bolt so that you can create a bolt assembly. If the

catalog does not include suitable nuts and washers, add them the same way as you added the new bolt.

6. Click **OK**.

The **Save confirmation** dialog box appears.

7. Select **Save changes to model folder** to save the changes in the `screwdb.db` file in the current model folder, and then click **OK**.

TIP You can also add bolts by importing them to the bolt catalog.

See also

[Import bolts to the catalog \(page 236\)](#)

[Add a stud bolt to the catalog \(page 232\)](#)

[Modify bolt information in the catalog \(page 233\)](#)

[Delete a bolt from the catalog \(page 234\)](#)

[Bolt length calculation \(page 240\)](#)

[Bolt catalog properties \(page 243\)](#)

[Add a bolt assembly to the catalog \(page 234\)](#)

Add a stud bolt to the catalog

A stud is special type of bolt that is welded to steel parts to transfer loads between steel and concrete. You cannot use studs unless you have defined a stud assembly that contains the assembly's name and material.

1. On the **File** menu, click **Catalogs** --> **Bolt catalog** to open the **Bolt Catalog** dialog box.
2. Enter values for the following properties:
 - **Name:** Name for the stud bolt.

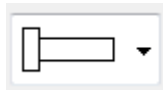

- **Type:**
- **Standard:** This name is needed when creating a bolt assembly for the stud.
- **Diameter:** Shank diameter.
- **Length:** Stud length.
- **Weight:** Stud weight.
- **top thick:** Head thickness.

- **top diameter:** Head diameter.

The units depend on the settings in **File menu --> Settings --> Options --> Units and decimals** .

3. On the **File** menu, click **Catalogs --> Bolt assembly catalog** to open the **Bolt Assembly Catalog** dialog box.
4. Select the standard for the stud bolt.
5. Set all the other bolt assembly elements to **None**.

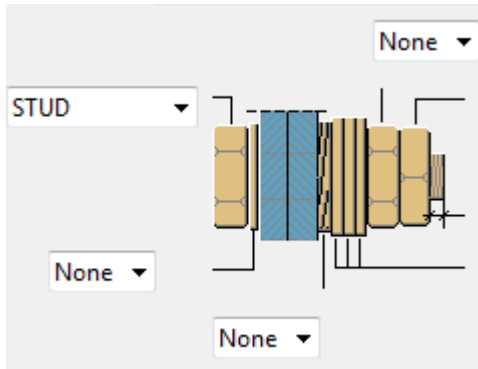

6. To create studs in the model, create bolts and select the stud assembly standard.

See also

[Bolt catalog properties \(page 243\)](#)

Modify bolt information in the catalog

1. On the **File** menu, click **Catalogs --> Bolt catalog** to open the **Bolt Catalog** dialog box.
2. Select a bolt from the list.
3. Modify the properties.
4. Click **Update**.
5. Click **OK**.

The **Save confirmation** dialog box appears.

6. Select **Save changes to model folder** to save the changes in the `screwdb.db` file in the current model folder, and then click **OK**.

See also

[Add a bolt to the catalog \(page 231\)](#)

[Delete a bolt from the catalog \(page 234\)](#)

[Bolt catalog properties \(page 243\)](#)

Delete a bolt from the catalog

1. On the **File** menu, click **Catalogs** --> **Bolt catalog** to open the **Bolt Catalog** dialog box.
2. Select a bolt from the list.
Use the **Shift** and **Ctrl** keys to select multiple bolts.
3. Click **Delete**.
4. Click **OK**.
The **Save confirmation** dialog box appears.
5. Select **Save changes to model folder** to save the changes in the `screwdb.db` file in the current model folder, and then click **OK**.

See also

[Add a bolt to the catalog \(page 231\)](#)

[Modify bolt information in the catalog \(page 233\)](#)

Add a bolt assembly to the catalog

You can add new bolt assemblies to the bolt assembly catalog. Note that the bolt assembly can contain only bolts or studs, not both of them.

1. On the **File** menu, click **Catalogs** --> **Bolt assembly catalog** to open the **Bolt Assembly Catalog** dialog box.
2. Enter the name of the bolt assembly in the following box:



The image shows a dialog box with a text input field at the top. Below the input field are three buttons: "Add", "Update", and "Delete".

3. Define the other properties of the new bolt assembly.
You can enter a maximum of 30 characters in the **Standard** box. For all the other properties, you can enter a maximum of 25 characters.
4. Click **Add** to add the bolt assembly to the catalog.
5. Click **OK**.
The **Save confirmation** dialog box appears.
6. Select **Save changes to model folder** to save the changes in the `assdb.db` file in the current model folder, and then click **OK**.

See also

[Import bolt assemblies to the catalog \(page 237\)](#)

[Modify bolt assembly information in the catalog \(page 235\)](#)

[Delete a bolt assembly from the catalog \(page 235\)](#)

[Bolt assembly catalog properties \(page 245\)](#)

Modify bolt assembly information in the catalog

1. On the **File** menu, click **Catalogs** --> **Bolt assembly catalog** to open the **Bolt Assembly Catalog** dialog box.
2. Select a bolt assembly from the list.
3. Modify the [properties \(page 245\)](#).
4. Click **Update**.
5. Click **OK**.
The **Save confirmation** dialog box appears.
6. Select **Save changes to model folder** to save the changes in the `assdb.db` file in the current model folder, and then click **OK**.

See also

[Add a bolt assembly to the catalog \(page 234\)](#)

[Delete a bolt assembly from the catalog \(page 235\)](#)

[Bolt assembly catalog properties \(page 245\)](#)

Delete a bolt assembly from the catalog

1. On the **File** menu, click **Catalogs** --> **Bolt assembly catalog** to open the **Bolt Assembly Catalog** dialog box.
2. Select a bolt assembly from the list.
3. Click **Delete**.
4. Click **OK**.
The **Save confirmation** dialog box appears.
5. Select **Save changes to model folder** to save the changes in the `assdb.db` file in the current model folder, and then click **OK**.

See also

[Add a bolt assembly to the catalog \(page 234\)](#)

[Modify bolt assembly information in the catalog \(page 235\)](#)

Import and export bolts and bolt assemblies

Use importing and exporting for merging bolts and bolt assemblies across catalogs. Bolts are imported and exported as `.bolts` files, bolt assemblies as `.bass` files, and bolt catalogs as `.lis` files.

When you export single bolts or bolt assemblies, you can select the bolts or bolt assemblies you want to include in the `.bolts` or `.bass` file. When you import and export bolt assemblies, also all the related bolt elements (bolts, studs, screws, nuts, washers) are included in the `.bass` file.

You can import and export an entire bolt catalog. You can also import a part of an exported bolt catalog.

Importing and exporting bolt catalogs is useful, when you:

- Upgrade to newer version of Tekla Structures and you want to use a customized bolt catalog from a previous version.
- Want to combine bolt catalogs that are stored in different locations.
- Want to share bolt catalog information with other users.

TIP You can also download or share bolt assemblies using Tekla Warehouse.

See also

[Import bolts to the catalog \(page 236\)](#)

[Export bolts from the catalog \(page 237\)](#)

[Import bolt assemblies to the catalog \(page 237\)](#)

[Export bolt assemblies from the catalog \(page 238\)](#)

[Import a bolt catalog \(page 238\)](#)

[Import a part of the bolt catalog \(page 239\)](#)

[Export an entire bolt catalog \(page 240\)](#)

Import bolts to the catalog

Bolts are imported and exported as `.bolts` files. A `.bolts` file can include one bolt or several bolts.

1. On the **File** menu, click **Catalogs** --> **Bolt catalog** to open the **Bolt Catalog** dialog box.
2. Right-click in the **Bolts** list and select **Import**.
3. Select the import file.
4. Click **OK**.

The bolts are displayed on the **Bolts** list by their original names.

5. Click **OK**.
The **Save confirmation** dialog box appears.
6. Select **Save changes to model folder** to save the changes in the `screwdb.db` file in the current model folder, and then click **OK**.

See also

[Add a bolt to the catalog \(page 231\)](#)

[Import a bolt catalog \(page 238\)](#)

[Import a part of the bolt catalog \(page 239\)](#)

[Import bolt assemblies to the catalog \(page 237\)](#)

[Export bolts from the catalog \(page 237\)](#)

Export bolts from the catalog

Bolts are imported and exported as `.bolts` files. A `.bolts` file can include one bolt or several bolts.

1. On the **File** menu, click **Catalogs** --> **Bolt catalog** to open the **Bolt Catalog** dialog box.
2. Select bolts from the **Bolts** list.
Use the **Shift** and **Ctrl** keys to select multiple bolts.
3. Right-click in the **Bolts** list and select **Export**.
4. Browse for the folder where you want to save the export file.
5. Enter a name for the file in the **Selection** box.
6. Click **OK**.

See also

[Export bolt assemblies from the catalog \(page 238\)](#)

[Export an entire bolt catalog \(page 240\)](#)

[Import bolts to the catalog \(page 236\)](#)

Import bolt assemblies to the catalog

Bolt assemblies are imported and exported as `.bass` files. A `.bass` file can include one bolt assembly or several bolt assemblies.

1. On the **File** menu, click **Catalogs** --> **Bolt assembly catalog** to open the **Bolt Assembly Catalog** dialog box.
2. Right-click in the **Bolt assemblies** list and select **Import**.

3. Select the import file.
4. Click **OK**.

The bolt assemblies are displayed on the **Bolt assemblies** list by their original names.

5. Click **OK**.

The **Save confirmation** dialog box appears.

6. Select **Save changes to model folder** to save the changes in the `assdb.db` file in the current model folder, and then click **OK**.

See also

[Add a bolt assembly to the catalog \(page 234\)](#)

[Import a bolt catalog \(page 238\)](#)

[Import bolts to the catalog \(page 236\)](#)

[Export bolt assemblies from the catalog \(page 238\)](#)

Export bolt assemblies from the catalog

Bolt assemblies are imported and exported as `.bass` files. A `.bass` file can include one bolt assembly or several bolt assemblies.

1. On the **File** menu, click **Catalogs** --> **Bolt assembly catalog** to open the **Bolt Assembly Catalog** dialog box.
2. Select bolt assemblies from the **Bolt assemblies** list.
Use the **Shift** and **Ctrl** keys to select multiple bolt assemblies.
3. Right-click in the **Bolt assemblies** list and select **Export**.
4. Browse for the folder where you want to save the export file.
5. Enter a name for the file in the **Selection** box.
6. Click **OK**.

See also

[Export an entire bolt catalog \(page 240\)](#)

[Export bolts from the catalog \(page 237\)](#)

[Import bolt assemblies to the catalog \(page 237\)](#)

Import a bolt catalog

Bolt catalogs are imported to Tekla Structures models as `.lis` files.

1. Open the model to which you want to import a bolt catalog.

2. Copy the `screwdb.lis` file that you want to import to the current model folder.
3. To import the bolt catalog file `screwdb.lis` from the current model folder, go to **Quick Launch**, start typing `import bolt catalog`, and select the **Import Bolt Catalog** command from the list that appears.
Tekla Structures does not replace the entries that have the same names as the entries in the import file.
4. Check the status bar for error messages.
To view errors, go to the **File** menu and click **Logs --> Session history log**.

See also

[Import a part of the bolt catalog \(page 239\)](#)

[Export an entire bolt catalog \(page 240\)](#)

Import a part of the bolt catalog

If you do not want to import the entire bolt catalog, you can select the parts to be imported.

TIP If you only want to import a few bolts or bolt assemblies, use the import and export commands of the corresponding catalogs.

1. Open the model that contains the bolt catalog you want to use.
2. Go to **Quick Launch**, start typing `export bolt catalog`, and select the **Export Bolt Catalog** command from the list that appears.
The bolt catalog is saved as the `screwdb.lis` file in the current model folder.
3. Open the `screwdb.lis` file using a text editor, for example, Microsoft Notepad.
Each entry is listed on a separate row.
4. Delete the unwanted rows from the file.

WARNING Do not delete the `STARTLIST` and `ENDLIST` rows.

5. Save the file with the name `screwdb.lis`.
6. Open the model to which you want to import the bolt catalog.
7. Copy the `screwdb.lis` file that you want to import to the current model folder.

8. To import the bolt catalog file `screwdb.lis` from the current model folder, go to **Quick Launch**, start typing `import bolt catalog`, and select the **Import Bolt Catalog** command from the list that appears.

See also

[Import bolts to the catalog \(page 236\)](#)

[Import bolt assemblies to the catalog \(page 237\)](#)

[Import a bolt catalog \(page 238\)](#)

[Export an entire bolt catalog \(page 240\)](#)

Export an entire bolt catalog

Bolt catalogs are exported from Tekla Structures models as `.lis` files.

1. Open the model that contains the bolt catalog you want to export.
2. Go to **Quick Launch**, start typing `export bolt catalog`, and select the **Export Bolt Catalog** command from the list that appears.

The exported bolt catalog is the `screwdb.lis` file in the current model folder.

TIP The **Export Bolt Catalog** command exports the entire bolt catalog. To export only part of the bolt catalog, modify the export file to contain only the required elements. You can also export bolts from the **Bolt Catalog** dialog box or bolt assemblies from the **Bolt Assembly Catalog** dialog box.

See also

[Export bolt assemblies from the catalog \(page 238\)](#)

[Export bolts from the catalog \(page 237\)](#)

[Import a bolt catalog \(page 238\)](#)

[Import a part of the bolt catalog \(page 239\)](#)

Bolt length calculation

Tekla Structures uses values from the bolt catalog and the bolt assembly catalog when calculating the bolt length. If the bolt catalog does not contain long enough bolts for your purposes, you need to add them to the bolt catalog.

The following **Assembly** settings in the **Bolt** properties affect the bolt length calculation process. If the check box is selected, the bolt element is used in the bolt assembly.

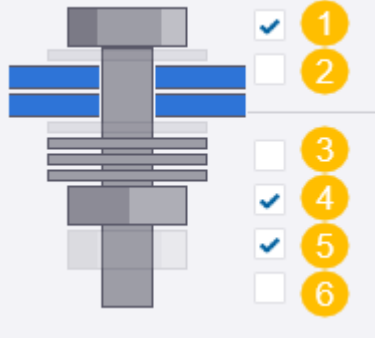
Bolt assembly	Bolt elements
	<p>1: If the check box is clear, only a hole is created</p> <p>2: Washer (1)</p> <p>3: Washer (2)</p> <p>4: Washers (3)</p> <p>5: Nut (1)</p> <p>6: Nut (2)</p>

The chart and the detailed steps below explain the process of bolt length calculation.

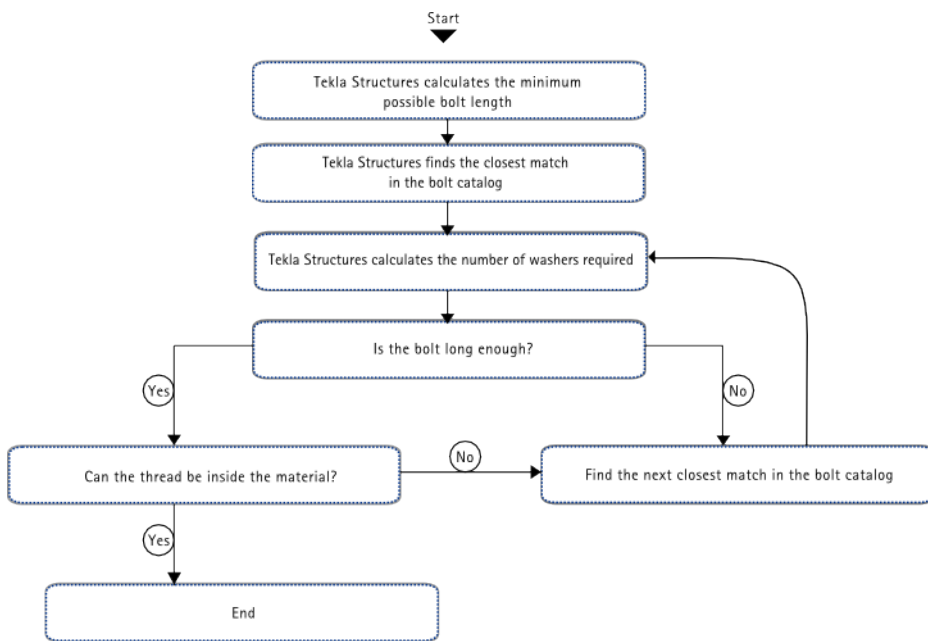

1. Tekla Structures calculates the **minimum possible length** of the bolt as follows:

washer (1) thickness (if the check box is selected) +
 material thickness +
 washer (2) thickness (if the check box is selected) +
 washer (3) thickness (if the check box is selected) +
 nut (1) thickness +

- nut (2) thickness +
extra length
2. Tekla Structures searches for the **closest match** in the bolt catalog.
 3. Tekla Structures calculates the **number of washers required** (must not exceed 10) so that the **length of the shaft is less than:**
 nut (1) thickness +
 material thickness +
 nut (2) thickness +
 washer (1) thickness +
 washer (2) thickness +
 (number of washers*washer (3) thickness)
 4. Tekla Structures checks that the **bolt found in step 2 is longer than:**
 extra length +
 nut (1) thickness +
 material thickness +
 nut (2) thickness +
 add. dist (from the bolt catalog) +
 washer (1) thickness +
 washer (2) thickness +
 (number of fitting washers * washer (3) thickness)
 5. If the selected bolt does not fulfill the criteria in step 4, Tekla Structures returns to step 2, otherwise it continues on to step 6.
 6. Tekla Structures checks that the selected bolt fulfills **all the following conditions:**
 - Can the thread be inside the material to be connected? Even if this is **not** allowed, the calculation always allows 3 or 4 mm of thread to be inside the material, depending on the bolt diameter. If the bolt diameter is ≥ 24 mm, it allows 4 mm, otherwise it allows 3 mm.
 - Shaft length must be more than:
 material thickness +
 extra length +
 washer (1) thickness (if checked) -
 maximum thread in material allowed (if thread in material = no) =
 3 mm or 4 mm
 - Shaft length is calculated as:
 Screw length - screw thread length - thread end.

- Thread end is the part of the bolt between the shaft and the thread. It is calculated as follows:

Diameter of bolt (mm)	Thread end (mm)
>33.0	10.0
>27.0	8.0
>22.0	7.0
>16.0	6.0
>12.0	5.0
>7.0	4.0
>4.0	2.5
≤4	1.5

7. If the selected bolt does not fulfill **all** the above conditions, Tekla Structures returns to step 2 and tries the next longest bolt.
8. If the advanced option `XS_BOLT_LENGTH_EPSILON` is set, the epsilon thickness is added to, or subtracted from, the material thickness to avoid inaccurate bolt length calculation.

For example, if this value is not taken into account, and the calculated length is 38.001 mm, a 39 mm bolt might be selected.

See also



[How the bolt catalog and bolt assembly catalogs work together \(page 230\)](#)

[Add a bolt to the catalog \(page 231\)](#)

Bolt catalog properties

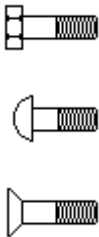
Use the **Bolt Catalog** dialog box to view and modify the properties of individual bolt elements, such as bolts, washers, and nuts. The units depend on the settings in **File menu** --> **Settings** --> **Options** --> **Units and decimals** .

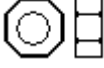
Option	Description
Type	<p>The type of the bolt element. The options are:</p> 

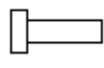
Option	Description
	 (Nut)  (Washer)  (Stud)
Standard	<p>The name of the bolt element standard.</p> <p>Used in the Bolt Assembly Catalog dialog box for defining bolt elements in a bolt assembly.</p> <p>Use different names for bolt, nut, washer, and stud standards to distinguish bolt element types from each other.</p>
Diameter	The diameter of the bolt element.
Length	The length of the bolt element.
Weight	The weight of the bolt element.
add. dist	<p>The length of the part of the bolt that protrudes from the nut.</p> <p>The value is used in bolt length calculation.</p>
top thick	The thickness of the bolt head.
thread len	<p>The length of the threaded part of the bolt shaft.</p> <p>The value is not used in bolt length calculation (value is 0) if the bolt is fully-threaded.</p>
washer tol	<p>The tolerance between the washer inner diameter and the bolt diameter.</p> <p>The value is used when searching for the correct-sized washer for the bolt. Not used in bolt length calculation.</p>
span size	The size of the wrench needed.
calc thick	<p>The calculation thickness of a nut or a washer.</p> <p>This value is used in bolt length calculation.</p>
real thick	<p>The true thickness of a nut or a washer.</p> <p>This is for information only.</p>
inner diam	<p>The inner diameter of a nut or a washer.</p> <p>This is for information only.</p>
outer diam	<p>The outer diameter of a nut or a washer.</p> <p>This is for information only.</p>

Option	Description
top diam	<p>The diameter of the hexagon.</p>  <p>This is for information only.</p>

See also

[Add a bolt to the catalog \(page 231\)](#)

[How the bolt catalog and bolt assembly catalogs work together \(page 230\)](#)

Bolt assembly catalog properties

Use the **Bolt Assembly Catalog** dialog box to view and modify the properties of bolt assemblies. The units depend on the settings in **File menu --> Settings --> Options --> Units and decimals** .

Option	Description
Short name	This name is used in drawings and reports. It is usually the commercial name for a specific bolt.
Standard	<p>This name is the full name which is shown in the bolt assemblies list in the Bolt Assembly Catalog dialog box, and in the Bolt standard list in the Bolt Properties dialog box.</p> <p>The value is used in bolt length calculation.</p>
Material	The material of the bolt assembly.
Finish	The type of the finish.
Grade	The grade of the bolt assembly.
Tolerance	<p>The tolerances of the bolt assembly.</p> <p>This is for information only. The values cannot be reported, for example.</p>

Additional length for bolt calculation

Option	Description
Add. dist...	<p>The Additional Distance option controls how much of the bolt protrudes from the nut.</p> <p>Additional Distance updates the Additional Distance values of all bolts that use the selected bolt standard and have the selected diameter.</p> <p>The value is used in bolt length calculation.</p>

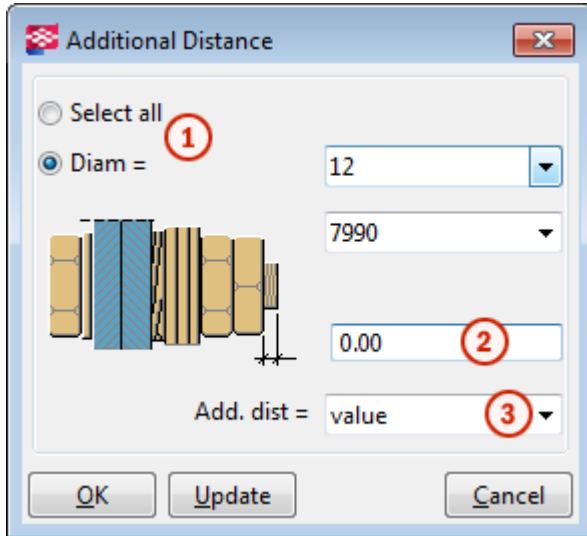

- ① Select whether the value of the additional length affects all or individual diameters of one bolt assembly.
- ② Enter the additional length value.
- ③ Select whether the value is absolute or relative to the diameter.

See also

[Add a bolt assembly to the catalog \(page 234\)](#)

5.11 Customize the rebar catalog

The rebar catalog contains definitions for different reinforcement types, such as reinforcing bars and strands of different grades.

The rebar catalog shows standard, environment-specific reinforcing bars and strands of the environment (or environments) that you have installed and that is currently open. The blank project environment only contains undefined reinforcing bars and strands.

You can add, copy, group, modify, and delete rebar definitions. You can also import and export single definitions, groups of definitions, or entire rebar catalogs.

Tekla Structures stores the rebar catalog information in the `rebar_database.inp` file that is by default saved to the current model folder.

Reinforcement meshes are not included in the rebar catalog. Standard meshes are defined in their own [catalog file \(page 321\)](#), `mesh_database.inp`.

Work with definitions in the rebar catalog

You can add, copy, modify, and delete rebar definitions in the rebar catalog.

To use the newly added or modified rebar definitions in the model, reopen the model.

Add a new rebar definition

You can add new definitions to the rebar catalog by defining the bar properties from scratch.

1. On the **File** menu, click **Catalogs** --> **Rebar catalog** to open the **Rebar catalog** dialog box.



2. Click **New bar**.

3. In the **New bar** dialog box, enter the bar properties.

If a property is shown in red, it is missing a value or has a value that is not valid. For example, **Grade** and **Size** must have a value.

4. Click **Add**.



5. Click **Save** to save the changes to the rebar catalog.

Add a new rebar definition by copying

You can add new definitions to the rebar catalog by copying an existing definition and then modifying it.

1. On the **File** menu, click **Catalogs** --> **Rebar catalog** to open the **Rebar catalog** dialog box.

2. Browse for and select the definition that you want to copy.



3. Click **Copy**.

Alternatively, you can right-click and select **Copy**.

4. In the **Copy** dialog box, enter or modify the bar properties.

Modify the property values that are shown in red so that the new definition is not a duplicate of the original definition.

5. Click **Add**.



6. Click **Save** to save the changes to the rebar catalog.

Select rebar definitions

You can use the following methods when you select rebar definitions in the **Rebar catalog** dialog box.

Selecting different sets of definitions is useful when you want to [export \(page 251\)](#) or [add tags \(page 256\)](#) to certain definitions, or otherwise modify a sub-set of definitions.

- Use the following commands on the catalog ribbon:
 - Click **Select all** to select all the definitions in the currently visible group. Alternatively, you can select one definition and then press **Ctrl+A**.
 - Click **Select none** to clear the current selection.
 - Click **Invert selection** to select the currently unselected definitions and to deselect the currently selected definitions.
- To select several consecutive definitions, select the first definition, then hold down **Shift** and select the last definition.
- To select several non-consecutive definitions, select the first definition, then hold down **Ctrl** and select the other definitions.

Modify a rebar definition

1. On the **File** menu, click **Catalogs** --> **Rebar catalog** to open the **Rebar catalog** dialog box.

2. Browse for and select the definition that you want to modify.

To modify several definitions, hold down **Ctrl** or **Shift** when you [select \(page 248\)](#).

3. In the property area on the right side of the **Rebar catalog** dialog box, modify the bar properties.

For example, you can select whether the bar is a main bar, or a tie or stirrup. You may also want to [add tags \(page 256\)](#) to the bar.

If a property is shown in red, it is missing a value or has a value that is not valid. For example, **Grade** and **Size** must have a value.



4. Click **Save** to save the changes to the rebar catalog.

Delete rebar definitions

1. On the **File** menu, click **Catalogs** --> **Rebar catalog** to open the **Rebar catalog** dialog box.

2. [Select \(page 248\)](#) one or more rebar definitions.

3. Right-click and select **Delete**.

- Click **Yes** to confirm the deletion.



- Click **Save** to save the changes to the rebar catalog.

Work with groups in the rebar catalog

In the rebar catalog, the rebar definitions are arranged to groups. You can add, copy, modify, and delete groups, and arrange the groups according to different properties. The groups are listed on the left side of the **Rebar catalog** and **Select rebar** dialog boxes.

STAR	CODE	GRADE	SIZE	USAGE	NOMINAL	ACTUAL	BENDING
*	B4	A500HW	6	main	6.00	8.00	72.00
*	B4	A500HW	6	tie/stirrup	6.00	8.00	12.00
*	B4	A500HW	8	main	8.00	10.00	96.00
*	B4	A500HW	8	tie/stirrup	8.00	10.00	16.00
*	B4	A500HW	10	main	10.00	12.00	120.00
*	B4	A500HW	10	tie/stirrup	10.00	12.00	20.00
*	B4	A500HW	12	main	12.00	14.00	144.00
*	B4	A500HW	12	tie/stirrup	12.00	14.00	30.00

By default, the definitions in the rebar catalog are grouped according to reinforcement grades. You can [change how the definitions are grouped \(page 253\)](#) in the **Rebar catalog** dialog box or in the **Select rebar** dialog box.

To use the newly added or modified rebar definition groups in the model, reopen the model.

Add a new group to the catalog

You can create new groups in the rebar catalog by copying an existing group and the definitions contained in it.

- On the **File** menu, click **Catalogs** --> **Rebar catalog** to open the **Rebar catalog** dialog box.

2. On the left side of the dialog box, select a group, and then click  **Copy**.
Alternatively, you can right-click a group and select **Copy**.
3. In the **New group name** dialog box, enter a name for the new group, and then click **Copy**.
Tekla Structures adds the new group to the catalog.
4. [Add, modify, and delete definitions \(page 247\)](#) contained in the new group as needed.

5. Click  **Save** to save the changes to the rebar catalog.

Modify a group in the catalog

1. On the **File** menu, click **Catalogs** --> **Rebar catalog** to open the **Rebar catalog** dialog box.
2. Select the group that you want to modify.
3. Select all definitions in the group.
4. In the property area on the right side of the **Rebar catalog** dialog box, modify the group properties.
For example, you can change the grade or cranked length type. You may also want to [add tags \(page 256\)](#) to all definitions in the group.

5. Click  **Save** to save the changes to the rebar catalog.

Delete a group from the catalog

You can delete groups and the definitions contained in them from the rebar catalog.

1. On the **File** menu, click **Catalogs** --> **Rebar catalog** to open the **Rebar catalog** dialog box.
2. Select a group from the list on the left side of the dialog box.
3. Right-click and select **Delete**.
4. Click **Yes** to confirm the deletion.

5. Click  **Save** to save the changes to the rebar catalog.

Import and export rebar definitions

Use importing and exporting for merging rebar definitions across different catalogs, models, and Tekla Structures environments and versions. To use reinforcing bars and strands in other Tekla Structures models, you can export rebar definitions to a file (*.inp), and then import the file into another Tekla Structures model.

TIP You can also download or share rebar catalog content using Tekla Warehouse.

Import definitions to the rebar catalog

You can customize the rebar catalog by importing rebar definitions from an .inp file.

1. Open the model to which you want to import rebar definitions.
2. On the **File** menu, click **Catalogs** --> **Rebar catalog** to open the **Rebar catalog** dialog box.

3. Click  **Import**.

4. In the **Import rebar definitions** dialog box, browse for the folder that contains the import file, select the file, and then click **Open**.

Tekla Structures checks if there are duplicates in the definitions in the import file compared to the rebar catalog.

5. If rebar definitions with the same properties as the definitions being imported already exist in the rebar catalog, a confirmation dialog box appears and you have the following three options:
 - Click **Overwrite** to replace all existing definitions with the newly imported definitions.
 - Click **Keep existing** to discard the duplicate definitions being imported and to only import the new definitions.
 - Click **Cancel** to not to import any definitions.

6. Click  **Save** to save the changes to the rebar catalog.

7. To use the newly imported definitions in the model, reopen the model.

Export definitions from the rebar catalog

You can export all or selected rebar definitions, or a selected group of a rebar catalog to a file (.inp).

1. Open the model from which you want to export rebar definitions.

2. On the **File** menu, click **Catalogs --> Rebar catalog** to open the **Rebar catalog** dialog box.

3. Do one of the following:

- To export the entire catalog, click  **Export --> Export all**.
- To export a certain group only, select the group, right-click and select **Export**.
- To export certain definitions only, [select the definitions \(page 248\)](#) and

then click  **Export --> Export selected**.

Alternatively, you can right-click on one of the selected definitions and then select **Export**.

4. In the **Export as** dialog box, browse for a folder, enter a name for the export file, and then click **Save**.

By default, Tekla Structures saves the file to the current model folder.

The file name extension is `.inp`.



Organize the rebar catalog view

You can organize the rebar catalog view in the **Rebar catalog** dialog box to suit your needs and ways of working. For example, you can change how the rebar definitions are grouped, hide certain property columns, or change the order of the property columns. You can also filter definitions and mark them with stars and tags.

Some of these methods work the same way also in the **Select rebar** dialog box; grouping by some of the properties, showing and hiding property columns, changing the order of the columns, filtering, and starring. The **Select rebar** dialog box opens when you click the **...** button next to the **Size** box in a reinforcement object's properties, or in a component dialog box to select a rebar definition.

The status bar at the bottom of the **Rebar catalog** and **Select rebar** dialog boxes shows useful information, such as:

- The number of definitions in the selected group.
- The property by which the definitions are grouped.
- The property by which the definitions are sorted.

The arrow symbol indicates if the sort order is ascending  or descending .

In the **Rebar catalog** dialog box, the status bar also shows the number of the selected definitions.

The changes you make to the dialog box layout are automatically saved to the `rebar_catalog.settings.UI` file in the `..\Users\<user>\AppData\Local\Trimble\Tekla Structures\<version>\Catalogs\` folder. Tekla Structures will use the saved layout next time you open the dialog box.

Show or hide the catalog ribbon

If needed, you can show or hide the ribbon in the **Rebar catalog** dialog box and in the **Select rebar** dialog box.

By default, the ribbon is shown in the **Rebar catalog** dialog box, but hidden in the **Select rebar** dialog box.

- To show the ribbon, click the down arrow ▼ at the right end of the **(Home)** ribbon title bar.
- To hide the ribbon, click the up arrow ▲ at the right end of the **(Home)** ribbon title bar.

Change the grouping of rebar definitions

You can select the property by which the rebar definitions are grouped in the rebar catalog. By default, the rebar definitions are grouped by grade.

1. On the **File** menu, click **Catalogs --> Rebar catalog** to open the **Rebar catalog** dialog box.

Alternatively, you can use the **Select rebar** dialog box.

2. Click  **Group by**, and then select the property by which you want to group the rebar definitions.

For example, you can select **Size** or **Cross section area**.





The definitions can also be grouped by a property whose property column is not visible.

The properties that are available may vary in the **Rebar catalog** and **Select rebar** dialog boxes.

Work with property columns in the catalog view

You can organize the rebar catalog view in the **Rebar catalog** dialog box and in the **Select rebar** dialog box by showing and hiding the property columns, and by changing the order, sort order, and width of the columns.

The **Star** column is always visible and you cannot hide it.

To	Do this
Show or hide a property column	<ol style="list-style-type: none"> 1. Click  Show columns to open a list of the available property columns. A check mark in front of a column name indicates that the column is visible. 2. To show a column, click the column name to add a check mark in front of the column name. 3. To hide a column, click the column name to remove the check mark.
Change the order of the property columns	Drag a column header to a new location.
Change the sort order of a property column	<p>Click the column header.</p> <p>The arrow symbol next to the column header indicates if the sort order is ascending  or descending .</p> <p>To sort values by two properties and in two columns:</p> <ol style="list-style-type: none"> 1. Sort by one column. 2. Hold down Shift and then sort by the other column.
Resize a property column	<p>Drag the edge between this and the following column header. For example:</p> <div data-bbox="852 1473 1066 1518" style="border: 1px solid gray; padding: 2px; display: inline-block;"> GRADE  SIZE </div> <p>You can also click  Fit columns to adjust the widths of the visible columns so that the longest value in each column (or the column header in the shape catalog) is shown. This does not affect the widths of the columns you have manually resized.</p>

Filter rebar definitions

You can filter rebar definitions in both the **Rebar catalog** dialog box and the **Select rebar** dialog box. You can use filtering together with the other methods, such as sorting, to narrow down the number of definitions shown in the rebar catalog view.

1. On the **File** menu, click **Catalogs --> Rebar catalog** to open the **Rebar catalog** dialog box.

Alternatively, you can use the **Select rebar** dialog box.

2. In the **Filter** box, enter the search term or filtering criteria.

For example, to find rebar definitions that are suitable for stirrups and ties, enter `tie`.

Tekla Structures shows the groups that contain matching definitions.

3. Select a group.

Tekla Structures shows the matching definitions in the group, for example, the definitions that have **Usage** set to **tie/stirrup**.

Add stars to rebar definitions

You can mark important or preferred rebar definitions with stars, so that you can easily find these definitions later. The definitions that are marked with yellow stars appear in the **Starred** group in the rebar catalog. Starring is user-specific, so it is only visible to you.

The starring settings are stored in the current model folder in the `rebar_catalog.settings.user.<username>` file, where the `<username>` suffix is your username.

If you have starred definitions, the **Rebar catalog** dialog box opens with the **Starred** group selected.

1. On the **File** menu, click **Catalogs --> Rebar catalog** to open the **Rebar catalog** dialog box.

Alternatively, you can use the **Select rebar** dialog box.

2. Browse or search for the definitions that you want to mark with stars.

3. In the definition list, click the white star symbol in the **Star** column for each definition that you want to add to the **Starred** group.

By default, the **Star** column is the first column and the star symbol is at the beginning of each definition row.

STAR	CODE	GRADE	SIZE
★	B4	A500HW	10

The star symbol turns yellow  and the definition is added to the **Starred** group.

4. To remove the starring from a definition, click the yellow star symbol on the definition row.

The star symbol turns white again and the definition is removed from the **Starred** group.

Add tags to rebar definitions

In the **Rebar catalog** dialog box, you can add tags to rebar definitions. You can use tags to add keywords or other metadata to the definitions.

For example, you could use tags like `Stainless` and `Acid proof`.

Tags are model-specific and saved to the `rebar_catalog.settings` file in the current model folder.

1. On the **File** menu, click **Catalogs** --> **Rebar catalog** to open the **Rebar catalog** dialog box.
2. [Select the definitions \(page 248\)](#) that you want to tag.
3. Enter the tag in the **Tags** box at the bottom-right corner of the **Rebar catalog** dialog box, and then press **Enter**.

To add several tags to a definition, enter the next tag in the next tag box and press **Enter**.

Each group of tagged definitions appears with the  symbol in the list of groups, after the **Starred** group:

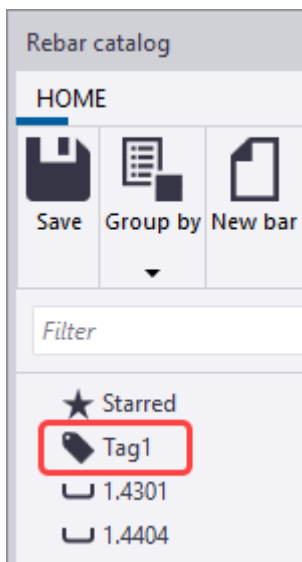

4. To remove a tag from a definition, select the definition and click the **X** symbol after the tag name in the **Tags** section in the property area.
5. To delete a tag completely, select the tagged group, select all the definitions in the group, and then click the **X** symbol after the tag name in the **Tags** section in the property area.

6. Click  **Save** to save the changes to the rebar catalog.

5.12 Customize the Applications & components catalog

You can modify the catalog definition settings of the **Applications & components** catalog using catalog definition files, and set up a group structure to suit the needs of your company. Always check the settings and the group structure when upgrading to a new Tekla Structures version.

Catalog definition files (`ComponentCatalog.xml`) can be located in folders pointed by `XS_SYSTEM`, `XS_FIRM`, `XS_PROJECT`, and in the model folder. If there are several catalog definition files, Tekla Structures combines the information in the files. For more information on the folder search order, see [Folder search order \(page 361\)](#).

When you create a group structure for the **Applications & components** catalog, define the highest level structure in a catalog definition file that is located in a folder pointed by `XS_SYSTEM`. To hide unnecessary parts of the group structure and catalog content from certain roles, edit the catalog definition files of these roles.

For general instructions on how to use the **Applications & components** catalog, see [How to use the Applications & components catalog](#).

You can also add your own instructor side pane help pages for the tools in the **Applications & components** catalog, see [Add instructor help for applications and components \(page 263\)](#).

Edit the catalog

1. Set the `XS_COMPONENT_CATALOG_ALLOW_SYSTEM_EDIT` advanced option to `TRUE` to edit the catalog definition files.
2. In the **Applications & components** catalog, click  **Access advanced features** --> **Catalog management** --> **Edit mode**, and select the catalog definition file that you want to edit.

The list of files shows all the environment folders, the project and firm folders if defined, and the model folder. You can define the needed catalog definition file folder paths in `XS_SYSTEM`.

If `XS_COMPONENT_CATALOG_ALLOW_SYSTEM_EDIT` is not set to `TRUE`, a small warning icon is shown next to the files in the `XS_SYSTEM` folder locations. The image shows warning icons next to the files that appear dimmed.

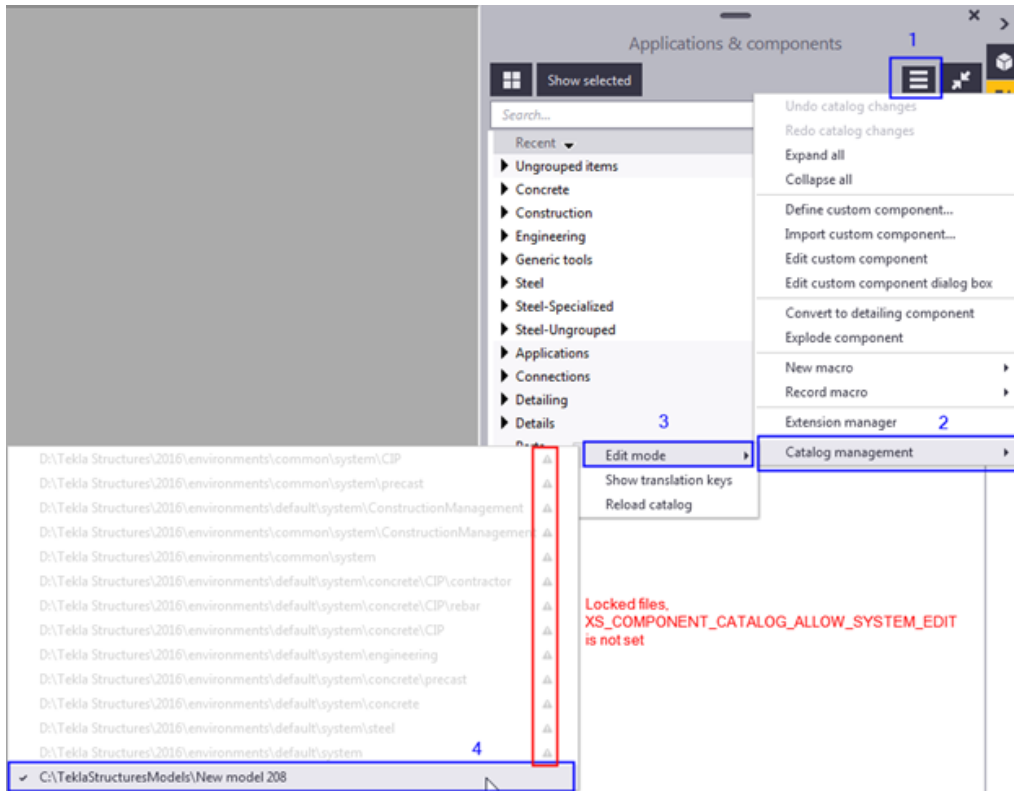

The files that appear dimmed do not exist, but you can create the files by selecting them, and answering **Yes** in the **Edit mode** message box.

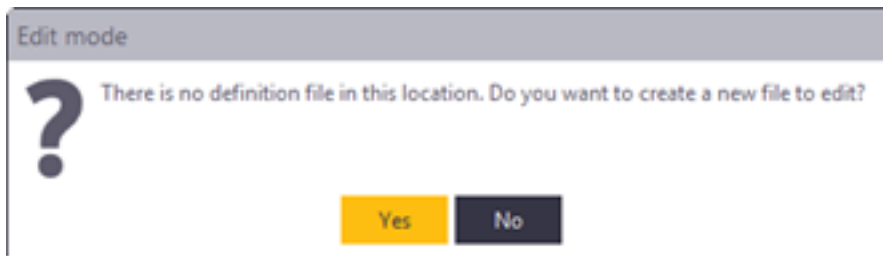

You can remove an existing file by clicking the **X** button next to the file.

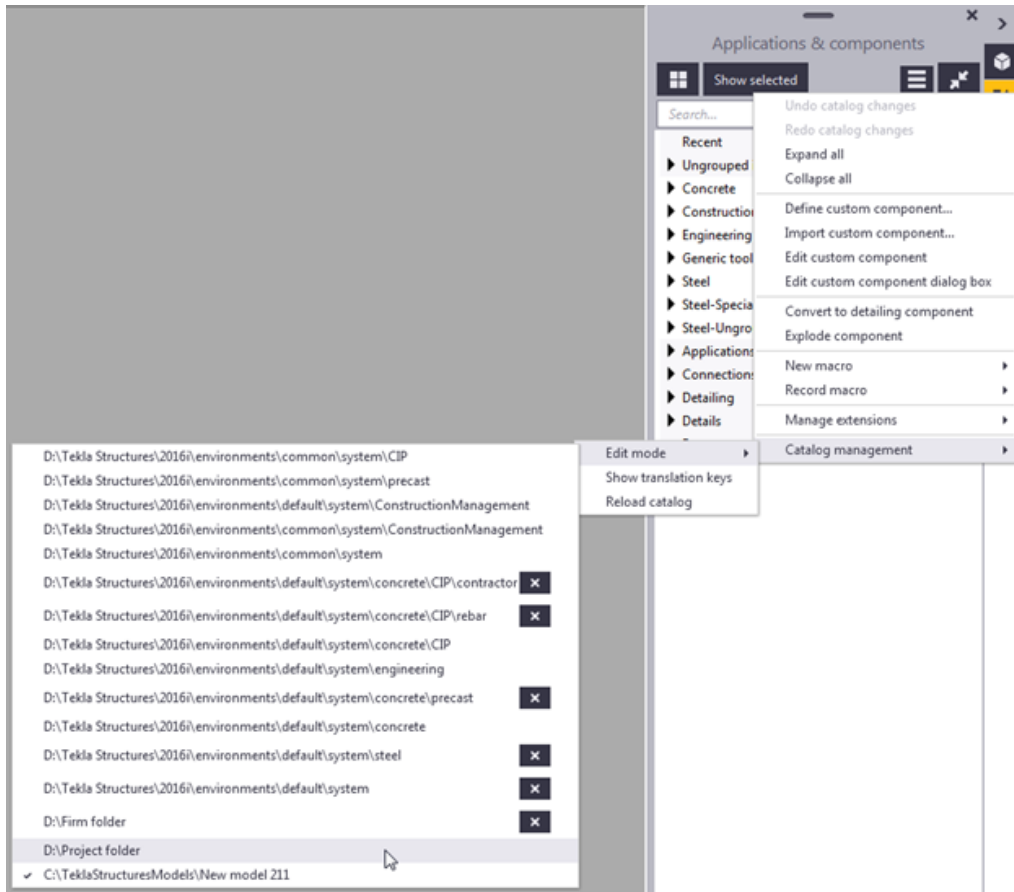

3. Select the file that you want to edit.

The check mark in front of the folder name shows the file that is currently being edited.

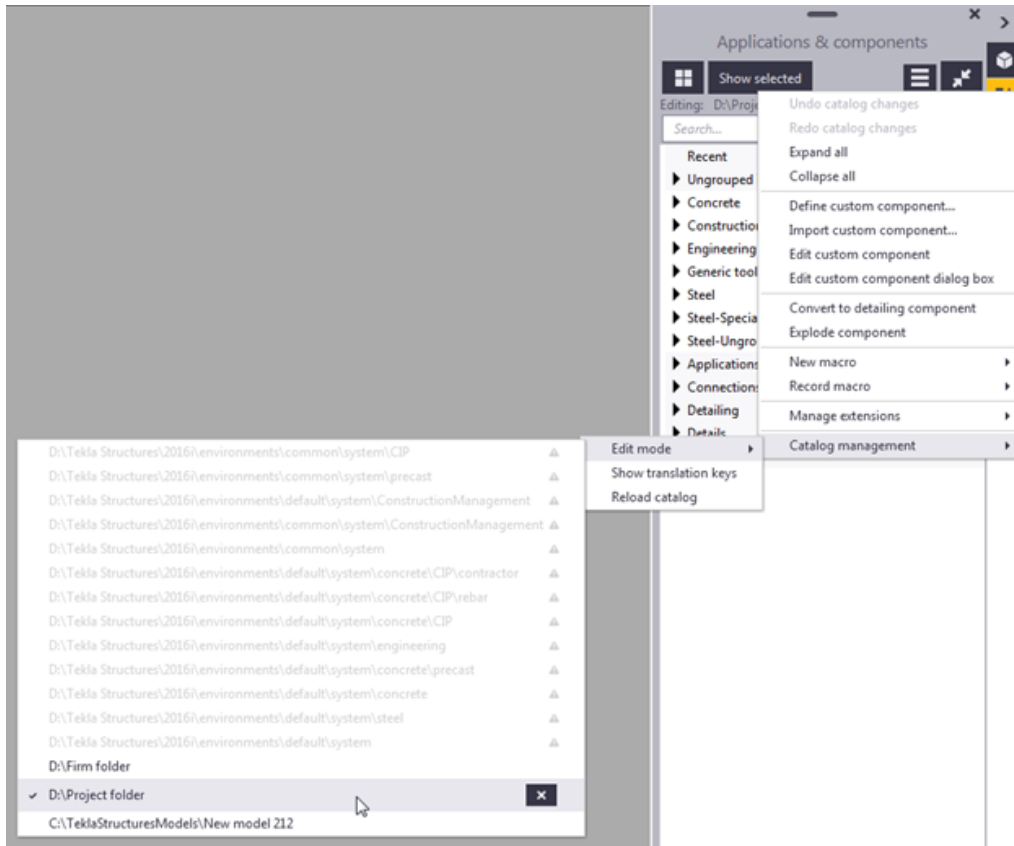

4. Create new groups and subgroups to organize the catalog content, right-click in the catalog and select **New group....**
5. Move the content from **Ungrouped items** to the new groups, or to other predefined custom groups. To move an item to another group, right-click the item, select **Add to group**, and then select the target group.

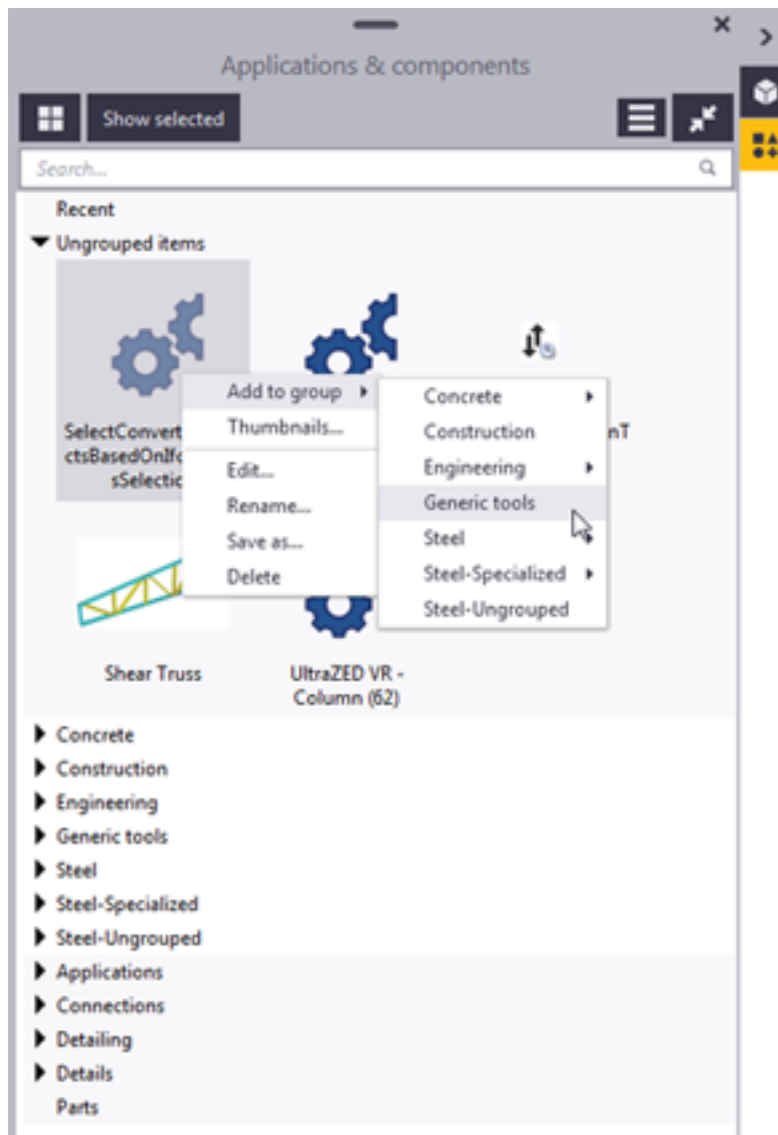

It is important to keep the **Ungrouped items** group empty, because all items downloaded from Tekla Warehouse are placed in that group. When you place an item to a predefined group, it is automatically removed from the ungrouped items.

For instructions on how to collect content to a group and publish it as a catalog definition file, see Publish a group in the Applications & components catalog.

Maintain the catalog

To keep the **Applications & components** catalog structure and content clear and in order, keep the groups up to date and organized, and remove the unnecessary items from the catalog definition files.

1. Click  in the bottom-right corner in the **Applications & components** catalog to display the message log:

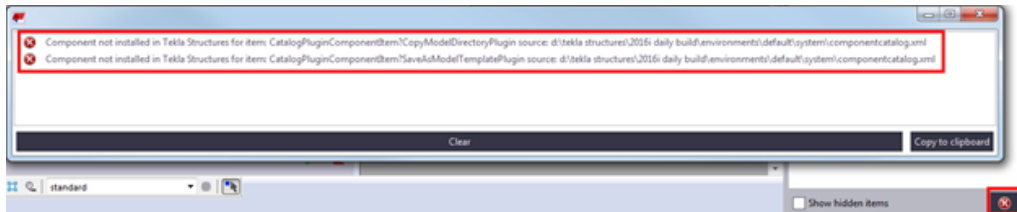

If an item defined in a catalog definition file is removed from the Tekla Structures software, the removed item will be included in the **Applications & components** catalog error message log.

2. If the log contains references to missing items, edit the relevant `ComponentCatalog.xml` file to remove the references manually.

We recommend that you make a back-up copy of the file before you start editing.



3. Test thoroughly that these changes do not create any further errors, or mess up the group structure in the **Applications & components** catalog. Check at least the **Ungrouped items** and **Legacy catalog** groups.
4. Newly added items are placed in the **Ungrouped items** group. If there are new items in the group, move them to the appropriate predefined groups, and hide them from specific roles, if needed.
5. Add suitable thumbnails to the items, if needed.

Troubleshooting components or groups in the catalog

If a component or group in the **Applications & components** catalog is not working as expected, you can generate a troubleshooting dump file that shows the data used to construct the component or group.

1. In the **Applications & components** catalog, click  **Access advanced features** --> **Catalog management** --> **Show dump command for selected component or group**.
2. In the catalog, select the component or group, then right-click and select **Dump troubleshooting data**.
3. In the dialog box that opens, select the target file path and enter the file name, then click **Save** to save the file.

By default, the file is stored in the `\local\temp` folder for the model.

5.13 Add instructor help for applications and components

You can easily create side pane help for tools in the **Applications & components** catalog.

In the **Applications & components** catalog, the **Instructor** shows content already on selection, so the information is especially useful for giving advice to your users on choosing between different components or giving instructions before running a tool. To make full use of this feature, users should arrange their side panes so that both panes are visible.

1. Select the tool you want to add help for in the **Applications & components** catalog.
2. Click the **Add help files** button in the **Instructor** pane.

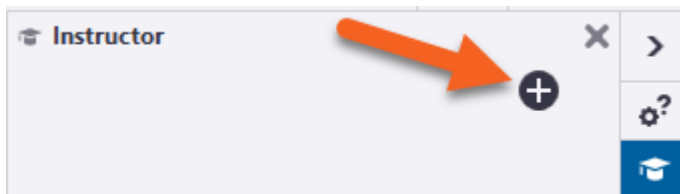

A dialog box opens for creating the necessary files according to your selections.

3. Click **Next** and select the languages that are used as user interface languages in your organization. There needs to be a content file for each language even if you do not translate the content.
4. Click **Next** and select the folder where you want to store the generated files. The files can be stored in the model, project, firm, or system folder. The standard [folder search order \(page 361\)](#) is followed.
5. Click **Create**.

Tekla Structures creates an XML file that defines a link between the tool in the **Applications & components** catalog and an HTML file for the help content.

The HTML files are stored in a folder structure that separates files into language-specific folders. The XML file and the root folder for the content are named according to the identifier of the tool you are documenting. You can copy files between the allowed storage locations, but do not rename the files or folders or change the folder structure.

6. Edit the HTML content file(s) in your preferred tool, such as a text editor, or replace the file with your own HTML file of the same name. If you do not have any HTML editing experience, there are several good tutorials available on the internet to quickly learn the few basics you need to know. You can create your own HTML files by saving as HTML from familiar tools, such as Microsoft Word or Google Docs. Note that the resulting files will not look exactly the same as the original document.

6 Files and folders in Tekla Structures

Sometimes you need to know where Tekla Structures stores information, and the types of files that Tekla Structures contains, where the files are located, and how the files should be should be used.

Tekla Structures contains a large amount of files that affect the way the software works. It is important to know which file controls which functionality, and also which files we do not recommend that you touch.

The initialization file reading order is also very important. You need to know the order in which the files are read when you open Tekla Structures, so that you do not modify the files unnecessarily.

See also

[Initialization files \(.ini files\) \(page 271\)](#)

[Input files \(.inp files\) \(page 302\)](#)

[File storing options and advanced options \(page 279\)](#)

[Data files \(.dat files\) \(page 316\)](#)

[Message files \(page 317\)](#)

[Standard files \(page 319\)](#)

[Property files \(page 318\)](#)

[Catalog files \(page 321\)](#)

[Font files and font conversion files \(page 324\)](#)

[Symbol files \(page 325\)](#)

[Image files \(page 326\)](#)

[Files related to templates, reports and drawings \(page 325\)](#)

[Log files \(page 327\)](#)

[Model folder files and file name extensions \(page 336\)](#)

[Check and change Tekla Structures file and folder locations in Directory browser \(page 361\)](#)

[Folder search order \(page 361\)](#)

[Create project and firm folders \(page 266\)](#)

[Location of certain hidden files and folders \(page 364\)](#)

6.1 Create project and firm folders

Use project and firm folders for customized files. These can be custom ribbons, drawing styles, profile and material catalogs, or any other settings you want to store for future use. You can use the same files each time you start a new model or install a new version of Tekla Structures. This also means you can easily revert back to the default settings, because you have not overwritten any of the system files.

Use the **project folder** and its sub-folders to store customized files that are only used in a particular project. A project may consist of several models done by separate teams, all spread out in different locations. You can save project-specific files and settings in the project folder, so that everyone in the project can use them. A project may also consist of one model that is shared by different companies.

Use the **firm folder** and its sub-folders to store customized files for the entire organization or company. The settings and files in the firm folder are meant to be used in all projects within the company. For example, let's say you regularly work for a company that has specific drawing layout standards it expects you to use. Customize the drawing templates once for the company and save them in the firm folder or in a sub-folder of the firm folder. You can then use the customized drawing templates for all future projects for that company.

When working within one company, the firm and project folders are usually located in network folders so that everyone can access them. In collaborative projects that include multiple teams or companies, you can use a folder in the linked .

Project and firm folders are defined by `XS_FIRM` and `XS_PROJECT`. When working in a model sharing project, each company needs to have its own firm settings in a folder defined by `XS_FIRM`, and a common project folder for project settings defined by `XS_PROJECT`. It may be useful to create a [startup shortcut \(page 21\)](#) on your desktop for each project containing all necessary folders.

WARNING Changing an advanced option value in `.ini` files located outside the model folder does not affect the existing models. You can only update advanced options in the **Advanced Options** dialog box or in the `options.ini` file located in model folder; not from an `options.ini` file located in folders defined for the advanced options `XS_FIRM` or `XS_PROJECT`. The `.ini` files are read also when you open an existing

model, but only new advanced options that do not exist in `options_model.db` or `options_drawings.db` are inserted, for example, such options that are not yet in the **Advanced Options** dialog box but have been added in the software.

Create a project or firm folder

1. Create an empty folder in a shared location, for example on a network drive.
2. Name the folder appropriately.
3. In Tekla Structures, go to the **File** menu and click **Settings** --> **Advanced options**.
4. In the **File Locations** category, define the path to the firm or project folder you created in step 1 for the advanced option `XS_FIRM` or `XS_PROJECT`.
5. Restart Tekla Structures for the change to take effect.

See also

[Folder search order \(page 361\)](#)

[Typical initialization files \(.ini files\) and their reading order \(page 271\)](#)

Fixed sub-folders in project and firm folders

Some files need to be stored in particular, or *fixed*, sub-folders under project and firm folders. If the files are not stored in these folders, Tekla Structures cannot read the files. See the files which should be stored in fixed sub-folders in the following table.

XS_FIRM or XS_PROJECT sub-folder	Further sub-folders and necessary files	See also
<code>\AdditionalPsets</code>	Use this folder to store additional property set configuration files for IFC export in the <code>.xml</code> format.	<ul style="list-style-type: none"> • Property set configuration files used in IFC export
<code>\CustomInquiry</code>	Use this folder to store: <ul style="list-style-type: none"> • report templates for custom inquiries as <code>.it</code> files • the <code>InquiryTool.config</code> file for defining which attributes are included by default in the Manage 	<ul style="list-style-type: none"> • Custom inquiry

XS_FIRM or XS_PROJECT sub-folder	Further sub-folders and necessary files	See also
	<p>content dialog box for selecting the properties shown in custom inquiries</p>	
\Drawing Details	<p>Use this folder to store 2D drawing details as .ddf and .png files.</p> <p>Note that to see the drawing details stored in the \Drawing Details sub-folder under a firm or project folder in Tekla Structures:</p> <ol style="list-style-type: none"> 1. In the Drawing 2D library side pane, click the  Folder button. 2. Select Firm or Project. 	<ul style="list-style-type: none"> • 2D Library in drawings
\macros	<p>This sub-folder has the following sub-folders:</p> <ul style="list-style-type: none"> • \Drawings Use this folder to store macros related to drawings as .bmp, .cs, and .cs.pdb files. • \Modeling Use this folder to store macros related to modeling as .bmp, .cs, and .cs.pdb files. <p>Note that macros are primarily read from the folder defined by the XS_MACRO_DIRECTORY advanced option. This advanced option can point to any folder, not just the \macros sub-folder of a firm or project folder.</p>	<ul style="list-style-type: none"> • Working with applications • XS_MACRO_DIRECTORY
\profil	<p>This sub-folder can have the following sub-folders:</p> <ul style="list-style-type: none"> • \ShapeGeometries Use this folder to store shape geometry descriptions as .tez or .xml files. • \Shapes Use this folder to store shape descriptions as .xml files. 	<ul style="list-style-type: none"> • Customize the shape catalog (page 210)

XS_FIRM or XS_PROJECT sub-folder	Further sub-folders and necessary files	See also
\ProjectOrganizerData	<p>This folder has the following sub-folders:</p> <ul style="list-style-type: none"> • \DefaultCategoryTrees Use this folder to store Organizer categories as .category files. • \PropertyTemplates Use this folder to store property templates from Organizer as .propertytemplate files. • \ExcelTemplates Use this folder to store customized templates in .xlt format for exporting object property values from Organizer. 	<ul style="list-style-type: none"> • Customized default setup for Organizer
\PropertyRepository \Templates	<p>Use this folder to store customized property pane layouts in the PropertyTemplates.xml file.</p>	<ul style="list-style-type: none"> • Distribute customized property pane layouts by using a project, firm, or environment folder (page 137)
\Symbols	<p>Use this folder to store:</p> <ul style="list-style-type: none"> • symbols as .sym and .dwg files • other images and bitmaps used in drawings <p>Note that symbols are primarily read from the folder defined by the DXK_SYMBOLPATH advanced option. This advanced option can point to any folder, not just the \Symbols sub-folder of a firm or project folder.</p>	<ul style="list-style-type: none"> • Add symbols in drawings • DXK_SYMBOLPATH
\template	<p>Use this folder to store graphical templates used in drawing layouts as .tpl files.</p> <p>Note that templates are primarily read from the folder defined by the</p>	<ul style="list-style-type: none"> • XS_TEMPLATE_DIRECTORY • XS_TEMPLATE_MARK_SUB_DIRECTORY

XS_FIRM or XS_PROJECT sub-folder	Further sub-folders and necessary files	See also
	<p>XS_TEMPLATE_DIRECTORY advanced option.</p> <p>In the same way, the <code>tpled.ini</code> is primarily read from the folder defined by the XS_TPLED_INI advanced option.</p> <p>These advanced options can point to any folder, not just the <code>\Template</code> sub-folder of a firm or project folder.</p> <p>This folder also contains the following sub-folders:</p> <ul style="list-style-type: none"> • <code>\mark</code> <p>Use this folder to store graphical templates used in drawing marks.</p> <p>Note that templates used in drawing marks are primarily read from the folder defined by the XS_TEMPLATE_MARK_SUB_DIRECTORY folder. This advanced option can point to any folder, not just the <code>\template\mark</code> sub-folder of a firm or project folder.</p> • <code>\settings</code> <p>Use this folder to store the <code>tpled.ini</code> file, which defines environment-specific template settings, and the user-defined attributes (UDAs) related to Template Editor in the <code>contentattributes_user-defined_YOUR_COMPANY.lst</code> file.</p> <p>Note that to read Template Editor files from the <code>template\settings</code> sub-folder within a firm or project folder, the XS_TEMPLATE_DIRECTORY_SYSTEM advanced option needs to point to the <code>\.ini</code> sub-folder in the firm or project folder.</p> 	

6.2 Initialization files (.ini files)

Initialization files are used for defining Tekla Structures start-up parameters and default settings. They contain advanced options that are used for configuring Tekla Structures for different standards, and for your or your company's style of working.

Tekla Structures automatically creates the necessary [initialization files](#) (page 271) during installation. The number of initialization files it creates depends on how many Tekla Structures environments you have installed.

NOTE You can also define switches for advanced options in .ini files. In this case, you need to use double percent signs around the switch %%xxx%. When you define a switch in the **Advanced Options** dialog box, you only use single percent signs around the switch %xxx%. For example, type %%BOLT_NUMBER%*D%HOLE.DIAMETER%% for the advanced option XS_BOLT_MARK_STRING_FOR_SIZE when you define it in an .ini file.

See also

[Global default environment settings - env_global_default.ini](#) (page 276)

[Local environment settings - env_<environment>.ini](#) (page 276)

[Role settings - role_<role>.ini](#) (page 277)

Typical initialization files (.ini files) and their reading order

Below is a list of all the typical initialization files that are read when Tekla Structures is started. The numbers indicate their reading order at startup. If there are conflicting settings, the ones read later override the ones read earlier.

WARNING Changing an advanced option value in .ini files located outside the model folder does not affect the existing models. You can only update advanced options in the **Advanced Options** dialog box or in the options.ini file located in model folder; not from an options.ini file located in folders defined for the advanced options XS_FIRM or XS_PROJECT. The .ini files are read also when you open an existing model, but only new advanced options that do not exist in options_model.db or options_drawings.db are inserted, for example, such options that are not yet in the **Advanced Options** dialog box but have been added in the software.

NOTE When you define a switch for an advanced options in an .ini file, you need to use double percent signs around the switch %%xxx%. When

you define a switch in the **Advanced Options** dialog box, you only use single percent signs around the switch %xxx%. For example, type %BOLT_NUMBER%%*D%%HOLE.DIAMETER%% for the advanced option XS_BOLT_MARK_STRING_FOR_SIZE when you define it in an .ini file.

To check the files that have been read and their reading order, go to **File menu --> Logs --> Session history log**.

File and reading order	Description
<p>1. fonts_<lang>.ini</p>	<p>This file is optional, and it is only needed for languages using special characters. One example is the fonts_jpn.ini file for the Japanese language.</p> <p>This file is read from Tekla Structures\<version>\bin\ if it is available. It is installed to the ..\bin folder when Tekla Structures is installed.</p> <p>NOTE: Do not change these settings.</p>
<p>2. teklastructures.ini</p>	<p>The file teklastructures.ini starts Tekla Structures. It is read from ..\Program Files\Tekla Structures\<version>\bin\.</p> <p>This file contains basic system settings, such as the location of software and environment files. This file is installed to the ..\bin folder when Tekla Structures is installed. It is always read at Tekla Structures startup.</p> <p>NOTE: Do not change these settings.</p>
<p>3. lang_<lang>.ini</p>	<p>This file contains the language settings. It is read from ..\Program Files\Tekla Structures \<version>\bin\.</p> <p>This file is installed to the ..\bin folder when Tekla Structures is installed.</p> <p>Which lang_<lang>.ini files exist in the ..\bin folder depends on which languages you have selected to</p>

File and reading order	Description
	<p>install during the software installation.</p> <p>The language that is read depends on the language you have selected in File menu --> Settings --> Change language in the previous Tekla Structures session.</p> <p>NOTE: Do not change these settings.</p>
4. env_global_default.ini	<p>This file is used as a default for all environments and contains the global settings. The settings in the env_global_default.ini file provide the basics for all environment settings globally. The settings in this file can be localized and specified differently in an environment-specific initialization file that is read later than this file.</p> <p>This file is always read at Tekla Structures startup from ..\ProgramData\Trimble\Tekla Structures\<version>\environments\common\ and is installed there from the common environment installation package.</version></p> <p>NOTE: Do not change these settings.</p>
5. All .ini files defined in shortcut/command line with -I <name>.ini	Usually none.
6. env_<environment>.ini	<p>The env_<environment>.ini files contain all the advanced options that have environment-specific settings. They are read from the environment folder ..\ProgramData\Trimble\Tekla Structures\<version>\environments\. The exact location may vary depending on your environment.</version></p> <p>The env_<environment>.ini files that exist on your computer depends on which environment packages you have installed. Which env_<environment>.ini file is read depends on the environment that you</p>

File and reading order	Description
	<p>select in the Tekla Structures startup dialog box.</p> <p>NOTE: Do not change these settings.</p>
<p>7. <code>role_<role>.ini</code></p>	<p>The <code>role_<role>.ini</code> files contain all the advanced options that have typical role-specific settings. They are read from the environment folder <code>..\ProgramData\Trimble\Tekla Structures\<version>\environments\</code>. The exact location may vary depending on your environment.</p> <p>The available roles depend on the environments you have installed.</p> <p>You can select the role in the Tekla Structures startup dialog box.</p> <p>For example, this file defines that the US environment imperial role uses imperial units, shows the fractions correctly, and understands input as imperial. In US environment metric role metric units are used.</p> <p>NOTE: Do not change these settings.</p>
<p>8. All <code>.ini</code> files defined in shortcut/command line with <code>-i <name>.ini</code></p>	<p>Usually none.</p>
<p>9. <code>company.ini</code></p>	<p>The <code>company.ini</code> file is useful especially for big companies that want to unify certain enterprise-level settings. This file is read from a folder specified with the advanced option <code>XS_COMPANY_SETTINGS_DIRECTORY</code>. This file is read only if the advanced option <code>XS_COMPANY_SETTINGS_DIRECTORY</code> is set.</p> <p>This file is created by the system administrator when necessary, it is not created by the installation.</p>
<p>10. <code>user.ini</code></p>	<p>The <code>user.ini</code> file is where you can save your personal user settings.</p> <p>This file is located in the same location as the user-specific <code>options.bin</code> file, for example,</p>

File and reading order	Description
	<p>C:\Users\<user>\appdata\local\trimble\tekla p="" structures\<version>\usersettings.<=""> <p>The user.ini is created in the above mentioned location when you start Tekla Structures for the first time and create and save a model using the current version. It is read when you start Tekla Structures.</p> <p>The changes you make in the advanced options in the Advanced Options dialog box override the settings in all other initialization files, if the advanced option exists in both locations.</p> <p>If user.ini has system options they are read always when Tekla Structures is opened.</p> <p>If user.ini has model-specific options they are used when new model is created.</p> <p>If user.ini has user-specific options they are used when Tekla Structures is used for the first time.</p> </user>\appdata\local\trimble\tekla></p>
11. options.ini in system folder	The folder is specified with the advanced option XS_SYSTEM.
<p>12. options.ini, firm-specific, if any exist</p> <p>13. options.ini, project-specific, if any exist</p>	<p>The option.ini files containing firm- or project-specific model settings are saved in and read from user-defined locations specified with the advanced options XS_FIRM and XS_PROJECT. They work in the specified way for the firm in question, or for the specified project if the model has been set up to read settings from these locations, and if the user has manually moved the options.ini file to these locations. An options.ini is created in the firm or project folder when you copy or move it there.</p> <p>Updating of model-specific and user-specific advanced options can only be done from the Advanced Options</p>

File and reading order	Description
	dialog box or <code>options.ini</code> located in model folder, not from the firm- or project-specific <code>options.ini</code> files. The <code>options.ini</code> in the firm or project folder is read when you start Tekla Structures or open the model.
14. <code>options.ini</code> , model-specific	The <code>options.ini</code> in the model folder.

See also

[Create start-up shortcuts with customized initializations \(page 21\)](#)

[Settings defined by advanced options \(page 299\)](#)

Global default environment settings - `env_global_default.ini`

The `env_global_default.ini` file defines the global defaults for advanced options. The file is read from `..\ProgramData\Trimble\Tekla Structures\<version>\environments\common\`.

WARNING Do not modify the `env_global_default.ini` file. If you need to modify some environment settings, copy the needed advanced options from this file to your [user.ini \(page 277\)](#) file and modify the settings there, or modify the settings in the **Advanced Options** dialog box.

For advanced options that are set according to your local standards, see the environment settings file [env_<environment name>.ini \(page 276\)](#) and the role settings file [role_<role name>.ini \(page 277\)](#). The local files override the advanced options set in `env_global_default.ini`.

If the advanced option in the `env_global_default.ini` file is preceded by `rem`, the software defaults are used and shown as the value. The outdated advanced options are listed at the end of the file.

See also

[Typical initialization files \(.ini files\) and their reading order \(page 271\)](#)

Local environment settings - `env_<environment>.ini`

The `env_<environment>.ini` file contains advanced options that are set according to local standards and are different from the global defaults. The file is read from the environment folder `..\ProgramData\Trimble\Tekla`

Structures\<>version>\environments\. The exact location may vary depending on your environment.

WARNING Do not modify the `env_<environment>.ini` file. If you need to modify some settings, copy the needed advanced options from this file to your [user.ini \(page 277\)](#) file and modify the settings there, or modify the settings in the **Advanced Options** dialog box.

The global default environment settings file [env_global_default.ini \(page 276\)](#) contains a complete listing of advanced options. The local files override the advanced options set in `env_global_default.ini`.

See also

[Typical initialization files \(.ini files\) and their reading order \(page 271\)](#)

Role settings - `role_<role>.ini`

The `role_<role>.ini` files contain all the advanced options that have typical role-specific settings. The file is read from the environment folder `..\ProgramData\Trimble\Tekla Structures\<>version>\environments\`. The exact location may vary depending on the environment.

WARNING Do not modify the `role_<role>.ini` file. If you need to modify some settings, copy the needed advanced options from this file to your [user.ini \(page 277\)](#) file and modify the settings there, or modify the settings in the **Advanced Options** dialog box.

The `role_<role>.ini` file contains advanced options that are set according to typical role requirements in your local area. These settings are different from your environment settings in [env_<environment name>.ini \(page 276\)](#). The global default environment settings file [env_global_default.ini \(page 276\)](#) contains a complete listing of advanced options. The advanced option settings in `role_<role>.ini` override the ones in `env_<environment>.ini`

See also

[Typical initialization files \(.ini files\) and their reading order \(page 271\)](#)

Add an advanced option to the user.ini file

You can save your personal user settings to the `user.ini` file. The `user.ini` file is located in the same location as the user-specific `options.bin` file, for

example, `..\Users\\AppData\Local\Trimble\Tekla Structures\\UserSettings`.

NOTE We recommend that you add only [system-specific \(page 299\)](#) advanced options to the `user.ini` file.

You can also add [model-specific \(page 299\)](#) advanced options, but the model-specific advanced options only affect new models that you create. This is because only the new advanced options that do not yet exist in `options_model.db` or `options_drawings.db` are taken into account. For more information, see [Files storing option and advanced options \(page 279\)](#).

Adding user-specific advanced options in `user.ini` may not work as desired as `options.bin` is loaded after `user.ini` and may override the value.

1. Right-click the `user.ini` file in Windows Explorer and select **Open with**. Select a standard text editor from the list of available programs.
2. On a new line, enter `set`, then a space, then the name of the advanced option followed by an equal sign, and then the value in a single line.
Tekla Structures only reads lines in the initialization file that start with `set`.
3. Save `user.ini`.
4. Restart Tekla Structures for the changes to take effect.

Possible values	Example
TRUE FALSE	<code>set XS_DISABLE_WELD_PREP_SOLID=TRUE</code> <code>set XS_UNDERLINE_AFTER_POSITION_NUMBER_IN_HARDSTAMP=FALSE</code>
1 0	<code>set XS_SINGLE_CLOSE_DIMENSIONS=1</code> <code>set XS_SINGLE_USE_WORKING_POINTS=0</code>
string value	<code>set XS_USER_DEFINED_BOLT_SYMBOL_TABLE=bolt_symbol_table.txt</code>
switches	<code>set XS_ASSEMBLY_FAMILY_POSITION_NUMBER_FORMAT_STRING=%%TPL:PROJECT.NUMBER%%</code> Use two switches.

TIP When you are moving to a new version of Tekla Structures, you can use the Migration Wizard to automatically copy your `user.ini` file to the

new version. The Migration Wizard appears once you start Tekla Structures for the first time after installation.

See also

[Location of certain hidden files and folders \(page 364\)](#)

[Typical initialization files \(.ini files\) and their reading order \(page 271\)](#)

6.3 File storing options and advanced options

WARNING Changing an advanced option value in `.ini` files located outside the model folder does not affect the existing models. You can only update advanced options in the **Advanced Options** dialog box or in the `options.ini` file located in model folder; not from an `options.ini` file located in folders defined for the advanced options `XS_FIRM` or `XS_PROJECT`. The `.ini` files are read also when you open an existing model, but only new advanced options that do not exist in `options_model.db` or `options_drawings.db` are inserted, for example, such options that are not yet in the **Advanced Options** dialog box but have been added in the software.

What happens at model creation

When a new model is created, Tekla Structures reads model-specific option and advanced option values from the `standard.opt` file, and from the `.ini` files in a certain [reading order \(page 271\)](#), and creates the databases `options_model.db` and `options_drawings.db`, and the `options.ini` file under the model folder.

Changing a model-specific options or advanced options

- When you change a [model-specific \(page 299\)](#) option or advanced option and press **OK** or **Apply** in the **Options** or **Advanced Options** dialog box, the settings are taken into use (otherwise you will get a warning message).
- The updated model-specific option or advanced option settings are saved in `options_model.db` and `options_drawings.db` under model folder when the model is saved.
- In addition, there are also some special model-specific advanced options that can be updated from the `options.ini` file located in the model folder, for example, new advanced options that are not yet in the **Advanced Options** dialog box.
- You can change model-specific advanced options only in the **Advanced Options** dialog box or in the `options.ini` file that is located in model folder.

- You can change model-specific options only in the **Options** dialog box manually or by loading `standard.opt` file values in the dialog box.

Changing a user-specific options or advanced options

- When you change a [user-specific \(page 299\)](#) option or advanced option, and press **OK** or **Apply** in the **Options** or **Advanced Options** dialog box, the settings are saved in `options.bin` in `..\Users\\AppData\Local\Trimble\Tekla Structures\\UserSettings`.
- You can change user-specific advanced options only in the **Advanced Options** dialog box.
- You can change user-specific options only in the **Options** dialog box manually or by loading `standard.opt` file values in the dialog box.

Saving customized settings in the Options dialog box

- You can save your own model-specific settings in the [Options dialog box \(page 280\)](#) by using the **Save** button. Then the `standard.opt` file is saved in the `\attributes` folder under the model folder.

Creating a list of advanced options and their values

- You can create a complete list of advanced options in a text file by clicking **Write to file** in the **Advanced Options** dialog box. The list shows the name of the advanced option, current value and type.

For more information about the `standard.opt` file, see [Standard.opt settings](#)

Settings in the Options dialog box

The **Options** dialog box (**File menu > Settings > Options**) contains the current values for a number of Tekla Structures settings.

Check the settings before you start modeling and change them, if necessary.

The [model-specific \(page 299\)](#) settings in this dialog box are saved in the `options_model.db` and `options_drawings.db` databases in the model folder, and the [user-specific \(page 299\)](#) settings in `options.bin` in your local `<user>` folder. Changing user- or model-specific options in the **Options** dialog box does not require Tekla Structures restart.

You can also save your own settings by using the **Save** button. Then the `standard.opt` file is saved in the `\attributes` folder under model folder. You may want to copy this file to your firm folder. When you create a model, the `standard.opt` is read from the firm folder.

The options in the **Options** dialog box are described below.

Clash check settings

NOTE: Settings on this page are model specific. Changing the settings does not require Tekla Structures restart.

Depending on how the objects selected for clash checking have been modeled, different clash check settings are used. For example, if you have modeled embeds as studs, steel parts, or reinforcing bars, respectively either bolt settings, part settings, or reinforcement settings are relevant.

NOTE Tekla Structures uses a hard-coded tolerance when checking clashes between native parts. If native parts overlap less than 0.25 mm, clashes are not reported.

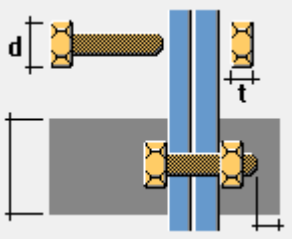
Option	Description
<p>Allowed penetration volume</p> 	<p>Defines the allowed clash check tolerance if small collisions are acceptable and can be ignored.</p> <p>If the clashing volume is smaller than the given value, for example 1 mm³, then the clash is not reported.</p> <p>Enter the value in the current volume units.</p>
<p>Clash check between bolt and bolted part</p>	<p>Defines whether the model is checked for clashes that occur between bolts and the related bolted parts.</p> <p>If you select Yes, Tekla Structures will check the bolts against the real geometry of the bolted part profiles including roundings, and using the real bolt dimensions.</p>
<p>Define the clash check clearance area for bolts</p> 	<p>Use to check if bolts collide with parts and if there is enough space to fix the bolts.</p> <p>Enter the clearance dimensions in relation to the bolt head or nut diameter d (the larger value), and the nut thickness t. The clearance in front of the bolted parts is the same as the bolt length.</p> <p>If you do not enter a value, Tekla Structures uses the default value.</p> <p>If you clear the check boxes, the clearance will be zero.</p> <p>If Tekla Structures cannot find the bolt head or nut diameter in the bolt</p>

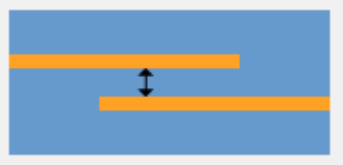
Option	Description
	catalog, it uses the shank diameter instead.
Exact solid weld clash check	<p>Defines whether the model is checked for duplicate and overlapping welds and for clashes that occur between welds and other objects (such as parts and bolts).</p> <p>If you select Yes, Tekla Structures will check the welds against other welds, against bolts, and against the real geometry of the part profiles including roundings, and using the weld solid dimensions with normal accuracy.</p>
Reinforcing bar vs steel part clearance (negative value to allow overlap)	<p>Defines the minimum clearance or the allowed overlap for reinforcing bars when they are checked against steel parts.</p> <p>To allow reinforcing bars to overlap steel parts and to ignore the ribs of bars, enter a negative value. The maximum overlap is the actual bar radius.</p> <p>Tekla Structures only checks the distance from bar side to part. Tekla Structures does not check the distance from bar end to part.</p> <p>If you clear the check box, Tekla Structures will not check the clearance.</p>
Reinforcing bar clearance (negative value to allow overlap) 	<p>Defines the minimum clearance or the allowed overlap for reinforcing bars when they are checked against other reinforcing bars.</p> <p>To allow reinforcing bars to overlap, enter a negative value.</p> <p>If you clear the check box, Tekla Structures will not check the clearance.</p>

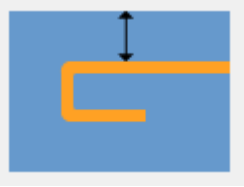
Option	Description
<p data-bbox="311 277 778 309">Reinforcing bar cover thickness</p> 	<p data-bbox="850 277 1310 342">Defines the reinforcing bar cover thickness.</p> <p data-bbox="850 360 1372 703">Tekla Structures checks the cover thickness against the part that the reinforcing bar belongs to. Tekla Structures only checks the distance from bar side to part surface. Tekla Structures does not check the distance from bar end to part surface. If the bar penetrates a part surface, a clash is reported, even if the bar is completely inside a cast unit or pour.</p> <p data-bbox="850 721 1326 824">If you clear the check box, Tekla Structures will not check the cover thickness.</p>

Components settings

Tekla Structures uses the information on the **Components** tab when it creates parts using system components.

Component properties defined in component dialog boxes override these settings. Tekla Structures only uses these settings if the corresponding boxes in the component dialog boxes are empty.

If you change settings here, Tekla Structures only applies the new settings to components you subsequently create. Components you created prior to changing the preferences are not affected.

NOTE: Settings on this page are model specific. Changing the settings does not require Tekla Structures restart.

Option	Description
<p data-bbox="311 1415 517 1447">Profile names</p>	<p data-bbox="850 1415 1356 1588">Defines parametric profile prefixes for plates. It is important that profile names are set up correctly so that you can use filters and wizards effectively.</p> <p data-bbox="850 1606 1372 1881">Profile names must exist in the profile catalog. If you want to use a parametric profile that does not have a name in the catalog, first add it to the Profile Catalog, then enter it here. Tekla Structures uses the Folded plate prefix when you use the folded plates in components.</p>

Option	Description
Bolts	<p>In components, Tekla Structures uses Factor of bolt edge distance and Compare edge distance to to check that the bolts it creates are not too close to the edge of a part, and warns you if they are. Check that Factor of bolt edge distance is set according to the standard you are using. The default edge distance setting depends on your environment.</p> <p>Compare edge distance defines whether the edge distance checks are based on bolt or hole diameter.</p> <p>To define the default bolt properties to use in connections, select a Bolt standard and Bolt size.</p>
Parts	<p>Part material defines the default part material grade.</p> <p>Part start numbers defines start numbers for parts that are Welded to primary and Welded to secondary, Loose parts, and Assembly loose parts.</p> <p>Cross-check these settings against the numbering series you define to make sure they do not overlap. If they overlap, Tekla Structures may create two non-identical parts with the same part number. This generates an error in the Numbering history log file (page 333).</p>

Drawing dimensions settings

NOTE: Settings on this page are model specific. Changing the settings does not require Tekla Structures restart.

For more information about dimension settings, see Define dimensioning.

Option	Description
Exaggeration	<p>This setting defines the default values for Exaggeration limit and Exaggeration scaling.</p> <p>When you enable the exaggeration of the dimensions, a drawing dimension</p>

Option	Description
	<p>that is narrower than the defined limit is expanded. Exaggeration limit defines the default value for this limit.</p> <p>Exaggeration scaling defines whether you are using Paper or Model as the exaggeration scaling method:</p> <ul style="list-style-type: none"> • If you select Paper, the exaggeration limit is multiplied by the view scale. • If you select Model, and the scale is 1:10, all the dimensions smaller than 10 mm are exaggerated regardless of the drawing scale. <p>For more information about exaggerated dimensions, see Create exaggerated dimensions.</p>
Absolute dimensions	<p>Show zero in absolute dimensions --> Yes shows zero at the zero points in absolute dimensions.</p> <p>Draw absolute dimension values parallel to dimension line --> Yes shows dimensions parallel to dimension lines in absolute dimensions.</p> <p>For more information, see Change the appearance of absolute dimensions.</p>
Dimensions in tags	<p>Units, Format and Precision define the default unit, format and precision used in dimension tags.</p> <p>Available units: mm, cm, m, foot - inch, cm / m, inch, feet.</p> <p>Available formats: ###, ###[.#], ###.#, ###[.##], ###.##, ###[.###], ###.###, ### #/# and ##/#.###.</p> <p>Available precision: 0.00, 0.50, 0.33, 0.25, 1/8, 1/16, 1/32, 1/10, 1/100, 1/1000</p>
Show dimension in middle tag of automatic dimension	<p>Defines whether you want to create dual dimension tags in assembly,</p>

Option	Description
	<p>single-part, cast unit, or general arrangement drawings.</p> <p>For more information about automatic dual dimensions, see What are automatic view-level dimensions.</p> <p>For more information about manual dual dimensions, see Add dual dimensions manually.</p> <p>When Tekla Structures creates the drawing, it adds the lower dimension tag in the selected unit, format and precision.</p>
Dimension line	<p>Dimension line extension length for line arrow defines the length of the line extension for dimensions that have line arrows.</p> <p>Note that line extensions are not applied to dimensions that have different arrows from line arrows, and certain knock-off dimension types.</p>

Drawing objects settings

NOTE: Settings on this page are model specific. Changing the settings does not require Tekla Structures restart.

Option	Description
Edge chamfer	<p>Line color defines the default line color of the edge chamfers in drawings.</p> <p>Line type defines the default line type of the edge chamfers in drawings.</p> <p>These values are overridden by the values set in the Edge Chamfer Properties dialog box.</p> <p>For more information about edge chamfers, see Edge chamfers in drawings.</p>

General settings

NOTE: On this page, **Autosave** settings are user specific. All other settings are model specific. Changing the settings does not require Tekla Structures restart.

Option	Description
Autosave	<p>Autosave interval: Autosave after every xx modeling or editing commands defines how often Tekla Structures automatically saves a model and a drawing.</p> <p>This number represents the number of commands you have given. For example, if you create many objects without interrupting (Esc), it counts as one command.</p> <p>Autosave after creating every xx drawings defines the number of drawings after which Tekla Structures automatically saves your work.</p> <p>For more information, see:</p> <ul style="list-style-type: none">Save a modelAutosaving in multi-user mode
Default adaptivity	<p>Off means that adaptivity is not defined.</p> <p>Relative defines that handles retain their relative distances to the nearest part faces in relation to the part's overall size.</p> <p>Fixed defines that handles retain their absolute distances to the nearest part faces.</p> <p>You can also modify the adaptivity settings for each part separately. These modifications override the default settings in the Options dialog box.</p> <p>For more information about adaptivity, see Modify the adaptivity of reinforcement, surface treatment, or edge chamfers in parts.</p>

Load modeling settings

Use the settings on the **Arrow length** tab to scale loads in model views.

Use the settings on the other tabs of this page to define the building code and safety factors Tekla Structures uses in load combination.

NOTES:

- Settings on this page are model specific. Changing the settings does not require Tekla Structures restart.
- You should not need to change the building code or safety factors during the project. If you change these settings, you will also need to change the load group types and check the load combinations.

Numbering settings

NOTE: Settings on this page are model specific. Changing the settings does not require Tekla Structures restart.

Option	Description
Position number separator	Defines the default position number separator. The options are dot (.), comma (,), slash (/), and hyphen (-).
Rebar position number separator	Defines the default reinforcing bar position number separator. The options are dot (.), comma (,), slash (/), and hyphen (-).
Part number type	Defines the default part number type. The options are Part number and Combined assembly / part number .

Orientation mark settings

NOTE: Settings on this page are model specific. Changing the settings does not require Tekla Structures restart.

For details of what affects the part orientation and how, see Indicate part orientation.

Option	Description
North direction	Project north (degrees counter clockwise from global x) defines which direction is north in the model.

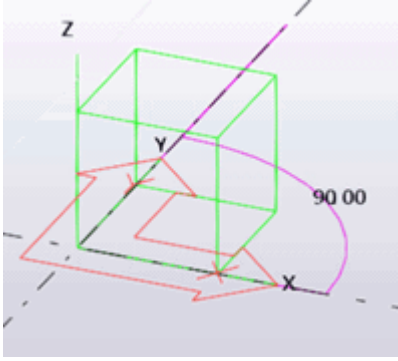
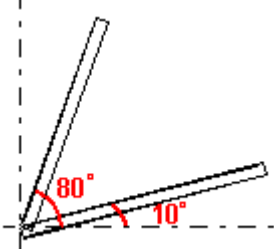
Option	Description
	<p>Enter the value in degrees counter-clockwise from the global x axis.</p> 
Part viewing direction	<p>Defines which direction parts are viewed from in drawings.</p>
<p>Beam skew limit Column skew limit</p>	<p>Tekla Structures uses limit angles to determine whether a part is a beam or a column when creating orientation marks. Tekla Structures treats parts outside these limits as braces.</p>  <p>Parts skewed more than 80° are columns.</p> <p>Parts skewed less than 10° are beams.</p>
Preferred location for mark	<p>Defines the location of part marks in drawings, to the left or right end of the part.</p>
Mark always to center of column	<p>This setting only affects columns.</p> <p>Yes places part marks in the center of columns in plan views. To indicate part orientation, include compass</p>

Option	Description
	<p>direction (Face direction) in the part mark instead.</p> <p>No places part marks on the same flange in general arrangement and assembly drawings.</p>

Rebar set settings

NOTE: Settings on this page are model specific and only apply to rebar sets, not to single reinforcing bars, reinforcing bar groups, or reinforcement meshes. Changing the settings does not require Tekla Structures restart, but you need to update the existing rebar sets in the model. To do this, go to the **Rebar** tab on the ribbon and click **More** --> **Regenerate**.

Option	Description
Covers and locations tab	
Concrete cover	<p>Under Part global coordinate system, define the default concrete cover thickness between the rebar set bars and the following faces of concrete parts:</p> <ul style="list-style-type: none"> • Top • Bottom • Sides <p>To use the parts' local coordinate system, under Part local coordinate system, define the default concrete cover thickness at the following faces of concrete parts:</p> <ul style="list-style-type: none"> • Top • Bottom • Front • Back • Start • End <p>You can also define concrete cover settings for each concrete part separately. These modifications override the default settings in the Options dialog box.</p>

Option	Description
Layer prefix	<p>Under Part global coordinate system and/or Part local coordinate system, define the default bar layer prefixes at different faces of concrete parts.</p> <p>You can also define bar layer settings for individual rebar sets or leg faces, or for individual bars using the user-defined attributes of property modifiers. These modifications override the default settings in the Options dialog box.</p>
Links	<p>Define the bar layer prefix for rebar set bars that have four or more legs, for example closed stirrups.</p>
General tab	
Minimum lengths to be created	<p>Define Minimum bar length to prevent Tekla Structures from creating reinforcing bars that are too short. This setting is primarily for straight bars. Enter the minimum bar length as Distance or as Coefficient of bar diameter.</p> <p>Define Minimum straight start/end leg length for bent reinforcing bars. Enter the minimum leg length as Distance or as Coefficient of bar diameter.</p> <p>These settings are also available in the Rebar set properties and in the Rebar property modifier properties.</p>
Rounding and step tapering tab	
Rounding	<p>Define whether the lengths of straight bars, first and last legs, and intermediate legs are rounded in the model, and whether the bar lengths are rounded up, down, or to the</p>

Option	Description
	<p>nearest suitable number according to the rounding accuracy.</p> <p>At splitter locations, define how much the bar lengths can be rounded up.</p> <p>Rounding settings are also available in the Rebar set properties and in the Rebar property modifier properties.</p>
Step tapering	<p>Define the tapering step values for straight bars, first and last legs, and intermediate legs.</p> <p>Step tapering settings are also available in the Rebar set properties and in the Rebar property modifier properties.</p>

Units and decimals settings

NOTE: Settings on this page are model specific. Changing the settings does not require Tekla Structures restart.

The number located to the right of each option indicates the number of decimals. The number of decimals affects the input and storage accuracy. Always use a sufficient number of decimals.

For more information on unit and decimal settings, see Change units and decimals.

Option	Description
Length	mm, cm, m, in (decimal), ft (decimal), ft-in
Angle	°, rad

Option	Description
Spring constant	kg/m kg/cm kg/mm T/m T/cm T/mm N/m N/cm N/mm daN/m daN/cm daN/mm kN/m kN/cm kN/mm lbf/in lbf/ft kip/in kip/ft
Rot. spring constant	kgm/rad kgm/° Tm/rad Tm/° Nm/rad Nm/° daNm/rad daNm/° kNm/rad kNm/° lbf-in/rad lbf-in/° lbf-ft/rad lbf-ft/° kip-in/rad kip-in/° kip-ft/rad kip-ft/°
Factor	(unitless)
Force	kg T N daN kN lbf kip

Option	Description
Distributed load	kg/m T/m N/m daN/m kN/m lbf/in lbf/ft kip/in kip/ft
Surface load	kg/m ² T/m ² N/m ² daN/m ² kN/m ² psi psf ksi ksf
Moment	kgm Tm Nm daNm kNm lbf-in lbf-ft kip-in kip-ft
Distributed moment	kgm/m Tm/m Nm/m daNm/m kNm/m lbf-ft/ft kip-ft/ft
Temperature	°C, °F, K
Deformation	mm cm m in (decimal) ft (decimal) ft-in

Option	Description
Section dimension	mm cm m in (decimal) ft (decimal) in ft-in
Angle	°, rad
Area	mm ² cm ² m ² in ² ft ²
Section modulus	mm ³ cm ³ m ³ in ³ ft ³
Moment of inertia	mm ⁴ , cm ⁴ , in ⁴
Radius of inertia	mm cm m in (decimal) ft (decimal) ft-in
Torsion constant	mm ⁴ , cm ⁴ , in ⁴
Warping constant	mm ⁶ , cm ⁶ , in ⁶
Cover area	m ² /m mm ² /m cm ² /m ft ² /ft in ² /ft in ² /in

Option	Description
Strength	kg/m ² kg/cm ² kg/mm ² T/m ² T/cm ² T/mm ² N/m ² N/cm ² N/mm ² daN/m ² daN/cm ² daN/mm ² kN/m ² kN/cm ² kN/mm ² psi psf ksi ksf
Modulus	kg/m ² kg/cm ² kg/mm ² T/m ² T/cm ² T/mm ² N/m ² N/cm ² N/mm ² daN/m ² daN/cm ² daN/mm ² kN/m ² kN/cm ² kN/mm ² psi psf ksi ksf
Density	kg/m ³ T/m ³ N/m ³ kN/m ³ lbf/ft ³

Option	Description
Weight	kg T N lbf kip
Strain	o/oo, %, (unitless)
Thermal dilat. coeff.	1/°C, 1/°F, 1/K
Ratio	o/oo, %, (unitless)
Volume	mm ³ cm ³ m ³ in ³ ft ³
Length	mm, cm, m, in (decimal), ft (decimal), ft-in
Angle	°, rad
Reinforcement area	mm ² cm ² m ² in ² ft ²
Transverse reforc.	m ² /m mm ² /m cm ² /m ft ² /ft in ² /ft in ² /in
Weight	kg T N lbf kip
Mass/Length	kg/m T/m N/m daN/m kN/m lbf/ft

Option	Description
Volume	mm ³ cm ³ m ³ in ³ ft ³
Force	kg T N daN kN lbf kip
Distributed load	kg/m T/m N/m daN/m kN/m lbf/in lbf/ft kip/in kip/ft
Surface load	kg/m ² T/m ² N/m ² daN/m ² kN/m ² psi psf ksi ksf
Moment	kgm Tm Nm daNm kNm lbf-in lbf-ft kip-in kip-ft
Temperature	°C, °F, K

Option	Description
Stress	kg/m ² kg/cm ² kg/mm ² T/m ² T/cm ² T/mm ² N/m ² N/cm ² N/mm ² daN/m ² daN/cm ² daN/mm ² kN/m ² kN/cm ² kN/mm ² psi psf ksi ksf
Deformation	mm cm m in (decimal) ft (decimal) ft-in

See also

[File storing options and advanced options \(page 279\)](#)

Settings defined by advanced options

Advanced options can be user-, model-, system or role-specific:

- User-specific advanced options** are saved in your local `options.bin` file, which is by default located in `C:\Users\\AppData\Local\Trimble\Tekla Structures\\UserSettings`, and work in the specified way in all models that you have. The folder can be changed using the advanced option `XS_USER_SETTINGS_DIRECTORY`. In the **Advanced Options** dialog box, the type is **USER**. Some user-specific advanced options require restarting of Tekla Structures after changing the value.
- Model-specific advanced options** work in the specified way only in the current model. They are saved to `options_model.db` and `options_drawings.db` under model folder. In the **Advanced Options** dialog box, the type is **MODEL** or **DRAWING**. Some special model-specific

options that are not visible in the **Advanced Options** dialog box can be changed from `options.ini` file under the model folder.

- **System-specific advanced options** are general to all sessions of Tekla Structures, and work in the specified way for all users and in all models. In the **Advanced Options** dialog box, the type is **SYSTEM**. A system-specific advanced option can be stored to options database by clicking **SYSTEM** next to the option and changing it to **MODEL(SYSTEM)**. Note that the changed value only works for the current model. A **MODEL(SYSTEM)** advanced option can be changed back to **SYSTEM** by changing it to **SYSTEM**, and in this case it will be removed from the options database. Some system-specific advanced options require restarting of Tekla Structures after changing the value.

The system-specific advanced options are read from environment `.ini` files:

- **Global system settings** are read from common [env_global_default.ini \(page 276\)](#) in `..\ProgramData\Trimble\Tekla Structures \<version>\environments\common\`. These settings are used in all environments.
- **Environment-specific system settings** are read from [env_<environment>.ini \(page 276\)](#) in your environment folder. They override any settings that are defined on a global level in `env_global_default.ini`.
- **Role-specific system settings** are read from [role_<role>.ini \(page 277\)](#) in environment folder. They override any settings that are defined on a global and environment level in `env_global_default.ini` and `env_<environment>.ini`.
- **Company level system-specific system settings** override all other system-specific advanced options. You can save them in the firm or project folders by setting the folders for the advanced options and .
- **SYSTEM(ROLE)** options are typically role specific. The settings are read from `.ini` files and are not saved to the databases. When changed or if the type is changed, the option will become model specific and be saved to the databases. **MODEL/DRAWING(ROLE)** options are **SYSTEM(ROLE)** options whose type and/or setting has been changed. The change would be used when you want the **SYSTEM(ROLE)** option to be saved with the model to `options_model.db` and `options_drawings.db` under model folder. These settings can be set back to **SYSTEM(ROLE)**, which will then take into use the default value.

See also

[Typical initialization files \(.ini files\) and their reading order \(page 271\)](#)

Change the advanced option values in the Advanced Options dialog box

Use advanced options to configure Tekla Structures to suit the way you work, or to comply with specific project requirements or industry standards. Change the advanced options only in the **Advanced Options** dialog box. The settings in the **Advanced Options** dialog override the settings in any other initialization file.

1. On the **File** menu, click **Settings --> Advanced options** to open the **Advanced Options** dialog box, or press **Ctrl+E**.

2. Browse the categories to find the advanced option you want to set.

You can also enter a search term in the **Search** box. To search the search term in all categories, select **In all categories**. You can also use wildcards. For example, to find all advanced options that have the words `anchor` and `filter` and that have any characters between these two words, enter `anchor*filter`.

3. Set the advanced option to the desired value by entering the value or by selecting the value from the list.

- You can change the type of the role-specific advanced options from **SYSTEM (ROLE)** to **MODEL (ROLE)** or **DRAWING(ROLE)** and vice versa from the list next to the option type. When you change the option type to **SYSTEM(ROLE)**, the value automatically changes to the default value. When you enter a value for a **SYSTEM (ROLE)** option, it changes to **MODEL (ROLE)** or **DRAWING(ROLE)**.
- You can change the type of system-specific advanced options from **SYSTEM** to **MODEL(SYSTEM)**, in which case the value is saved in the options database. If you reset the advanced option back to **SYSTEM**, the value will be removed from the options database and the value specified in initialization files will be used.
- You can use switches with some advanced options, for example, to define the contents of marks: `%TPL: PROJECT . NUMBER%`.
- If you are defining a switch for an advanced option in the **Advanced Options** dialog box, use single percent signs `%xxx%` around the switch. If you are defining the switch in an `.ini` file, use double percent signs `%xxx%%` around the switch.
- If you need to enter a folder path, you can type a backslash at the end of the folder path or leave it out.

4. Click **Apply** or **OK**.

TIP To create a complete list of advanced options in a text file, click **Write to file**. The list shows the name of the advanced option together with its current value and type. Note that writing to a file is

only an export of the current settings, it is not another way of changing the advanced options.

See also

[Settings defined by advanced options \(page 299\)](#)

6.4 Input files (.inp files)

Tekla Structures uses input files for various purposes, for example, to manage user-defined attributes and some component dialog boxes, and for defining how components work. All input files have the extension `.inp`.

Input files that you can use for configuring Tekla Structures are listed below.

File	Description
<code>analysis_design_config.inp</code>	Contains settings for analysis and design.
<code>fltprops.inp</code>	Includes materials and dimensions of available flat bars (page 312) .
<code>mesh_database.inp</code>	Contains definitions for reinforcement meshes.
<code>objects.inp</code>	Used to manage user-defined attributes (page 306) .
<code>objects_rebar_set.inp</code>	Used to manage user-defined attributes of rebar sets.
<code>pop_mark_parts.inp</code>	Contains settings for pop-marking.
<code>privileges.inp</code>	Used to control access rights.
<code>profitab.inp</code>	Contains available parametric profiles (page 163) .
<code>rebar_config.inp</code>	Contains settings for reinforcement marks.
<code>rebar_database.inp</code>	Rebar catalog (page 246) . Contains definitions for reinforcing bars and strands.
<code>rebar_schedule_config.inp</code>	Contains internal bending types of reinforcing bars and their mapping to area specific bending codes. Rebar shape manager is a more versatile way to define reinforcing bar bending shapes.

Tekla Structures also imports and exports rebar catalogs as `.inp` files.

See also

[Environment database file \(page 308\)](#)

Properties of the objects.inp file

Here, we explain the structure of user-defined attribute definitions. For general information on modifying the definitions, such as file locations and reading order, see [Define and update user-defined attributes \(UDAs\) \(page 306\)](#).

This example shows the main properties of `objects.inp`:

```
attribute("MY_INFO_1", "My Info 1", string, "%s", no, none, "0.0", "0.0")
{
  value ("", 0)
}
picture("image_name", 8, 2, 260, 25)
```

Property	In the example	Description
attribute, unique_attribute, or	attribute	attribute is a regular attribute, which is copied with other part properties. unique_attribute is a non-copyable attribute. The value of the attribute is never copied to another part. For example part checking status attributes usually cannot be copied.
attribute_name	MY_INFO_1	Attribute name, used to find the attribute value. Ensure that Tekla Structures does not already use the attribute name you use. Consider using a prefix that ensures the name is unique, for example, your initials, or an abbreviation of your company name. The attribute name is case-sensitive. Do not use spaces or reserved characters in attribute names. The maximum

Property	In the example	Description
		<p>length of the name can be 19 characters.</p> <p>To include the attribute in a report or template, add the name of the attribute to your layout in the Template Editor. When you run a report or create a drawing, Tekla Structures displays the current value of the attribute.</p>
label_text	My Info 1	<p>Label that Tekla Structures displays in the dialog box.</p> <p>Some default attributes have prompts like <code>j_comment</code>, meaning that the prompt comes from the <code>joints.a11</code> message file.</p>
value_type	string	<p>integer or float for numbers</p> <p>string for text</p> <p><code>string_not_modifiable</code> for text whose modification is prevented. A field with the <code>string_not_modifiable</code> property is always displayed as dimmed and it cannot be switched on or off. The value in the field is not saved when clicking the Apply button or modified when clicking the Modify button.</p> <p><code>option</code> for lists</p> <p><code>date</code> for date with small calendar</p>

Property	In the example	Description
		<p>date_time_min for date and time [12:00] with small calendar</p> <p>date_time_sec for date and time [12:00:00] with small calendar</p> <p>If you change the value type of a field that already contains values in the model, make sure that the values are valid for the new data type and verify the results.</p>
field_format	%s	<p>Definition of the field format in the dialog box</p> <ul style="list-style-type: none"> • %s for strings • %d for numbers
special_flag	no	<p>no or yes</p> <p>For parts: consider in numbering</p> <p>For drawings: display the attribute value in Document manager</p> <p>For other elements: no effect</p>
check_switch	none	<p>none</p> <p>This option is not used.</p>
attribute_value_max	0.0	<p>0.0</p> <p>This option is not used.</p>
attribute_value_min	0.0	<p>0.0</p> <p>This option is not used.</p>

Property	In the example	Description
picture	picture	picture is used for adding images in user-defined attributes dialog boxes.
image name	image_name	The name of the image
width	2	The width reserved for the image

Property	In the example	Description
height	8	The height reserved for the image
horizontal offset	260	The horizontal distance of the left edge of the image from the left edge of the dialog box
vertical offset	25	The vertical distance of the top edge of the image from the top edge of the dialog box counted from the lower edge of the tab section

Define and update user-defined attributes (UDAs)

The property pane and many dialog boxes contain user-defined attributes (UDAs) for various objects, including beams, columns, bolts and drawings. Tekla Structures displays these fields when you click the **More** button in the property pane or the **User-defined attributes** button in a dialog box. For example, comment, locked, and erection status are user-defined attributes.

When you define new user-defined attributes

The user-defined attributes are managed in the [objects.inp \(page 303\)](#) file. To define new user-defined attributes, create your own `objects.inp` file in the model, project or firm folder. After adding your own user-defined attributes, you need to run the **Diagnose and change attribute definitions** command to [update the definitions \(page 307\)](#) in the model.

When you [define new user-defined attribute \(page 308\)](#), make the definition of the user-defined attribute unique. This is because a user-defined attribute cannot have different definitions for different object types, such as beams and columns.

The `object.inp` files are merged so that if there are user-defined attributes in any of the files, they are displayed in the user interface. Tekla Structures merges the files in a way that eliminates duplicate attributes. If Tekla Structures encounters the same attribute name in different `objects.inp` files, the attribute from the first read `objects.inp` file will be used.

If you need to have several `objects.inp` files in the same folder, you can use a suffix in the file name to use all the files. This enables having several `objects_<suffix>.inp` files in the same folder. The file name could be `objects_precast.inp`, for example.

WARNING Do not copy the `objects.inp` file in the `..\environments\common\inp\` folder. Copying the file creates unnecessary duplicates and later `objects.inp` updates by Tekla Structures can be lost.

Tekla Structures reads the `objects.inp` files from the following folders in the following order:

1. model folder
2. project folder
3. firm folder
4. system folder
5. `inp` folder

Changing existing user-defined attribute definitions

Updating a user-defined attribute definition in a model does not convert any values that are already stored in the field. If you change the value type of a field that already contains values in the model, make sure that the values are valid for the new data type and verify the results.

The safest approach is to create a new attribute when the format of the values in the field changes. If you want to convert user-defined attribute values, you can create a report that lists the values, convert them using external tools and import the converted values.

See also

[Environment database file \(page 308\)](#)

Update definitions of user-defined attributes (UDAs) in a model

When you have changed definitions of a user-defined attribute by modifying the `objects.inp` file, you need to update the definitions in the model.

1. Open the model.
2. On the **File** menu, click **Diagnose & repair** and in the **Utilities** area, click **Diagnose and change attribute definitions**.

The **Diagnose & Change Attribute Definitions** dialog box opens.

3. Select an attribute from the list on left side to see the comparison of current definitions and `objects.inp` definitions.
4. Select the definitions you want to update in the **Object classes with Objects.inp differences compared to current settings** list.
5. Click **Change current settings to selected Objects.inp settings**.

See also

[Define and update user-defined attributes \(UDAs\) \(page 306\)](#)

[Environment database file \(page 308\)](#)

[Properties of the objects.inp file \(page 303\)](#)

[Example: Create and update a user-defined attribute \(UDA\) \(page 308\)](#)

Environment database file

To guarantee consistent model behavior when a model is used with different roles, the environment database file (`environment.db`) contains the definitions of the user-defined attributes (UDAs) used in the model.

When you create a new model, Tekla Structures merges the definitions from your [objects.inp \(page 303\)](#) files to the `environment.db` file. Later, when you add **new** user-defined attributes in the `objects.inp` file, the definitions are saved in `environment.db` as you open the model.

You can modify your [user-defined attributes \(page 306\)](#) in an `objects.inp` file but the **changed** definitions do not come into effect automatically. If there are conflicts, the definitions in `environment.db` win. You need to run the **Diagnose and change attribute definitions** command to see the conflicts between `environment.db` and `objects.inp`, and select the attribute definitions that you want to update.

See also

[Update definitions of user-defined attributes \(UDAs\) in a model \(page 307\)](#)

[Example: Create and update a user-defined attribute \(UDA\) \(page 308\)](#)

Example: Create and update a user-defined attribute (UDA)

This example shows how to create your own user-defined attribute (UDA) and update the model to use the changed attribute definition.

Create a user-defined attribute

1. Create a new model and save it.

The user-defined attributes in the model are merged from [objects.inp \(page 306\)](#) files and Tekla Structures saves the attribute definitions in the [environment.db \(page 308\)](#) file in the model folder.

2. Close the model.
3. Create an input file called `objects.inp` in the model folder by using a standard text editor.

4. Enter the following information in `objects.inp`. For details about the properties in the attribute string, see [objects.inp \(page 306\)](#).

```
/
*****
*/
/* Part attributes */
/
*****
*/
part(0,"Part")
{
  /* User defined tab page */
  tab_page("My UDA tab")
  {
    /* User defined attribute */
    attribute("MY UDA", "My UDA", string,"%s", no, none, "0,0", "0,0")
    {
      value("", 0)
    }
  }
  tab_page("My UDA tab", "My UDA tab", 19)
  modify (1)
}
/
*****
*/
/* Column attributes */
/
*****
*/
column(0,"j_column")
{
  /* Reference to the user defined tab page that is defined above in */
  /* the part() section: */
  tab_page("My UDA tab", "My UDA tab", 19)
  modify (1)
}
```

NOTE If you want to create a user-defined attribute that also affects numbering, set the [special_flag \(page 303\)](#) property of the attribute to `yes` (it is `no` in the example above). Also, just like in the example above, the definition of the `tab_page` must be in the `part` section, and the `column` (beam, etc.) section must have only a reference to it.

5. Save `objects.inp`.

Test the user-defined attribute

1. Open the model.
2. Create a steel column.
3. Double-click the steel column to open its properties in the property pane.
4. Click the **More** button.

5. Go to **My UDA tab**.

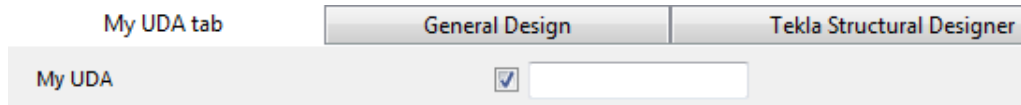

6. Enter a value in the **My UDA** box.
7. Click **Modify**.
8. Copy the steel column.
9. Check the **My UDA** box of the new steel column.
The attribute value was also copied.
10. Close the model.

Modify the user-defined attribute to make it unique

1. Open the `objects.inp` file in the model folder by using a standard text editor.
2. Enter `unique_` before the user-defined attribute.

```

/
*****
*/
/* User-defined attributes */
/
*****
*/
part(0,"Part")
{
  /* Common tab pages for part attributes */
  tab_page("My UDA tab")
  {
    unique_attribute("MY UDA", "My UDA", string,"%s", no, none, "0,0", "0,0")
    {
      value("", 0)
    }
  }
  tab_page("My UDA tab", "My UDA tab", 19)
  modify (1)
}
/
*****
*/
/* Column attributes */
/
*****
*/
column(0,"j_column")
{
  tab_page("My UDA tab", "My UDA tab", 19)
  modify (1)
}

```

This makes the user-defined attribute unique, meaning that the value of the user-defined attribute will not be copied to another part.

3. Save `objects.inp`.

Test the unique user-defined attribute

1. Open the model.
2. Enter a value in the **My UDA** box for a steel column and click **Modify**.
3. Copy the steel column.
4. Check the **My UDA** box of the new column.
5. The value was copied, so the user-defined attribute in the model is not unique. There is a conflict between the `environment.db` and `objects.inp` definitions.

Update the definitions of user-defined attributes

1. On the **File** menu, click **Diagnose & repair** and in the **Utilities** area, click **Diagnose and change attribute definitions**.

The **Diagnose & Change Attribute Definitions** dialog box opens.

2. Select **My UDA** in the **Attribute** area on the left.

You can see that **My UDA** is not unique in the current setting, but it is set to unique in `objects.inp`.

Object classes with Objects.inp differences compared to current settings		
Current settings	Object class names	Objects.inp settings
unique=no	part column	unique=yes

3. Select the definition in the area on the right.
4. Click **Change current settings to selected Objects.inp settings**.

Now the definition of the user-defined attribute is updated in the model.

If you now copy a steel column that has a value for **My UDA**, the value is not copied to the new column.

See also

[Update definitions of user-defined attributes \(UDAs\) in a model \(page 307\)](#)

[Define and update user-defined attributes \(UDAs\) \(page 306\)](#)

[Properties of the objects.inp file \(page 303\)](#)

Show plates as flat bars in drawings and reports

Tekla Structures can show plates as the equivalent flat bars for manufacturing. Tekla Structures displays the plates as flat bars in reports and drawings.

1. Set the advanced option `XS_USE_FLAT_DESIGNATION` to `TRUE`.

2. Indicate the prefix you want to use for flat bars using the advanced option XS_FLAT_PREFIX.

For example, XS_FLAT_PREFIX=FLAT.

3. Set other platework-related advanced options as required.
4. Define materials, thickness, and width of available flat bars in the [Fltprops.inp \(page 312\)](#) file.

-
- TIP** • To prevent Tekla Structures from displaying the profile in metric units in the US environment Imperial role, add the flat bar prefix to the [profitab.inp \(page 179\)](#) file as a parametric profile.
- See also page **Platework** in the **Advanced Options** dialog box for information about advanced options related to platework.
-

Define flat bar sizes with the Fltprops.inp file

Use the `Fltprops.inp` file to define the flat bar sizes and material grades that are shown for plates in drawings and reports.

The `Fltprops.inp` file is located in the `\profil` folder in one of the folders under the environment folder `..\ProgramData\Trimble\Tekla Structures\<version>\Environments\`. The exact location may vary depending on your environment. In the default environment, `Fltprops.inp` is located in `..\ProgramData\Trimble\TeklaStructures\<version>\Environments\default\General\Shared`.

NOTE Copy the `Fltprops.inp` file to a model, project or firm folder and then modify the file in the new location as required.

The first row in the file contains flat bar material definitions (enclosed in quotes " ", and without spaces) followed by plate thicknesses. If you do not define a material, you can use all materials for all flat bars. The following rows define the widths of available flat bars.

The units are millimeters.

Example

`Fltprops.inp` contains the following data:

```
5, 6, "S235", 8, 10, "S275J0", 10, 15
40, 45
50, 55
60, 65
70, 75
100, 110
200, 220
```

With the above data, Tekla Structures displays the following plates as flat bars in drawings and reports:

Plate	Material
5x40, 5x45, 6x50, 6x55	All materials
8x60, 8x65, 10x70, 10x75	S235
10x100, 10x110, 15x200, 15x220	S275J0

The flat bars get the prefix that is set in the XS_FLAT_PREFIX advanced option.

See also

[Show plates as flat bars in drawings and reports \(page 311\)](#)

Define unfolding parameters in the `unfold_corner_ratios.inp` file

The unfolding parameters define the location of the neutral axis when a profile is unfolded. The neutral axis is a line which runs along the length of a profile where stress and strain are equal to zero. Tekla Structures uses these parameters to create NC files and to display unfolded profiles in single-part drawings.

To define unfolding parameters, modify the `unfold_corner_ratios.inp` file, located in `..\ProgramData\Trimble\Tekla Structures\<version>\environments\common\system`, using a standard text editor. You can copy the `unfold_corner_ratios.inp` file to a model, project or firm folder and then modify the file in the new location as required. Tekla Structures searches for this file in the default search order.

After modifying the `unfold_corner_ratios.inp` file, restart Tekla Structures for the changes to take effect.

NOTE The settings in the `unfold_corner_ratios.inp` file have no effect in the following cases:

- If the advanced option `XS_USE_OLD_POLYBEAM_LENGTH_CALCULATION` is set to TRUE.
- If the advanced option `XS_CALCULATE_POLYBEAM_LENGTH_ALONG_REFERENCE_LINE` is set to TRUE. This only applies to polybeams with straight sections.

Unfold parameter properties

See below for an example of unfolding parameters in the `unfold_corner_ratios.inp` file and the descriptions of the parameters.

```
1 HE300A S235JR 0 180 2 0 1000 .7
```

Property	In the example	Description
Type	1	1 is polybeams 2 is plates modeled as polybeams (for example, PLT) 3 is for parts which are not unfolded and follow the old polybeam calculation (for example, the line 3 L* * disables unfolding of L profiles)
Profile	HE300A	You can also use wildcards with profile, for example, HE300*.
Material	S235JR	You can also use wildcards with material, for example, S235*.
Rotation / thickness min	0	For polybeams: the minimum angle when the profile is rotated around its longitudinal axis For plates: the minimum thickness of plate
Rotation / thickness max	180	For polybeams: the maximum angle when the profile is rotated around its longitudinal axis For plates: the maximum thickness of plate
Flag	2	This property defines what kind of parts are affected by the next two properties. 1 is sharp folds. Only polybeams with straight chamfers are affected. 2 is curved bends. Only polybeams with curved chamfers are affected.

Property	In the example	Description
Angle / radius min	0	For sharp folds: the minimum angle For curved bends: the minimum radius
Angle / radius max	1000	For sharp folds: the maximum angle For curved bends: the maximum radius Maximum radius is measured to the plane defined by the ratio, so it is not dependent on how the part is created (where the reference axis is located).
Ratio	.7	Defines how much the profile stretches or shrinks when unfolded. Ratio = (1 - the relative location of the neutral axis). If only the inner surface of the profile shrinks, the ratio is 1. If only the outer surface of the profile stretches, the ratio is 0. By default, the ratio is 0.5 for length calculation and 0.0 for bending radius calculation. Tekla Structures applies the unfolding ratio if the profile properties are within the range indicated by the minimum and maximum values.

See also

[Folder search order \(page 361\)](#)

6.5 Data files (.dat files)

Data files contain information used by certain components, or **Rebar shape manager**, for example.

WARNING These files affect the operation of components or **Rebar shape manager**. Do not modify the files listed here unless you are an administrator.

File	Description
joints.dat	Contains data used in Handrailing (1024) and Stanchions (S76) components. Used in the Stanchion connection type option.
railings.dat	Contains data used in Handrailing (1024) . Used in the Stanchion connection type option.
steps.dat	Contains the data for Stairs (S82) and Stairs (S71) . Used in the Step profile and Catalogue step options.
std_flange_plates.dat	Contains data for Tapered column (S99) . Used in the options: <ul style="list-style-type: none">• Outer flange profile• Inner flange profile• Top plate profile
std_stiffener_plates.dat	Contains data used in Tapered column (S99) . Used in the Horizontal stiffener profile box.
marketsize.dat	Contains available market sizes for certain material grade. Can be used with <code>fMarketSize()</code> function in the custom component editor.
import_macro_data_types.dat	Contains the user-defined attributes that you can include in an input file in attribute import.
RebarShapeManager.CustomProperties.dat	Contains the custom properties, template attributes, and user-defined attributes that you can use in bending shape rules in Rebar shape manager .

Note that default data files are read from the environment's system folder, but user-defined data files are stored in the model's `\attributes` folder.

See also

[Define flat bar sizes with the Fltprops.inp file \(page 312\)](#)

6.6 Message files

Tekla Structures uses the information in the message files to display messages in the user interface. Message files include, for example, texts used in dialog boxes.

- Message files with the `.ail` extension are located in the folder `..\Tekla Structures\<version>\bin\messages`.
- Message files with the `.xml` extension are located in the folder `..\Tekla Structures\<version>\bin\messages\DotAppsStrings`.

The files include texts in languages in which the Tekla Structures user interface is available.

See also

[Customize message files \(page 317\)](#)

Customize message files

You can customize the messages that Tekla Structures displays in the user interface.

1. Do one of the following:
 - To modify an `.ail` message file, go to the `..\Tekla Structures\<version>\bin\messages` folder.
 - To modify an `.xml` message file, go to the `..\Tekla Structures\<version>\bin\messages\DotAppsStrings` folder.
2. Open the message file you want to customize using a standard text editor.
3. Modify the message as required.
4. Save the message file.

Example: customize a message file

In this example, you will modify a message that Tekla Structures uses for near side plates in drawings. You want Tekla Structures to display (NS) instead of (N/S).

1. Go to the `..\Tekla Structures\<version>\messages` folder.
2. Open `by_number.ail` using a standard text editor.

The `by_number.ail` file contains both prompts and default texts that Tekla Structures uses in drawings.
3. Browse to the following section:

```

string by_number_msg_no_675
{
...
entry = ("enu", "(N/S)");
};

```

4. Change (N/S) to (NS) in the entry row.
5. Save and close the file.

See also

[Message files \(page 317\)](#)



6.7 Property files

Property files are files that contain the object properties and settings that are displayed in the property pane or in the dialog boxes of different model objects or drawing objects.

By default, Tekla Structures uses the [standard \(page 319\)](#) property files when you apply commands. The default standard property files are read from the environment's system folder.

In addition to the default property files, you can define user-defined property files, and load these saved properties later when you create, for example, new model objects or drawing objects. Tekla Structures stores the saved, user-defined property files in the current model's `\attributes` folder.

To save a user-defined property file, do the following:

In the property pane	In a dialog box
1. Enter a name for the property file in the box next to the  button.	1. Enter a name for the property file in the box next to the Save as button.
2. Click  to save the property file.	2. Click Save or Save as to save the property file.

Example

Change the [standard \(page 319\)](#) steel column properties so that you create a new type of column that you call `custom1`.

1. Open the steel column properties in the property pane.
2. Enter or modify the properties you want to save.
3. In the box next to the  button, enter a name for the new column properties, for example, `custom1`.

4. Click .

Tekla Structures saves the new `custom1.clm` property file in the current model's `\attributes` folder.

See also

[Model folder files and file name extensions \(page 336\)](#)

6.8 Standard files

Standard files are *property files* that Tekla Structures uses by default when you apply commands.

The standard properties are displayed in the property pane of different model objects, such as beams, columns or plates, or in the dialog boxes of, for example, drawing objects.

How to take standard files into use

- In the property pane: the properties are loaded when you select the **standard** option in the upper part of the property pane. The properties are in use immediately.

If the values that you loaded are different from the previous values, the property pane highlights the modified properties.



- In dialog boxes: the properties are loaded when you select the **standard** option in the list next to the **Load** button, and click the **Load** button.



Standard files are named `standard.*` where the symbol `*` is the file name extension. For example, `standard.clm` file is used for steel column properties. The user-defined attributes are saved with the `standard` files as `*.morefiles`. For example, `standard.clm.more` file is used for steel column user-defined attributes.

Tekla Structures reads the default `standard` files from the environment's system folder.

Save a set of standard files

If needed, you can save a set of `standard` files in the current model's `\attributes` folder.

You can then copy the `standard` files to the project folder or the firm folder for future use, to set up Tekla Structures to suit the way you work.

1. To save a set of standard files, go to **Quick Launch**.
2. Start typing `save defaults`.
3. Select the **Save defaults** command from the list.

Tekla Structures saves the following list of `standard` and `*.more` files in the `..\TeklaStructuresModels\<model_name>\attributes` folder:

File	Property
<code>standard.bpl</code> <code>standard.bpl.more</code>	Bent plate properties
<code>standard.clm</code> <code>standard.clm.more</code>	Steel column properties
<code>standard.cpl</code> <code>standard.cpl.more</code>	Contour plate properties
<code>standard.crs</code> <code>standard.crs.more</code>	Orthogonal beam properties
<code>standard.dia</code> <code>standard.dia.more</code>	Twin profile properties
<code>standard.fms</code> <code>standard.fms.more</code>	Plotting frames
<code>standard.fpl</code> <code>standard.fpl.more</code>	Folded plate properties
<code>standard.ipc</code> <code>standard.ipc.more</code>	Concrete item properties
<code>standard.ips</code> <code>standard.ips.more</code>	Item properties
<code>standard.ler</code> <code>standard.ler.more</code>	Layer properties
<code>standard.mvi</code> <code>standard.mvi.more</code>	Model view properties
<code>standard.num</code> <code>standard.num.more</code>	Numbering setup
<code>standard.prf</code> <code>standard.prf.more</code>	Project properties
<code>standard.prt</code> <code>standard.prt.more</code>	Steel beam properties

File	Property
standard.scr standard.scr.more	Bolt properties
standard.wld standard.wld.more	Weld properties

- If you want to load the default property settings from the `standard` files that are saved in the `attributes` folder, go to **Quick Launch** and use the **Load defaults** command.

Create user-defined standard files

You can also create your own `standard` files. Tekla Structures saves the user-defined standard files in current model's `\attributes` folder.

- To save a user-defined `standard` file, open the property pane or a dialog box whose properties you want to save as a `standard` file.
- Modify or enter the properties.
- Save the properties.

- In the property pane: enter `standard` as the name



- In a dialog box: in the box next to the **Save as** button, enter `standard`



as the name , and click **Save as**.

Tekla Structures saves the `standard` file and the related `*.more` file in the current model's `\attributes` folder. If a `standard` file with the same file name extension exists in the `\attributes` folder, Tekla Structures overwrites the previous file.

- When you want to load the `standard` file, select it from the list of the property files in the property pane or in a dialog box.

Alternatively, to load the default property settings from the `standard` files that are saved in the `attributes` folder, go to **Quick Launch** and use the **Load defaults** command.

See also

[Property files \(page 318\)](#)

[Settings in the Options dialog box \(page 280\)](#)

6.9 Catalog files

Tekla Structures uses ASCII and binary files to manage profile, material, reinforcement, bolt and bolt assembly catalogs.

Each environment has its own folder, where the files related to different catalogs are stored. For example, `..\environments\uk\general\profil\` contains the files for managing catalog files used in the United Kingdom. The exact file location may vary depending on the folder structure of your environment files.

The following table lists files and file types related to catalogs.

File type	File name	Used for	Located in
.inp	profitab.inp	Defines the names that you can use for parametric profiles.	In the \profil folder, under the environment folders, in <code>..\ProgramData\Trimble\Tekla Structures\<version>\environments\<environment>\</code>
	rebar_database.inp	The rebar catalog.	In the \profil folder, under the environment folders, in <code>..\ProgramData\Trimble\Tekla Structures\<version>\environments\<environment>\</code>
	mesh_database.inp	The reinforcement mesh catalog.	In the \profil folder, under the environment folders, in <code>..\ProgramData\Trimble\Tekla Structures\<version>\environments\<environment>\</code>
	You can define the file name while exporting.	Created when you export rebar catalogs.	You can define the folder where to export the files.
.cnv	matexp_<software>.cnv	Contains information to convert material names when	In the \profil folder, under the environment folders, in <code>..\ProgramData</code>

File type	File name	Used for	Located in
		transferring model information using links. For example, converts S235JR to FE360B for DSTV.	\Trimble\Tekla Structures \<version> \environments \<environment>\
	prfexp_<software>.cnv	Contains information to convert profile names when transferring model information using links. For example, converts HEA100 to HE100A for DSTV.	In the \profil folder, under the environment folders, in ..\ProgramData \Trimble\Tekla Structures \<version> \environments \<environment>\
.clb	For example, RU_CF.clb	Contains the definitions of parametric profiles used in profitab.inp.	..\ProgramData \Trimble\Tekla Structures \<version> \environments \common\inp
.lis	You can define the file name while exporting.	Created when you export bolt, profile and material catalogs.	You can define the folder where to export the files.
.db	assdb.db	The bolt assembly catalog.	In the \profil folder, under the environment folders, in ..\ProgramData \Trimble\Tekla Structures \<version> \environments \<environment>\
	screwdb.db	The bolt catalog.	In the \profil folder, under the environment folders, in ..\ProgramData \Trimble\Tekla Structures \<version> \environments \<environment>\
.bin	profdb.bin	The profile catalog.	In the \profil folder, under the environment folders,

File type	File name	Used for	Located in
			in ..\ProgramData \Trimble\Tekla Structures \<version> \environments \<environment>\
	matdb.bin	The material catalog.	In the \profil folder, under the environment folders, in ..\ProgramData \Trimble\Tekla Structures \<version> \environments \<environment>\

See also

[Customize the profile catalog \(page 147\)](#)

[Customize the material catalog \(page 139\)](#)

[Customize the bolt catalog \(page 229\)](#)

[Customize the rebar catalog \(page 246\)](#)

6.10 Font files and font conversion files

You can define the location of font files with the advanced option `DXK_FONTPATH` in the `teklastructures.ini` or your environment initialization file. For example, you can use fonts available in the folder `..\ProgramData\Trimble\Tekla Structures\<version>\environments\common\fonts`.

This folder includes the following fonts:

Font	Font type
<code>fixfont.fon</code>	Tekla Structures system font
<code>romco.fon</code>	Tekla Structures system font
<code>romsim.fon</code>	Tekla Structures system font
<code>romsim8.fon</code>	Tekla Structures system font

Fonts are converted using font conversion files available in the same folder:

File	Description
template_fonts.cnv	Used for converting Tekla Structures system fonts (Template Editor fonts) to Windows fonts in DWG/DXF export.
dxfg_fonts.cnv	Used for converting True Type fonts to SHX fonts (font format understood by AutoCAD) in DWG/DXF export.

NOTE The Cyrillic fonts GOST 2.304-81 type A.ttf and GOST 2.304-81 type B.ttf are located in the C:\Windows\Fonts folder, not the ..\ProgramData\Trimble\Tekla Structures\<<version>\environments\common\fonts folder.

See also

[Initialization files \(.ini files\) \(page 271\)](#)

6.11 Symbol files

Symbols are used for example in various places in drawings, for example, as separate objects, and in marks.

You can create symbols with Symbol Editor. In this case, the file name extension is .sym. You can also use symbols of .dwg format.

Tekla Structures symbol files are by default located in the folder ..\environments\common\symbols.

6.12 Files related to templates, reports and drawings

Tekla Structures has several files that relate to templates, reports, drawings and printing.

File or file type	Description	Location
.rpt	Report templates (page 366) created with the Template Editor	System folders defined for the advanced option XS_SYSTEM
.tpl	Drawing templates (page 366) created with the Template Editor	Template folders defined for the advanced option XS_TEMPLATE_DIRECTORY

File or file type	Description	Location
.lay	Layout definitions created with the Drawings & reports --> Drawing properties --> Drawing layout editor command.	The \attributes sub-folder in the model folder
plotdev.bin	Printer device definitions created with the Printer Catalog printer instances.	System folders defined for the advanced option XS_SYSTEM
xdproc	Master Drawing Catalog rule set	System folders defined for the advanced option XS_SYSTEM
xdproc.master	Master Drawing Catalog master drawing file	System folders defined for the advanced option XS_SYSTEM
xdproc.master.png	Master Drawing Catalog sample (preview) image files	System folders defined for the advanced option XS_SYSTEM
xdproc.png	Master Drawing Catalog thumbnail image files	System folders defined for the advanced option XS_SYSTEM

For more information about the folder search order, see [Folder search order \(page 361\)](#).

Note that default drawing, report, and template files are read from the system folders defined with XS_SYSTEM (or from the XS_TEMPLATE_DIRECTORY folders), but user-defined files are stored in the model's \attributes folder.

6.13 Image files

Tekla Structures uses image files in several places, such as:

- In templates in drawings
- In drawing snapshots
- In component dialog boxes and thumbnails
- In drawing line types
- In the surface treatment dialog box
- In the **Master Drawing Catalog** for thumbnails and sample images

- In profile properties dialog boxes

The following image file formats are supported in Tekla Structures:

- In templates: bmp, gif, grd, jpg, ppm, pgm, rle, tiff and xkrl
- In drawing snapshots, and int thumbnail and sample images for the **Master Drawing Catalog**: png
- Other situations: bmp

See also

[Add images in a template \(page 381\)](#)

6.14 Log files

Tekla Structures writes information to log files when you, for example, number a model or save a model.

File	Description
analysis.log	Tekla Structures stores information in this file when you run the analysis. The file also contains information on the errors that occurred during load distribution. This log file is saved in the current model folder.
check_database.log	Tekla Structures stores information in this file when you run the Repair command in File menu --> Diagnose & repair --> Model . This log file is saved in the current model folder.
ClashCheck.log	Contains clashes found in the most recent clash check. This log file is saved in the current model folder.
ClientLog_cat.txt ClientLog_dog.txt	The client log files contain diagnostic information and error messages regarding the Tekla Model Sharing sharing service, such as connecting to the sharing service or the status of the sharing service. The client log files are saved in the \Users\ <user>\AppData\Local\Tekla DataSharing folder. The client log contains two log files with the maximum size of 1 megabyte, so that the information will not use too much disk space. When</user>

File	Description
	<p>the maximum file size is reached in the ClientLog_cat.txt file, log writing is switched to the ClientLog_dog.txt file, and the other way around. Each time the client log file is switched, any information previously saved in the current log file is cleared before any new log information is written into the log file.</p>
ComponentCatalog_<user>.log	<p>Contains troubleshooting information related to the Applications & components catalog and any errors that have occurred in the Applications & components catalog. For example, errors in the catalog definition files are stored in the ComponentCatalog_<user>.log file. This log file is saved in the \logs folder under the current model folder.</p> <p>Note that a limited number of older log messages (approximately 1024KB) related to the Applications & components catalog are archived and saved in the ComponentCatalog_<user>.bak.log file.</p>
conflict.log	<p>Contains conflicts that have occurred in the multi-user mode when more than a one user has modified an object. This log file is saved in the current model folder.</p>
DocumentManager_<user>.log	<p>Contains troubleshooting information related to the Document manager, and any errors that have occurred in the Document manager. This log file is saved in the \logs folder under the current model folder.</p> <p>Note that a limited number of older log messages (approximately 256KB) related to the Document manager are archived and saved in the DocumentManager_<user>.bak.log file.</p>

File	Description
DPMPrinter_<user>.log	<p>Contains troubleshooting information related to printing, and any errors that have occurred in printing drawings or reports to a printer, a plot file, or a PDF file. This log file is saved in the \logs folder under the current model folder.</p> <p>Note that a limited number of older log messages (approximately 1024KB) related to printing are archived and saved in the DPMPrinter2_<user>.log file.</p>
drawing_cloning.log	Contains information on cloned drawings. This log file is saved in the current model folder.
drawing_history.log	Contains information on drawing history. Use the advanced option XS_DRAWING_HISTORY_LOG_TYPE to define the contents of the file. This log file is saved in the current model folder.
dstv_nc.log	Each time you create NC files, Tekla Structures stores information in this file about the processed assemblies. This log file is saved in the current model folder.
error_<user>_<YYYYMMDD>_<HHMMSS>.log	Each time an error occurs in Tekla Structures, the error is saved in an error log file. Error log files contain the description of errors that have occurred at a particular time. For example, if an error has occurred on April 1, 2019 at 9:15:30 AM, the name of the related error log file is error_<user>_20190401_091530.log. This log file is saved in the \logs folder under the current model folder.
filetranerror.log	Used only for cold rolled components, such as Albion, Ayrshire, and Hispan. If the File Transfer components do not work as expected, Tekla Structures stores error messages in this file. This log file is saved in the current model folder.

File	Description
modelsharing.log	Contains the sharing operations that have been performed in Tekla Model Sharing. For example, opening a shared model and reading in the changes made by other users are stored in the <code>modelsharing.log</code> file. This log file is saved in the <code>\logs</code> folder under the current model folder.
numberinghistory.txt	Contains full details of each numbering session carried out on the model. Each session is in a different block of the file. This log file is saved in the current model folder.
PublishToTrimbleConnect.log	Contains upload information and the errors that have occurred when uploading the Tekla Structures model to a linked Trimble Connect project as a <code>.tekla</code> file. This log file is saved in the <code>\logs</code> folder under the current model folder.
save_history.log	Tekla Structures stores information in this file each time you save a model. This log file is saved in the current model folder.
sharingfacade.log	Contains the essential information from the client log files when an error has occurred in the Tekla Model Sharing sharing service. This log file is saved in the <code>\logs</code> folder under the current model folder.
TeklaStructures_<user>.log	Contains information on the entire Tekla Structures session from opening the model to closing it. The file contains, for example, errors and information on which catalogs were used. This temporary log file is saved in the <code>\TeklaStructuresModels</code> folder, and it is removed when you close Tekla Structures.
UserFeedbackLog.txt	Contains the usage data on how you use Tekla Structures. This log file is

File	Description
	<p>saved in the \TeklaStructuresModels folder.</p> <p>Note that the UserFeedbackLog.txt log file is always opened with the default text editor, unlike other log files which can be opened through Tekla Structures log viewer. The option to switch between the viewers does not work for the UserFeedbackLog.txt file.</p>
wizard.log	<p>Tekla Structures stores information in this file when you run a drawing rule set (wizard) file. The file contains, for example, errors and number of drawings created. This log file is saved in the current model folder.</p>

See also

[View a log file \(page 331\)](#)

[Change the name and location of session history log file \(page 332\)](#)

[Numbering history log file \(page 333\)](#)

[Numbering series in the numbering history log file \(page 335\)](#)

View a log file

You can select how Tekla Structures displays the log files. Also, if parts or assemblies are listed in a log file, you can check the parts or assemblies in the model by selecting them in the log file.

1. Open the model whose log history you want view.
2. On the **File** menu, click **Logs** and select a log file you want to see.
 - **Clash Check history log** (ClashCheck.log)
 - **Session history log** (TeklaStructures_<user>.log)
 - **Numbering history log** (numberinghistory.txt)
 - **Saving history log** (save_history.log)
 - **Drawing history log** (drawing_history.log)
 - **Analysis history log** (analysis.log)
 - **Usage data log** (UserFeedbackLog.txt)

You can view the log file either in Tekla Structures log viewer, or in a viewer that has been associated with the file type, for example, in Microsoft Notepad.

To view the log file in the log viewer, in **File** --> **Logs** select **View with Tekla Structures log viewer**

To view the log file in an associated viewer, **File** --> **Logs** select **View with default application**.

The `UserFeedbackLog.txt` log file can be viewed only in associated viewer, not in the log viewer.

3. If the log file contains information about parts or assemblies, you can check the parts or assemblies in the model. In the log file, select a row which contains a part or an assembly.

Parts and assemblies have the prefix `guid`.

Tekla Structures highlights the part in the model. If there are several parts or assemblies on a row and you select that row, Tekla Structures highlights all the parts in the model. You can also select parts on different rows.

TIP You can access a part's or an assembly's pop-up menu from the log file by right-clicking a row that contains a part or an assembly. Tekla Structures displays the same pop-up menu as when you right-click a part or an assembly in the model.

See also

[Log files \(page 327\)](#)

[Change the name and location of session history log file \(page 332\)](#)

[Numbering history log file \(page 333\)](#)

Change the name and location of session history log file

You can change the name and location of the session history log file (`TeklaStructures_<user>.log`).

If someone else manages your installation of Tekla Structures, do not change these settings unless you are instructed to do so.

Windows username and the `.log` file extension are always added after the customizable part of the name.

1. Open a suitable [initialization file \(page 271\)](#) for editing.
For example, `user.ini` or `company.ini`.
2. To change the **name** of the session history log file, add the following line to the initialization file:

```
set XS_LOG_FILE_NAME=<name of the file>
```

For example:

```
set XS_LOG_FILE_NAME=sessionhistory
```

If the Windows user name is "achilles", this example would result in a log file named `sessionhistory_achilles.log`.

The default name is `TeklaStructures_<user>.log`.

3. To change the **location** of the session history log file, add the following line to the initialization file:

```
set XS_LOGPATH=<location of the file>
```

If there is no other location set, the file is stored in the parent folder for model folders (by default `c:\TeklaStructuresModels`).

4. Save the initialization file.
5. Restart Tekla Structures for the changes to take effect.

See also

[Log files \(page 327\)](#)

[View a log file \(page 331\)](#)

Numbering history log file

The `numberinghistory.txt` log file contains full details of each numbering session carried out on the model. Each numbering session is in a different block of the file.

NOTE If you remove or delete the `numberinghistory.txt` log file, Tekla Structures generates a new file with the same name next time when you run numbering. The new file does not contain a history of previous numbering sessions.

Example

Below is an example of the contents of a `numberinghistory.txt` log file.

```
① *** Numbering (haka): Thu Jun 14 13:08:08 2012
② Modified numbering
③ Compare modified to old parts
④ Compare new to old parts
④ Check for standard parts
  Use old numbers
⑤ Tolerance: 1.000000
  SteelTolerance: 1.000000
  ConcreteTolerance: 2.000000
  RebarTolerance: 2.000000
⑥ Part      guid: ID510F595D-0000-0017-3133-353939383237  series:Concrete_C-1/1  Concrete_C-1/0 -> Concrete_C-1/1
  Assembly guid: ID510F595D-0000-0016-3133-353939383237  series:C/1  C/0 -> C/1
  *** Operation finished Thu Jun 14 13:08:08 2012
```

1	User name, date and time of the numbering.
---	--

2	<p>Numbering method.</p> <ul style="list-style-type: none"> • Modified numbering is displayed when you run the Number modified objects command. • Modified numbering for selected series is displayed when you run the Number series of selected objects command. • Diagnose & Repair Numbering: All is displayed when you run the Diagnose & repair numbering: All command. • Diagnose & Repair Numbering: Series of selected objects is displayed when you run the Diagnose & repair numbering: Series of selected objects command. • Renumber all is displayed when you select the Renumber all option in the Numbering Setup dialog box.
3	<p>Some Compare options set in the Numbering Setup dialog box are displayed in the <code>numbering.history</code> log file only if they are set differently than the default value:</p> <ul style="list-style-type: none"> • Compare modified to old parts • Compare new to old part • No holes comparing • No part name comparing • Beam orientation • Column orientation <p>Some Compare options are not displayed at all:</p> <ul style="list-style-type: none"> • Reinforcing bars • Embedded objects • Surface treatment
4	<p>Numbering options.</p> <ul style="list-style-type: none"> • Use old numbers is displayed only when you have selected the Re-use old numbers option in the Numbering Setup dialog box. • Check for standard parts is displayed only when you have selected the Check for standard parts option in the Numbering Setup dialog box.
5	<p>Tolerances are set in the Numbering Setup dialog box.</p>
6	<p>Changes in the position numbers and in the numbering series during one numbering session.</p>

	<p>In addition:</p> <p>If a numbering series overlaps another, the errors are written to the log file.</p>
--	--

See also

[Numbering series in the numbering history log file \(page 335\)](#)

Numbering series in the numbering history log file

Tekla Structures lists information on the numbered parts and assemblies in the `numberinghistory.txt` log file.

Example 1

The `numberinghistory.txt` log after one concrete beam **B/20** has been created and numbered:

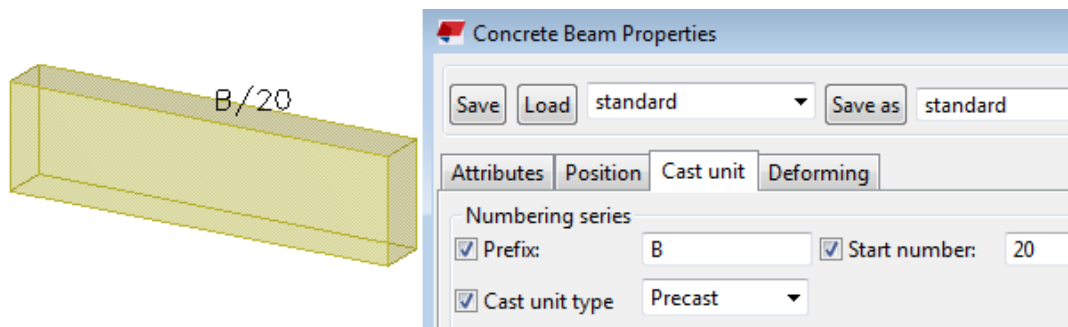

```

1 Part      guid: ID510F595D-0000-0030-3133-353939383335 series:Concrete_B-20/1 Concrete_B-20/0 -> Concrete_B-20/1
2 Assembly guid: ID510F595D-0000-002F-3133-353939383335 series:B/20 B/0 -> B/20
  
```

1	<p>Part position number.</p> <ul style="list-style-type: none"> The part with the GUID ID510F595D-0000-0030-3133-353939383335 is a part of the numbering series <code>Concrete_B-20/1</code>. The part becomes the first part in the numbering series: <code>Concrete_B-20/0 -> Concrete_B-20/1</code>.
2	<p>Assembly position number.</p> <ul style="list-style-type: none"> The assembly ID of the part is ID510F595D-0000-002F-3133-353939383335. The part belongs to the <code>B/20</code> assembly numbering series, which is also the cast unit numbering series. The part gets the assembly position number: <code>B/20: B/0 -> B/20</code>.

Example 2

The `numberinghistory.txt` log after another concrete beam **B/21** has been created and numbered:

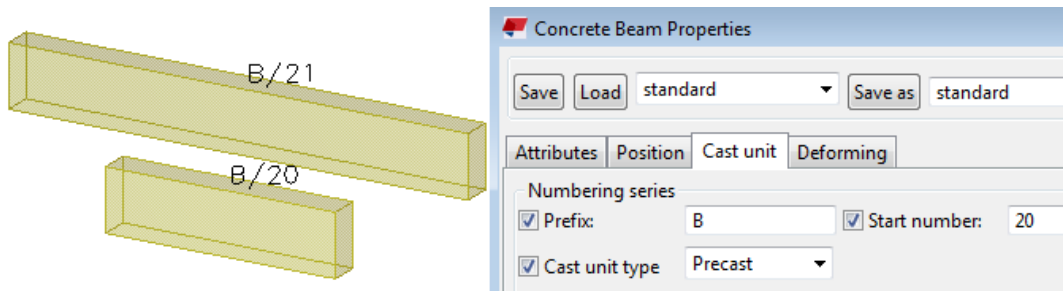

① Part guid: ID510F595D-0000-0030-3133-353939383335 series:Concrete_B-20/1 Concrete_B-20/0 -> Concrete_B-20/2
② Assembly guid: ID510F595D-0000-002F-3133-353939383335 series:B/20 B/0 -> B/21

1	Part position number of the new part. <ul style="list-style-type: none">The part with the ID ID510F595D-0000-0030-3133-353939383335 is part of the numbering series Concrete_B-20/1.The part becomes the second part in the numbering series: Concrete_B-20/0 -> Concrete_B-20/2.
2	Assembly position number. <ul style="list-style-type: none">The assembly ID of the part is ID510F595D-0000-002F-3133-353939383335.The part belongs to the B/20 assembly numbering series, which is also the cast unit numbering series.The part gets the assembly position number: B/20 B/0 -> B/21.

See also

[Numbering history log file \(page 333\)](#)

6.15 Model folder files and file name extensions

The following tables list the folders, files and file name extensions of files located in a Tekla Structures model folder.

Files in the Tekla Structures model folder

File or file name extension	Description
.db1	Model database
.db2	Numbering database
environment.db	Database for user-defined attribute definitions
xslib.db1	Contains information on user-defined connections and details, and default component descriptions.
.idrm	Mapping file, which handles IDs. Do not modify.
xslib.db2	Contains numbering information.
options_model.db and options_drawings.db	Contain values for model-specific options from the Options dialog box and values for model-specific advanced options from the Advanced Options dialog box. When a model is created, Tekla Structures reads model-specific options and advanced options values from the <code>standard.opt</code> file and <code>.ini</code> files in the environment folders and saves them in these two databases.
history.db	Model history database.
xldb.xs	File used for displaying the name of the model in the Open dialog box.
xs_user.<username>	<p>Contains interface settings specified by the user.</p> <p>Each time a model is saved, an <code>xs_user.<username></code> file is created or updated. These settings are user specific. If the <code>xs_user.<username></code> file is not found in the model folder when you open the model, Tekla Structures searches for the <code>xs_user.default</code> file in the following folder search order: model, model\attributes, project, XS_FIRM\attributes, system. If this file is not found, Tekla Structures default settings will be used.</p> <p>This file contains settings for many of the options in the Options dialog box</p>

File or file name extension	Description
	and the settings for the icons on the Selecting and Snapping toolbars.
drawing_user.<username>	Contains information on which snap switches are switched on or off in the drawing mode. This file is user specific. Do not modify this file.
save_history.log	Tekla Structures stores the information in this file each time the model is saved. The file includes the saving time, date and information on any conflicts during saving.
notification_report.xsr	File used for displaying a notification report of assignments when you open a model.
TeklaStructuresModel.xml	<p>Contains a copy of basic details about the Tekla Structures model, for example the model name, version it was last saved with, and the Tekla Structures environment. Tekla Structures overwrites the details in this file each time the model is saved.</p> <p>The model details that you see when you select a model on the startup screen are read from this file. The file can also be used as an information source for external tools, such as scripts.</p>
dotlog.txt	A log file that contains information on Tekla Open API application use.
.locked	A temporary file that locks the model folder files to prevent modifications while the model is in use.
.bak	<p>A backup copy of a file with a corresponding name.</p> <p>For example, the <modelname>.db1.bak file is the backup copy of the model database file <modelname>.db1.</p>
assert.txt	A log file that contains information on assertion errors.
ClashCheck.txt	A log file that contains information on clashes found in the most recent clash check and the date and time of the clash check.

File or file name extension	Description
ClashCheck.history	A file that contains information on all clashes found in all clash checks and the dates and times of the clash checks.
wizard.txt	Tekla Structures stores information in this file when you run a drawing rule set (wizard) file. The file contains, for example, errors, number of drawings created, and information on which commands were used.
.lis	Different catalogs can be exported from and imported to different Tekla Structures models as .lis files. These include profile, material and bolt catalogs.
.tsc	Shapes can be exported from and imported to different Tekla Structures models as .tsc files.
.This_is_multiuser_model	Contains information about the PC running the Tekla Structures multi-user server. Do not alter or delete this file in normal circumstances. If you move a model to a different server, you should delete this file. Tekla Structures generates a new file with the same name.
ComponentCatalog.xml	Contains the model level catalog definitions of the Applications & components catalog.
<user>_ComponentCatalogUserSettings.xml	Lists the recently used applications and components, and their location in the Applications & components catalog structure.
Worktypes.xml	Lists available task types. Created when you start Task Manager .
WorkTypeProperties.xml	Lists allowed property types and their units.
.tmp	A file used to store temporary data.
.cnv	A file used to map Tekla Structures profile and material names with names used in other software.

File or file name extension	Description
.colorset	Created when you export a color set from Organizer .

Files in the \Analysis folder

File or file name extension	Description
.ifc	The analysis model exported in IFC format.
.stp	The analysis model exported in CIS/2 format.
.map	A file used for debugging analysis models.
analysis_results.db5	Database that contains saved analysis results for all load combinations.
.db6	Analysis model database.

Files in the \attributes folder

File or file name extension	Description
.rmcs	Comparison set files used in reference model change detection.
.rmct	Property set comparison tolerance setting files used in reference model change detection.
.rop	Reference object properties
.rop.more	Reference object user-defined attribute properties
.m10000017	FabTrol XML import properties
.m10000015	Import attribute properties
.ncf	NC file properties
.ExportIFC.MainDialog	IFC export properties
.m440000004	3D DWG/DXF export properties
.m440000003	3D DGN export properties
.m1000004	FEM export properties
.m10000011	CIS analysis model export properties
.m10000026	CIS manufacturing model export properties
.m1000007	CAD export properties

File or file name extension	Description
.m10000016	Cover sheet export properties
.SObjGrp	Model selection filter properties
.VObjGrp	Model view filter properties
.OrgObjGrp	Organizer filter properties
.PObjGrp	Object group filter properties
.grd	Rectangular grid properties
.grd.more	Rectangular grid user-defined attribute properties
.rgrd	Radial grid properties
.rgrd.more	Radial grid user-defined attribute properties
.grdp	Grid line properties
.grdp.more	Grid line user-defined attribute properties
.cnl	Construction line properties
.cncrl	Construction circle properties
.cnarc	Construction arc properties
.cnplycrv	Construction polycurve properties
.mvi	<p>Model view properties that you have saved for the model.</p> <p>Default 3D, part, component, custom component, assembly, and cast unit view settings files need to be saved with names used in common environment:</p> <p>3D view: basic_view</p> <p>3D part view: part_basic_view</p> <p>Part front view: part_front_view</p> <p>Part top view: part_top_view</p> <p>Part end view: part_end_view</p> <p>Part perspective view: part_persp_view</p> <p>3D component view: component_basic_view</p> <p>Component front view: component_front_view</p> <p>Component top view: component_top_view</p>

File or file name extension	Description
	<p>Component end view: component_end_view</p> <p>Component perspective view: component_persp_view</p> <p>Custom component front view: custom_object_editor_front_view</p> <p>Custom component top view: custom_object_editor_top_view</p> <p>Custom component end view: custom_object_editor_end_view</p> <p>Custom component perspective view: custom_object_editor_perspective_view</p> <p>3D assembly or cast unit view: assembly_basic_view</p> <p>Assembly or cast unit front view: assembly_front_view</p> <p>Assembly or cast unit top view: assembly_top_view</p> <p>Assembly or cast unit end view: assembly_end_view</p> <p>Assembly or cast unit back view: assembly_back_view</p> <p>Assembly or cast unit bottom view: assembly_bottom_view</p> <p>Assembly or cast unit perspective view: assembly_persp_view</p>
.gvi	Saved properties for creating views along grid lines
.rep	Object representation properties
.clm	Steel column properties
.clm.more	Steel column user-defined attribute properties
.prt	Steel beam properties
.prt.more	Steel beam user-defined attribute properties
.sb	Steel spiral beam properties
.sb.more	Steel spiral beam user-defined attribute properties

File or file name extension	Description
.crs	Orthogonal beam properties
.crs.more	Orthogonal beam user-defined attribute properties
.dia	Twin profile properties
.dia.more	Twin profile user-defined attribute properties
.cpl	Contour plate properties
.cpl.more	Contour plate user-defined attribute properties
.blp	Bent plate properties
.blp.more	Bent plate user-defined attribute properties
.lpl	Lofted plate properties
.lpl.more	Lofted plate user-defined attribute properties
.ips	Item properties
.ips.more	Item user-defined attribute properties
.cpf	Pad footing properties
.cpf.more	Pad footing user-defined attribute properties
.csf	Strip footing properties
.csf.more	Strip footing user-defined attribute properties
.ccl	Concrete column properties
.ccl.more	Concrete column user-defined attribute properties
.cbm	Concrete beam or concrete polybeam properties
.cbm.more	Concrete beam or concrete polybeam user-defined attribute properties
.csb	Concrete spiral beam properties
.csb.more	Concrete spiral beam user-defined attribute properties
.csl	Concrete slab properties
.csl.more	Concrete slab user-defined attribute properties
.cpn	Concrete panel properties
.cpn.more	Concrete panel user-defined attribute properties

File or file name extension	Description
.lsl	Concrete lofted slab properties
.lsl	Concrete lofted slab user-defined attribute properties
.ipc	Concrete item properties
.ipc.more	Concrete item user-defined attribute properties
.rbr	Reinforcing bar properties
.rbr.more	Reinforcing bar user-defined attribute properties
.rbg	Reinforcing bar group properties
.rbg.more	Reinforcing bar group user-defined attribute properties
.rcu .rcu.more	Curved reinforcing bar group properties and user-defined attributes
.rci .rci.more	Circular reinforcing bar group properties and user-defined attributes
.rbm	Reinforcement mesh properties
.rbm.more	Reinforcement mesh user-defined attribute properties
.rbs	Reinforcement strand pattern properties
.rbs.more	Reinforcement strand pattern user-defined attribute properties
.rsp	Reinforcement splice properties
.rsp.more	Reinforcement splice user-defined attribute properties
.rst	Rebar set properties
.rst.more	Rebar set user-defined attribute properties
.rst_ls	Rebar set leg surface properties
.rst_pm	Rebar set property modifier properties
.rst_pm.more	Rebar set property modifier user-defined attribute properties
.rst_edm	Rebar set end detail modifier properties
.rst_edm.more	Rebar set end detail modifier user-defined attribute properties

File or file name extension	Description
.rst_sm	Rebar set splitter properties
.admodel	Analysis model properties
.admodel.more	Analysis model user-defined attribute properties
.lm1	Point load properties
.lm2	Line load properties
.lm3	Area load properties
.lm4	Uniform load properties
.m10000028	Wind load properties
.lm6	Temperature load properties
.lco	Load combination properties
.adnode	Analysis node properties
.adnode.more	Analysis node user-defined attribute properties
.prt_ad, .prt_design	File types associated with steel beam analysis property settings. .prt_ad contains information associated with the analysis part properties and .prt_design contains information associated with the actual steel beam design.
.crs_ad, .crs_design	File types associated with orthogonal steel beam analysis property settings. .crs_ad contains information associated with the analysis part properties and .crs_design contains information associated with orthogonal steel beam design.
.clm_ad, .clm_design	File types associated with steel column analysis property settings. .clm_ad contains information associated with the analysis part properties and .clm_design contains information associated with the actual steel column design.
.dia_ad, .dia_design	File types associated with steel twin profile analysis property settings. .dia_ad contains information associated with the analysis part properties

File or file name extension	Description
	and <code>.dia_design</code> contains information associated with actual twin profile design.
<code>.cpl_ad, .cpl_design</code>	File types associated with contour plate analysis property settings. <code>.cpl_ad</code> contains information associated with the analysis part properties and <code>.cpl_design</code> contains information associated with actual contour plate design.
<code>.cpf_ad, .cpf_design</code>	File types associated with pad footing analysis property settings. <code>.cpf_ad</code> contains information associated with the analysis part properties and <code>.cpf_design</code> contains information associated with the actual pad footing design.
<code>.csf_ad, .csf_design</code>	File types associated with strip footing analysis property settings. <code>.csf_ad</code> contains information associated with the analysis part properties and <code>.csf_design</code> contains information associated with the actual strip footing design.
<code>.ccl_ad, .ccl_design</code>	File types associated with concrete column analysis property settings. <code>.ccl_ad</code> contains information associated with the analysis part properties and <code>.ccl_design</code> contains information associated with the actual concrete column design.
<code>.cbm_ad, .cbm_design</code>	File types associated with concrete beam analysis property settings. <code>.cbm_ad</code> contains information associated with the analysis part properties and <code>.cbm_design</code> contains information associated with the actual concrete beam design.
<code>.csl_ad, .csl_design</code>	File types associated with concrete slab analysis property settings. <code>.csl_ad</code> contains information associated with the

File or file name extension	Description
	analysis part properties and <code>.csl_design</code> contains information associated with the actual slab design.
<code>.cpn_ad, .cpn_design</code>	File types associated with concrete panel analysis property settings. <code>.cpl_ad</code> contains information associated with the analysis part properties and <code>.cpl_design</code> contains information associated with the actual concrete panel design.
<code>.srf</code>	Surface treatment properties
<code>.srf.more</code>	User-defined surface treatment attribute properties
<code>.srfo</code>	Surface properties
<code>.srfo.more</code>	User-defined surface attribute properties
<code>.cha</code>	Edge chamfer properties
<code>.cha.more</code>	User-defined edge chamfer attribute properties
<code>.scr</code>	Bolt properties
<code>.scr.more</code>	User-defined bolt attribute properties
<code>.wld</code>	Weld properties
<code>.wld.more</code>	User-defined weld attribute properties
<code>*.udwcs</code>	User-defined weld cross sections (UserDefinedWeldCrossSections.udwcs)
<code>.m1000009</code>	Control number properties
<code>.m1000010</code>	Control number locking properties
<code>.num</code>	Numbering setup properties
<code>.rpr</code>	Report properties
<code>.4d</code>	Project status visualization properties
<code>.sas</code>	Assembly properties
<code>.pas</code>	Precast cast unit properties
<code>.ias</code>	Cast-in-place cast unit properties
<code>.ras</code>	Rebar assembly properties
<code>.punit</code> <code>.punit.more</code>	Pour unit properties and user-defined attributes

File or file name extension	Description
.pour .pour.more	Pour object properties and user-defined attributes
.pbreak	Pour break properties
standard.opt	Settings are saved in <code>standard.opt</code> in the <code>\attributes</code> folder only when you save your own settings in the Options dialog box using Save . There is a <code>standard.opt</code> file in the environment folder that gives the initial values to be loaded when a model is created.

Component properties files in the \attributes folder

Properties files for components available in the **Applications & components** catalog, for example `.j310000063` for **2L Splice (63)** component properties. These files are stored in the `attributes` folder under the model folder.

Object level drawing settings, saved in \attributes folder

File or file name extension	Description
.dprt	Object level part properties
.dim	Object level dimension properties
.dimension_mark	Object level dimension tag properties
.rdim	Object level rebar dimension mark properties
.pm	Object level part mark properties
.jm	Object level connection mark properties
.sm	Object level bolt mark properties
.rm	Object level reinforcement mark properties
.mrms	Object level merged reinforcement mark properties
.pom	Pour object mark properties
.surfm	Object level surface treatment mark properties

File or file name extension	Description
.note	Object level associative note properties
.wls	Object level weld mark properties
.lev	Object level level mark properties
.rev	Object level revision mark properties
.drmesh	Object level reinforcement mesh properties
.drbr	Object level reinforcement properties
.po	Object level pour object properties
.sc	Object level bolt properties
.dsrf	Object level surface treatment properties
.dgr	Object level grid properties
.sbl	Object level symbol properties
.wls	Object level weld mark properties
.drtxt	Object level text properties
.gln	Object level line properties
.grt	Object level rectangle properties
.gci	Object level circle properties
.gar	Object level arc properties
.gpl	Object level polyline properties
.gpg	Object level polygon and cloud properties

View level drawing settings, saved in \attributes folder

File or file name extension	Description
.vi .vi.copt	View level view properties
.vclassif .vclassif.copt	View level detailed object level settings
.vpm	View level part mark properties
.vsm	View level bolt mark properties
.vnpm	View level neighbor part mark properties
.vsurfm	View level surface treatment mark properties

File or file name extension	Description
.vjm	View level connection mark properties
.vrm	View level reinforcement mark properties
.vnrm	View level neighbor reinforcement mark properties
.vpom	View level pour object mark properties
.vp	View level part properties
.vs	View level bolt properties
.vnp	View level neighbor part properties
.vsurf	View level surface treatment properties
.vw	View level welding properties
.vr	View level reinforcement properties
.vnr	View level neighbor reinforcement properties
.vrmp	View level reference object properties
.vpo	View level pour object properties
.vg	View level grid properties
.vf	View level filter properties
.vnf	View level neighbor part filter properties

Files related to single-part drawings, drawing level properties, saved in \attributes folder

File or file name extension	Description
.wd .wd.copt	Single-part drawing properties
.wd.more	Single-part drawing user-defined attributes
.wdf	Single-part drawing filter properties
.wdnf	Single-part drawing neighbor part filter properties
.wdl	Single-part drawing layout properties
.wdl.more	Single-part drawing user-defined layout attributes

File or file name extension	Description
.wdv	Single-part drawing view properties
.wdv.more	Single-part drawing user-defined view attributes
.wdc	Single-part drawing section view properties
.wdc.more	Single-part drawing user-defined section view attributes
.wdd	Single-part drawing dimension properties
.wdd.more	Single-part drawing user-defined dimension attributes
.wdcd	Single-part drawing dimensioning properties
.wdcd more	Single-part drawing user-defined dimensioning attributes
.wpm	Single-part drawing part mark properties
.wsm	Single-part drawing bolt mark properties
.wnpm	Single-part drawing neighbor part mark properties
.wdsurfm	Single-part drawing surface treatment mark properties
.wdsurfm.more	Single-part drawing user-defined surface treatment mark attributes
.wjm	Single-part drawing connection mark properties
.wdp	Single-part drawing part properties
.wds	Single-part drawing bolt properties
.wds.more	Single-part drawing user-defined bolt attributes
.wdnp	Single-part drawing neighbor part properties
.wdnp.more	Single-part drawing user-defined neighbor part attributes
.wdsrf	Single-part drawing surface treatment properties
.wdsrf.more	Single-part drawing user-defined surface treatment attributes
.wdgr	Single-part drawing grid properties

File or file name extension	Description
.wdgr.more	Single-part drawing user-defined grid attributes
.wdr	Single-part drawing protection properties
.wdr.more	Single-part drawing user-defined protection attributes

Files related to assembly drawings, drawing level properties, saved in \attributes folder

File or file name extension	Description
.ad	Assembly drawing properties
.ad.more	Assembly drawing user-defined attributes
.adf	Assembly drawing filter properties
.adnf	Assembly drawing neighbor part filter properties
.adl	Assembly drawing layout properties
.adl.more	Assembly drawing user-defined layout attributes
.adv	Assembly drawing view properties
.adc	Assembly drawing section view properties
.add	Assembly drawing dimension properties
.add.more	Assembly drawing user-defined dimension attributes
.adcd	Assembly drawing dimensioning properties
.adcd.more	Assembly drawing user-defined dimensioning attributes
.apm	Assembly drawing part mark properties
.asm	Assembly drawing bolt mark properties
.anpm	Assembly drawing neighbor part mark properties
.adsurfm	Assembly drawing surface treatment mark properties

File or file name extension	Description
.adsurfm.more	Assembly drawing user-defined surface treatment mark attributes
.ajm	Assembly drawing connection mark properties
.adp	Assembly drawing part properties
.adp.more	Assembly drawing user-defined part attributes
.ads	Assembly drawing bolt properties
.adnp	Assembly drawing neighbor part properties
.adnp.more	Assembly drawing user-defined neighbor part attributes
.adsrf	Assembly drawing surface treatment properties
.adsrf.more	Assembly drawing user-defined surface treatment attributes
.adw	Assembly drawing welding properties
.adw.more	Assembly drawing user-defined welding attributes
.adgr	Assembly drawing grid properties
.adgr.more	Assembly drawing user-defined grid attributes
.adr	Assembly drawing protection properties

Files related to cast unit drawings, drawing level properties, saved in \attributes folder

File or file name extension	Description
.cud .cud.copt	Cast unit drawing properties
.cud.more	Cast unit drawing user-defined attributes
.cudl	Cast unit drawing layout properties
.cudl.more	Cast unit drawing user-defined layout attributes
.cudv	Cast unit drawing view properties
.cudv.more	Cast unit drawing user-defined view attributes

File or file name extension	Description
.cudc	Cast unit drawing section view properties
.cudc.more	Cast unit drawing user-defined section view attributes
.cudd	Cast unit drawing dimension properties
.cudd.more	Cast unit drawing user-defined dimension attributes
.cudcd	Cast unit drawing dimensioning properties
.cudcd.more	Cast unit drawing user-defined dimensioning properties
.cupm	Cast unit drawing part mark properties
.cusm	Cast unit drawing bolt mark properties
.cunpm	Cast unit drawing neighbor part mark properties
.cudsurfm	Cast unit drawing surface treatment mark properties
.cudsurfm.more	Cast unit drawing user-defined surface treatment mark attributes
.cudrm	Cast unit drawing reinforcement mark properties
.cudrm.more	Cast unit drawing user-defined reinforcement mark attributes
.cudp	Cast unit drawing part properties
.cudp.more	Cast unit drawing user-defined part attributes
.cuds	Cast unit drawing bolt properties
.cuds.more	Cast unit drawing user-defined bolt attributes
.cudnp	Cast unit drawing neighbor part properties
.cudnp.more	Cast unit drawing user-defined neighbor part attributes
.cudsurf	Cast unit drawing surface treatment properties
.cudsurf.more	Cast unit drawing user-defined surface treatment attributes

File or file name extension	Description
.cudr	Cast unit drawing reinforcement properties
.cudr.more	Cast unit drawing user-defined reinforcement attributes
.cudw	Cast unit drawing welding properties
.cudw.more	Cast unit drawing user-defined welding attributes
.cudgr	Cast unit drawing grid properties
.cudgr.more	Cast unit drawing user-defined grid attributes
.cudrp	Cast unit drawing protection properties
.cudrp.more	Cast unit drawing user-defined protection attributes
.cuf	Cast unit drawing filter properties
.cunf	Cast unit drawing neighbor part filter properties

Files related to general arrangement drawings, drawing level properties, saved in \attributes folder

File or file name extension	Description
.gd .gd.copt	General arrangement drawing properties
.gclassif .gclassif.copt	General arrangement drawing detailed object level settings
.gd.more	General arrangement drawing user-defined properties
.gdl	General arrangement drawing layout properties
.gdl.more	General arrangement drawing user-defined layout attributes
.gdv	General arrangement drawing view properties
.gdv.more	General arrangement drawing user-defined view attributes
.gdd	General arrangement drawing dimension properties

File or file name extension	Description
.gdd.more	General arrangement drawing user-defined dimension attributes
.gdcd	General arrangement drawing dimensioning properties
.gdcd.more	General arrangement drawing user-defined dimensioning attributes
.gpm	General arrangement drawing part mark properties
.gsm	General arrangement drawing bolt mark properties
.gnpm	General arrangement drawing neighbor part mark properties
.gdsurfm	General arrangement drawing surface treatment mark properties
.gdsurfm.more	General arrangement drawing user-defined surface treatment mark attributes
.gjm	General arrangement drawing connection mark properties
.gdrm	General arrangement drawing reinforcement mark properties
.gdrm.more	General arrangement drawing user-defined reinforcement mark attributes
.gnrm	General arrangement drawing neighbor reinforcement mark properties
.gpom	General arrangement drawing pour object mark properties
.gdp	General arrangement drawing part properties
.gdp.more	General arrangement drawing user-defined part attributes
.gds	General arrangement drawing bolt properties
.gds.more	General arrangement drawing user-defined bolt attributes
.gdnp	General arrangement drawing neighbor part properties
.gdnp.more	General arrangement drawing user-defined neighbor part attributes

File or file name extension	Description
.gdstrf	General arrangement drawing surface treatment properties
.gdw	General arrangement drawing welding properties
.gdw.more	General arrangement drawing user-defined welding attributes
.gdr	General arrangement drawing reinforcement properties
.gdr.more	General arrangement drawing user-defined reinforcement attributes
.gnr	General arrangement drawing neighbor reinforcement properties
.gpo	General arrangement drawing pour object properties
.gpbr	General arrangement drawing pour break properties
.gdrmp	General arrangement drawing reference object properties
.gdrmp.more	General arrangement drawing user-defined reference model attributes
.gdgr	General arrangement drawing grid properties
.gdgr.more	General arrangement drawing user-defined grid attributes
.gdrp	General arrangement drawing protection properties
.gdrp.more	General arrangement drawing user-defined protection attributes
.gdf	General arrangement drawing filter properties
.gdnf	General arrangement drawing neighbor part filter properties

Files related to multidrawings, drawing level properties, saved in \attributes folder

File or file name extension	Description
.md	Multidrawing properties
.md.more	Multidrawing user-defined attributes
.mdl	Multidrawing layout properties

File or file name extension	Description
.mdl.more	Multidrawing user-defined layout attributes
.mdr	Multidrawing protection properties
.mdr.more	Multidrawing user-defined protection attributes

Files common to all drawings, and files in the \drawings folder

File or file name extension	Description
.dg	Drawing files
.ldb	Drawing export layer properties
.ldr	Drawing link properties
.cs	Section symbol properties
.detail	Detail symbol properties
.fas	Text file properties
.fhl	Hyperlink properties
.dsf	Drawing selection filter properties. This file is saved when you select the Drawing --> Selection filter check box in the Filter or Selection Filter properties.
.GridsDimXml .ShapeDimXml .HolesDimXml .FilterDimXml .OverallDimXml .RecessesDimXml .SecPartsDimXml	Dimensioning rules
.dg.DPM	Drawing snapshot files in the \<model>\drawings\snapshots subfolder. The files are created either automatically or based on a user request. To create a snapshot of a drawing automatically at the same time that you create the drawing, set the the advanced option

File or file name extension	Description
	XS_DRAWING_CREATE_SNAPSHOT_ON_DRAWING_CREATION to TRUE. For more information about creating snapshots, see Snapshots in drawings.

Files related to IFC export in \IFC folder

File or file name extension	Description
.ifc	Exported IFC files

Files related to NC in the \DSTV_Profiles folder

File or file name extension	Description
.nc1	NC (numerical control) files

Files in the \ModelSharing folder

File or file name extension	Description
ModelSharingService.key	Key file that is needed to perform sharing in Tekla Model Sharing.
FileSharing.ini	File sharing settings in Tekla Model Sharing.
FileSharing.xml	File needed for file sharing in Tekla Model Sharing.

Files in the \ProjectOrganizer folder

File or file name extension	Description
.db	Created when Organizer is opened for the first time. Contains all property template and category information used in the model. The database name shows the version of the database, for example, ProjOrg000020.db.

File or file name extension	Description
.propertytemplate	Created when you export a property template from Organizer .
.category	Created when you export a category from Organizer .

Files related to reports in the \Reports folder

File or file name extension	Description
.xsr	Tekla Structures reports

Files in the \SessionFileRepository folder

File or file name extension	Description
Files in the SessionFileRepository folder	Backup copies of the files that are updated or deleted in Tekla Model Sharing read in.
SessionFile.db	Database for managing model folder files in Tekla Model Sharing.
.storage	Configuration file of SessionFile.db.

Files related to shapes in the \ShapeGeometries and \Shapes folders

File or file name extension	Description
.tez .xml	Shape geometry descriptions in the \ShapeGeometries folder.
.xml	Shape descriptions in the Shapes folder.

Files in the \screenshots folder

File or file name extension	Description
.png	Screenshot taken in Tekla Structures.

Files related to Unitechnik export in the \UT_files folder

File or file name extension	Description
.uni	Exported Unitechnik files

6.16 Check and change Tekla Structures file and folder locations in Directory browser

Directory browser is a tool that helps you to find and modify the location of the various Tekla Structures files and folders, and customize user settings.

NOTE Generally, only administrators should change these settings. If you change them yourself, and you are sharing the same model with other users, and your settings differ from those of the project, you will have problems. Also, adding or modifying files in some of these folders may require administrator rights.

To locate files and folders, and customize your Tekla Structures settings:

1. Click the **Applications & components** button  in the side pane to open the **Applications & components** catalog.
2. Click the arrow next to **Applications** to open the applications list.
3. Double-click **Directory browser**.

The **Directory browser** dialog box opens. You can check the most common folder paths, and customize the settings in your `user.ini` file, or in the user-specific or model-specific `options.ini` file.

4. Check the folder paths and change them if necessary by clicking the buttons on the left of the **Basic** tab.

If you click the **Project** or **Firm** button and you have not set your firm and project folder, Tekla Structures will prompt you to do so and add the folder path definition to your `user.ini` file.

5. Check the settings in the `user.ini` and `options.ini` files and change them if necessary by clicking the buttons on the right of the **Basic** tab.
6. Go to the **Advanced** tab and define the folder paths for additional folders that you may need to access, such as custom components and macros.

6.17 Folder search order

When you open a model, Tekla Structures searches for the associated files in specific folders in a set order.

It is important that you keep files in correct folders. Once Tekla Structures finds the associated files, it stops searching. This means that files that have the same name but are located lower down the search order are ignored.

The folder search order is:

Folder	Defined by
Current model	The open model
Project	Advanced option XS_PROJECT. If property files are stored in user-defined sub-folders under the project folder, Tekla Structures searches the sub-folders for files in alphabetical order. The first associated file is selected. After that, each file with the same file name suffix and file name prefix as the selected file is ignored. The names of the ignored files are stored in the error log.
Firm	Advanced option XS_FIRM. If property files are stored in user-defined sub-folders under the firm folder, Tekla Structures searches the sub-folders in alphabetical order. The first associated file is selected. After that, each file with the same file name suffix and file name prefix as the selected file is ignored. The names of the ignored files are stored in the error log.
System	Advanced option XS_SYSTEM

Tekla Structures does not search for certain files in exactly this order. The exceptions are listed below.

The exceptions are:

File (type)	Search order
objects.inp (page 306)	<ul style="list-style-type: none"> • Model folder • Project folder (XS_PROJECT) • Firm folder (XS_FIRM) • System folder (XS_SYSTEM)

File (type)	Search order
	<ul style="list-style-type: none"> • inp folder (XS_INP)
privileges.inp	<ul style="list-style-type: none"> • Model folder • Project folder (XS_PROJECT) • Firm folder (XS_FIRM) • System folder (XS_SYSTEM) • inp folder (XS_INP)
.dat files (page 316)	System folder (XS_SYSTEM)
Templates (page 366)	<ul style="list-style-type: none"> • Folder containing your templates indicated by the advanced option XS_TEMPLATE_DIRECTORY • Model folder • Project folder (XS_PROJECT) • Firm folder (XS_FIRM) • Environment-specific system templates indicated by the advanced option XS_TEMPLATE_DIRECTORY_SYSTEM • System folder (XS_SYSTEM)
Catalogs	<p>Profile (page 147), bolt (page 229), material (page 139), and rebar (page 246) catalogs:</p> <ul style="list-style-type: none"> • Model folder • Project folder (XS_PROJECT) • Firm folder (XS_FIRM) • Folder indicated by the advanced option XS_PROFDB <p>Shape catalog (page 210):</p> <ul style="list-style-type: none"> • Model folder • Project folder (XS_PROJECT) • Firm folder (XS_FIRM) • System folder (XS_SYSTEM) • Folder indicated by the advanced option XS_DEFAULT_BREP_PATH <p>Printer catalog:</p> <ul style="list-style-type: none"> • Model folder

File (type)	Search order
	<ul style="list-style-type: none"> • Project folder (XS_PROJECT) • Firm folder (XS_FIRM) • Folder indicated by the advanced option XS_DRIVER

WARNING Do not store customized files in the system folder. That way, you will avoid having problems or doing a lot of unnecessary work when you upgrade to a newer version of the software.

6.18 Location of certain hidden files and folders

When Tekla Structures is installed in the `..\Program Files` folder, some of the files needed to run Tekla Structures are located in hidden folders and are not therefore visible. You can see the hidden files and folders if you make them visible in the Windows **Folder Options**.

NOTE You can always check the settings below. If you run into problems with the settings, ask your administrator or local support for assistance.

Files related to the software

Software and, for example, the following files are installed under the `..\Program Files\Tekla Structures\<version>` folder.

- `contentattributes_global.lst`
- `contentattributes_userdefined.lst`
- (in the USA environment: `contentattributes_customer.lst`)

Files related to environments

Environments and, for example, the following files are installed under the `..\ProgramData\Trimble\Tekla Structures\<version>\environments\<environment>` folder. The exact file location may vary depending on the folder structure of your environment files.

- `analysis_design_config.inp`
- `contentattributes.lst`
- `dimension_marks.sym`
- `InquiryTool.config`
- `objects.inp`
- `objects.inp`

- privileges.inp
- product_finishes.dat
- rebar_config.inp
- TeklaStructures.lin
- TilePatternCatalog.dtd
- TilePatternCatalog.xml

Files related to user settings

User settings and, for example, the following files are installed under the `..\Users\<username>\AppData\Local\Trimble\Tekla Structures\<version>` folder.

- user.ini
- options.bin
- customized property pane layout PropertyTemplates.xml file
- customized ribbon and customized tab .xml files
- customized contextual toolbar .xml files
- customized toolbar .json files

See also

[Model folder files and file name extensions \(page 336\)](#)

7 Templates

Templates are descriptions of forms and tables that can be included in Tekla Structures. Templates are either graphical or textual. Graphical templates are inserted in drawing layouts as tables, text blocks, and drawing headers, for example. Textual templates are used for creating reports. The contents of the template fields are filled in by Tekla Structures at run time.

Tekla Structures includes a large number of standard templates you can use. Use Template Editor to modify existing templates, or create new ones to suit your needs.

Graphical template definitions have the file name extension `.tpl`. Textual template definitions have the file name extension `.rpt`.

The ready-made textual and graphical templates are located under the environment folders, in `... \ProgramData\Trimble\Tekla Structures \<version>\environments\`. The exact file location may vary depending on the folder structure of your environment files. Textual and graphical templates, except mark templates, can also be read from `XS_FIRM` or `XS_PROJECT` folders. For more information on where the templates are searched for, see [Folder search order \(page 361\)](#).

Examples

Example of a title block:

No	REV MARK	REVISION DESCRIPTION	CREATED	APPROVED	REV. DATE
					
DRAWING TITLE		STANDARD			
CONTRACT		Trimble Solutions Corporation			
MODELLED BY		Dean Designer	ISSUED		
CONTRACT NO		1	SCALE 1:10		A2
DRAWING No		[C.1]	REVISION No. 2		

Example of an inquiry report:

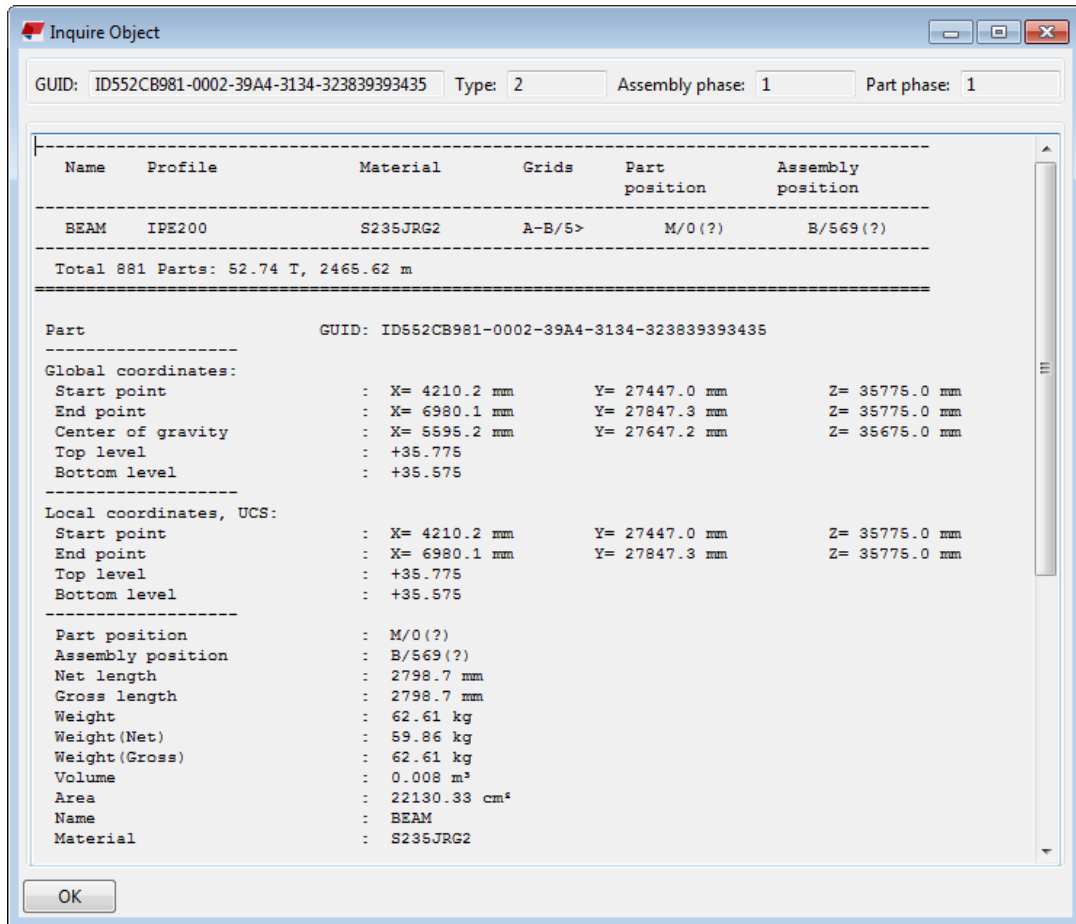

Example of a part list report:

Report

TEKLA STRUCTURES PARTS LIST FOR CONTRACT NO: 1 Page: 1
 CONTRACT: Trimble Solutions Co Date: 28.10.2016

PartPos	Profile	No.	Material	Length	Area (m2)	Weight (kg)
1001	PL10*230	2	S235JR	270	0.1	4.9
1002	PL20*140	10	S235JR	352	0.1	7.6
b/1	HEA300	1	S235JR	5590	9.6	493.7
c/1	HEA400	2	S235JR	7200	13.8	898.7
Total for 15 members:					38.6	2376.7

For more information on using templates, see [Template Editor User's Guide \(page 368\)](#) or open the Template Editor Help in Template Editor by clicking **Help --> Contents**.

See also

[Create a template \(page 368\)](#)

7.1 Create a template

1. On the **File** menu, click **Editors --> Template Editor**.
2. In Template Editor, click **File > New**.
3. Select the template type and click **OK**. A new empty template is created.
4. Add new rows in the template.
 - a. Click **Insert --> Component --> Row** to add a new row.
 - b. Select a content type for the row and click **OK**.
 - c. Repeat steps a–b for each new row.
5. Add value fields to get the required data from your Tekla Structures database.
 - a. Click **Insert --> Value field**.
 - b. Click a point to define the location of the field within the row.

The **Select Attribute** dialog box appears prompting you to select an attribute for the value field.
 - c. Select an attribute and click **OK**.
 - d. Repeat steps a–c for each value field.
6. Save the template.
 - a. Click **File --> Save as**.
 - b. Browse to the template folder defined for the advanced option `XS_TEMPLATE_DIRECTORY`.
 - c. In the **File name** field, enter a name for the template.
 - d. Click **OK**.

See also

[Templates \(page 366\)](#)

[Create a template in HTML format \(page 369\)](#)

[Create a template for nested assemblies \(page 373\)](#)

[Create a template for bending schedules or pull-out pictures \(page 377\)](#)

[Add images in a template \(page 381\)](#)

7.2 Template Editor User's Guide

This guide describes how you can use Template Editor to create, modify and manage template definitions for both reports and drawings.

With Template Editor, you can produce labels, reports and legends allowing you to gather and produce accurate and targeted information. Tekla Structures has a number of ready-made templates, and you can use Template Editor to modify the existing templates, or create new ones to suit your needs.

Template Editor is also used in other products than Tekla Structures. That is why the term 'product' is used frequently in the content instead of the actual software name. For exact instructions on how to use Template Editor together with Tekla Structures to create and modify templates, see the other articles under [Templates \(page 366\)](#).

The Template Editor User's Guide is currently available in English only. The content is the same as in the Template Editor help. Here is the guide in the PDF format: [Template Editor User's Guide](#).

7.3 Create a template in HTML format

Templates in HTML format give you more possibilities for different layout, fonts, and images. Templates that generate output in HTML format are graphical and have the file name extension *.html.rpt.

1. On the **File** menu, click **Editors --> Template Editor**.
2. In Template Editor, click **File > New**.
3. Select **Graphical template** and click **OK**.
4. Add new rows in the template.
 - a. Click **Insert --> Component --> Row** to add a new row.
 - b. Select a content type for the row and click **OK**.
 - c. Repeat steps a–b for each new row.
5. Add value fields to get the required data from your Tekla Structures database.
 - a. Click **Insert --> Value field**.
 - b. Click a point to define the location of the field within the row.

The **Select Attribute** dialog box appears prompting you to select an attribute for the value field.
 - c. Select an attribute and click **OK**.
 - d. Repeat steps a–c for each value field.
6. Add a header for each value field.
 - a. Click **Insert --> Component --> Header...**

- b. Click **Insert** --> **Text...**
 - c. Enter a heading for the template, and then click **OK**.
 - d. Click a point to define the location of the heading in the header row.
 - e. Repeat steps a–d to create headings for all the value fields.
7. Save the template:
- a. Click **File** --> **Save as**
 - b. Browse to the template folder defined for the advanced option `XS_TEMPLATE_DIRECTORY`.
 - c. In the **File name** field, enter a name for the template.
Include the extension `*.html.rpt` in the file name. For example, `Part_list.html.rpt`.
 - d. Click **OK**.

NOTE If you add images in your HTML template, the images should be located in `..\Program Files\Tekla Structures\<version>\bin\applications\Tekla\Tools\TplEd\bitmaps` folder, otherwise they are not shown in the HTML output.

Example

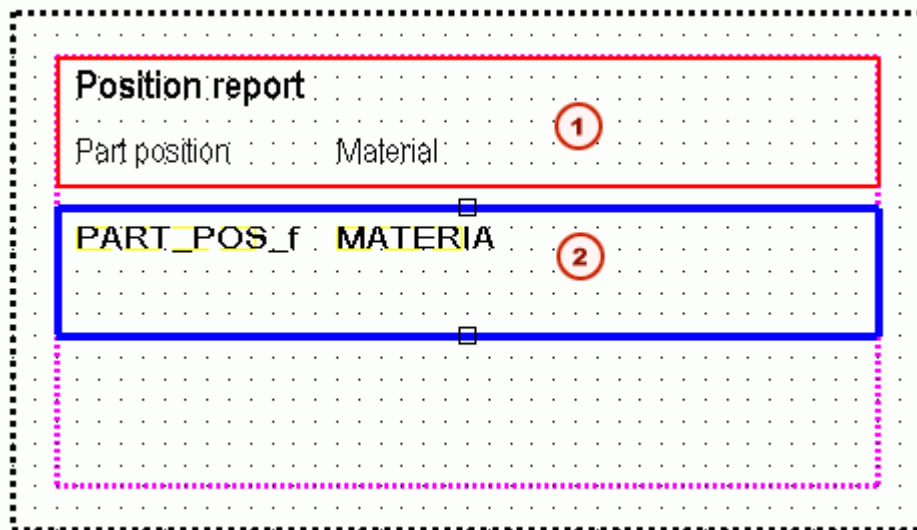

1. Header that contains text fields
2. Row that contains two value fields

See also

[Templates \(page 366\)](#)

[Add images in a template \(page 381\)](#)

7.4 Create a .pdf report template

You can create graphical templates to be used for .pdf reports.

1. On the **File** menu, select **Editors --> Template editor**.
2. Select **File --> New --> Graphical template**.
3. Click **Edit --> Properties**.
4. In **Template page properties** dialog box, set the page size to match the target page size (for example A4):

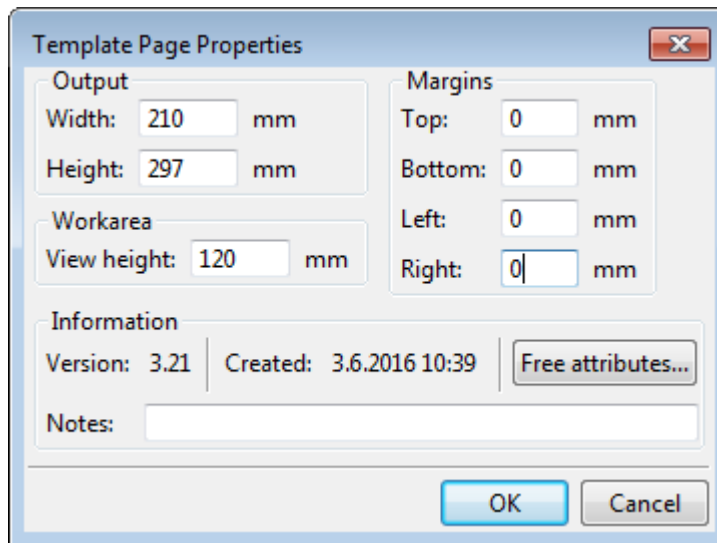

The size must match a size defined in the PaperSizesForDrawings.dat configuration file.

A0,	1189,	841
A1,	841,	594
A2,	594,	420
A3,	420,	297
A4,	297,	210
A5,	210,	148

5. Add new rows and value fields to get the required data from your Tekla Structures database. For more information about adding new rows and value fields, see [Create a template \(page 368\)](#).
6. Click **File --> Save as**, and save the report with the filename extension `.pdf.rpt`.
7. Copy the new template to your template folder, such as model or your company settings folder (XS_FIRM).

Now you can create a .pdf report using the new .pdf report template. For more information about creating a report, see [Create a report](#).

Example .pdf report

In this report example, the following page size is used:

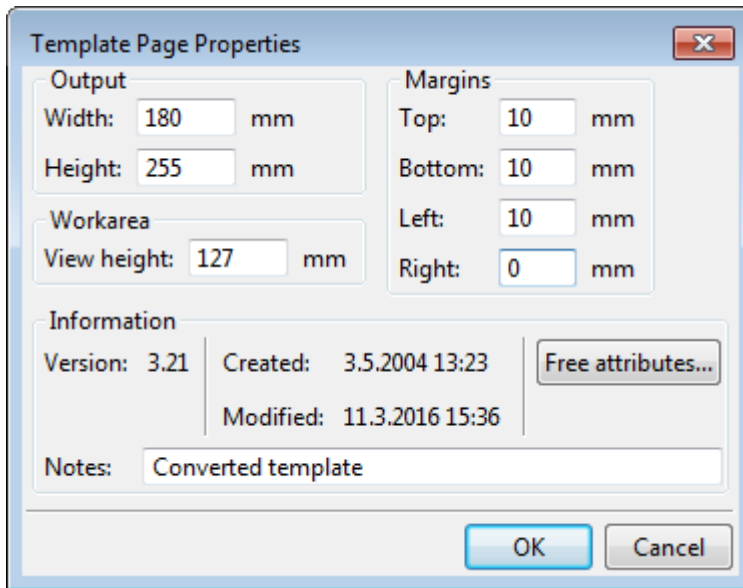

The screenshot shows a dialog box titled "Template Page Properties" with a close button (X) in the top right corner. The dialog is divided into several sections:













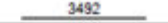

- Output:** Width: 180 mm, Height: 255 mm
- Workarea:** View height: 127 mm
- Margins:** Top: 10 mm, Bottom: 10 mm, Left: 10 mm, Right: 0 mm
- Information:** Version: 3.21, Created: 3.5.2004 13:23, Modified: 11.3.2016 15:36. A button labeled "Free attributes..." is located to the right of the "Created" field.
- Notes:** A text field containing "Converted template".

At the bottom of the dialog are two buttons: "OK" and "Cancel".

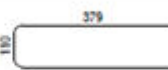
Below is an example of a report that has been created using this particular report template.

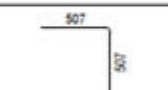
REBAR BENDING SCHEDULE

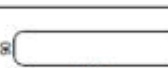
Project: **Rebar fabrication 1**

Pos	Diameter	Number	Grade	Length	Kg/p	Weight	Bending shape	Belongs to
WR/1	10	16	Undefined	800	0.49	7.9		W/4
WR/3	16	8	Undefined	7130	11.25	90.0		
WR/4	12	8	Undefined	3490	3.10	24.8		
WR/6	16	4	Undefined	7690	12.14	48.5		
WR/7	12	4	Undefined	4090	3.63	14.5		
WR/11	10	8	Undefined	950	0.59	4.7		W/3
WR/12	10	12	Undefined	2080	1.28	15.4		
WR/13	10	12	Undefined	2880	1.78	21.3		
WR/2	8	42	Undefined	830	0.33	13.8		W/3
WR/2	8	96	Undefined	830	0.33	31.5		W/4
WR/5	12	24	Undefined	980	0.87	20.9		
WR/8	6	14	Undefined	830	0.18	2.6		W/3
WR/9	6	22	Undefined	810	0.18	4.0		W/3
WR/10	8	78	Undefined	810	0.32	25.0		W/3
WR/10	8	184	Undefined	810	0.32	58.9		W/4
		Total:	532.0			Total:	383.7	

7.5 Create a template for nested assemblies

This example shows how to produce a template that displays the hierarchical structure of nested assemblies. You will create a nested assembly structure in a textual template similar to the one in the following picture:

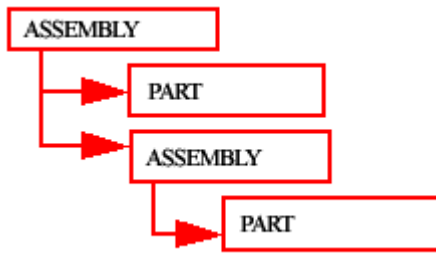

1. On the **File** menu, click **Editors --> Template Editor**.
2. In Template Editor, click **File > New**.
3. Select **Textual template** and click **OK**.
4. Add four new rows in the template.
 - a. Click **Insert --> Component --> Row** to add a new row.
 - b. Select a content type for the row, and then click **OK**.
For the first and third row, select the **ASSEMBLY** content type, and for the second and fourth row, select the **PART** content type.
 - c. Repeat steps a–b for each new row.
5. Use the arrow buttons under **Sorting and drawing order** to create a nested assembly structure for the template.
 - a. Move the second and third row down one level.
 - b. Move the fourth row down two levels.

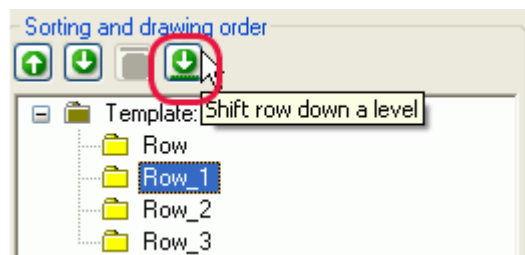

The structure should now look like this:

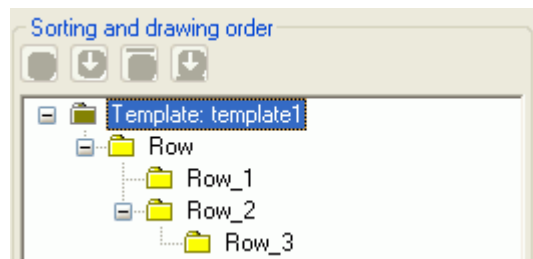

6. Add value fields to get the required data from your Tekla Structures database.

In this example, the added value fields are assembly or part position, number, and weight.

- a. Click **Insert --> Value field** .
 - b. Click a point to define the location of the field within the row.
The **Select Attribute** dialog box appears prompting you to select an attribute for the value field.
 - c. Select an attribute and click **OK**.
 - d. Repeat steps a–c for each value field.
7. Modify the layout of the template. For example:
 - a. Move objects to display the nested assembly structure in the printed report. To do this, select the object you want to move and drag it to the desired position.
 - b. Align objects. To do this, select all the objects you want to align, right-click and select the appropriate option from the pop-up menu, for example **Align --> Right** .
 - c. Add a header and a footer. To do this, click **Insert --> Component --> Page header** and **Page footer**. Add the required information to the header and footer.
 8. Save the template.

Example

Below is an example textual template and a report that has been created using the template:

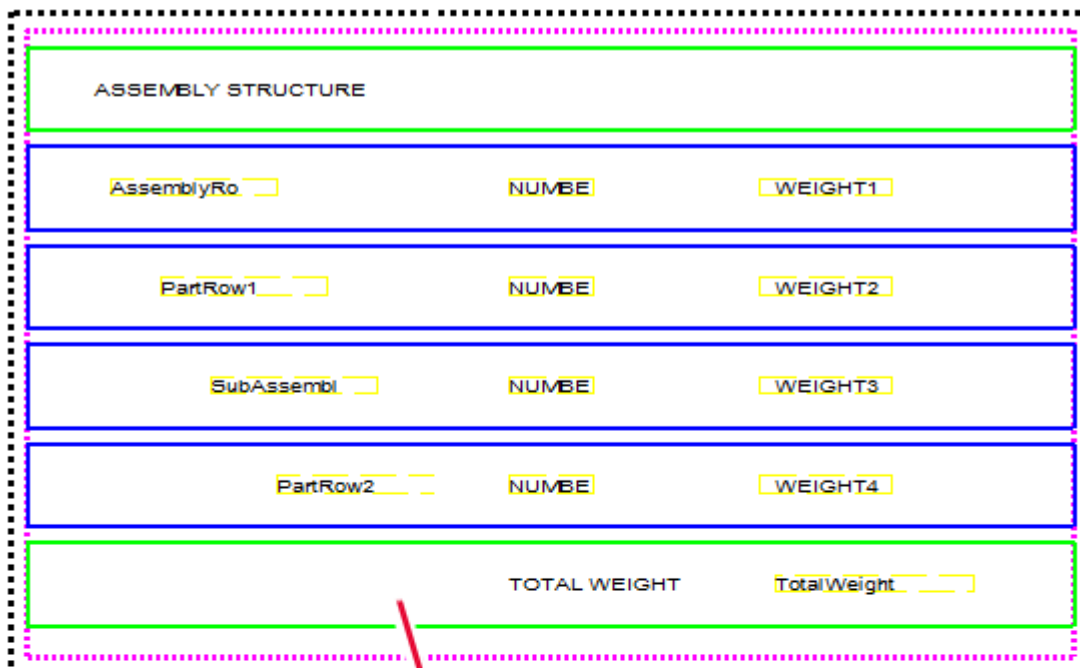

Assembly structure

TOP/1	1	677.5
SUBTRUSS/5	2	338.7
1001	2	3.6
1002	2	3.4
T/2	2	10.3
T/3	2	12.5
T/4	2	14.8
T/6	2	12.2
T/7	2	14.5
T/8	2	17.0
T/9	2	16.3
T/10	2	9.3
T/11	2	11.9
T/12	2	14.5
T/15	2	73.1
T/16	4	62.7
Total weight		677.5

NOTE You can create graphical templates for nested assemblies in the same manner as textual templates. The difference between graphical and textual templates is that in a graphical template you can display project and company information and graphics, such as table outlines, pictures, or symbols.

See also

[Templates \(page 366\)](#)

7.6 Create a template for bending schedules or pull-out pictures

You can use Template Editor for creating bending schedules or pull-outs pictures on reinforcement bars and bent meshes, and control the type of information that is shown in the bending schedules.







1. On the **File** menu, click **Editors --> Template Editor**.
2. Click **File --> New**.
3. Select **Graphical template** and click **OK**.
4. Click **Insert --> Component --> Row** to add a new row.
5. Select **REBAR** or **MESH** as the content type for the row.
6. Add value fields to get the required data from your Tekla Structures database.
 - a. Click **Insert --> Value field**.
 - b. Click a point to define the location of the field within the row.

The **Select Attribute** dialog box appears prompting you to select an attribute for the value field.
 - c. Select an attribute and click **OK**.
 - d. Repeat steps a–c for each value field.
7. Insert a graphical field to your **REBAR** or **MESH** content type row.
 - a. Click **Insert --> Graphical Field...**
 - b. Click and drag with the mouse to draw a frame.
8. Double-click the graphical field to open the **Graphical Field Properties** dialog box.
9. Click **Free attributes** and go to the **Application** tab.
10. Select the required bending diagram attributes.

You can also define the bending diagram attributes on the **User** tab. Note that if the same attribute is set both as **User** attribute and **Application** attribute, the **Application** attribute takes precedence.

For a list of attributes and values that can be used for bending schedules in templates, see [Bending schedule attributes \(page 380\)](#).
11. Save the template.

Example

Rebar list		Project number Project name		1 Trimble	Date: 04/05/2016		
Position	Size	Quantity	Grade	Length (mm)	Weight (kg)	Weight/Tot	Pull-out picture
1	12	1	A500HW	2310.0	2.1	2.1	
3	12	1	A500HW	1030.0	0.9	0.9	
4	12	1	A500HW	1150.0	1.0	1.0	
7	12	1	A500HW	2540.0	2.3	2.3	
8	12	1	A500HW	1570.0	1.4	1.4	
9	12	1	A500HW	1700.0	1.5	1.5	

Autoscaling pull-out pictures

There is a free attribute available for the PULLOUT attribute in graphical templates that you can use to define the scale type. If you set the free attribute `ScaleType` to 1 on the **User** tab in the **Free attributes** dialog box, the pull-out pictures will be scaled to fit the available space in both X and Y dimensions. As a result, the shape becomes out of proportion, but small segments can be seen more easily. Note that you can also set this attribute on the **Application** tab.

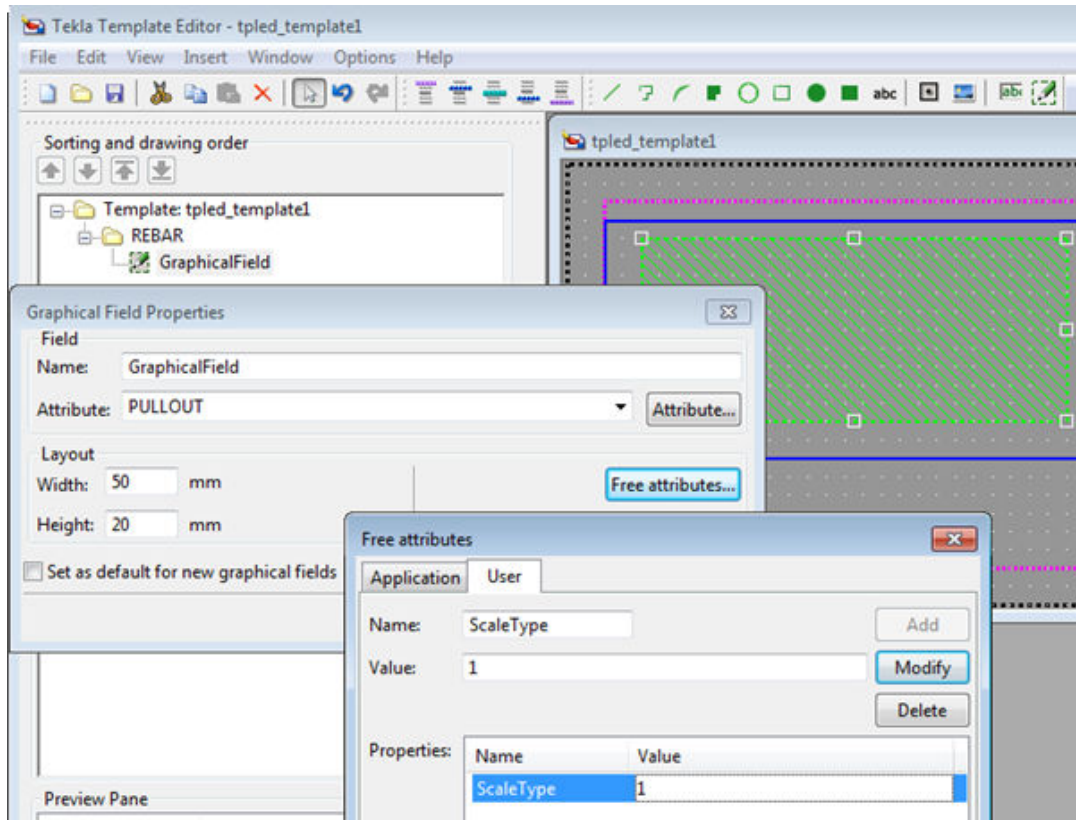

A bending shape may look like this if you do not define the free attribute `ScaleType`:

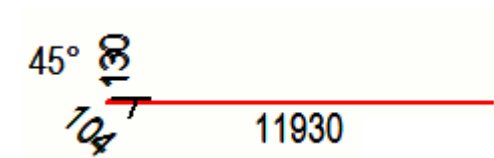

The same bending shape that uses the free attribute `ScaleType` with value 1.

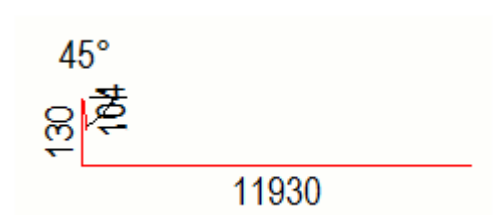

Change the appearance of the pull-out pictures

Tekla Structures uses the settings in the `rebar_config.inp` file in the system folder defined by the advanced option `XS_SYSTEM` to define the appearance of the pull-out pictures. You can change the colors, lines, and dimension unit, format, and precision used in pull-out pictures, for example. For a list of settings and values in `rebar_config.inp`, see Reinforcement settings for drawings (`rebar_config.inp`)

Bending schedule attributes

The following table lists the attributes and values that can be used for bending schedules in templates.

Attribute	Default value	Available values
FontName	romsim	Available template fonts
FontSize	2.0	Available font sizes
FontColor	1 (black)	1 = black 2 = red 3 = bright green 4 = blue 5 = cyan 6 = yellow 7 = magenta 8 = brown 9 = green 10 = dark blue 11 = forest green 12 = orange 13 = gray
RotationAxis	2	0 = by view 1 = by global Z 2 = by local axis
ScaleType	0	0 = no 1 = yes If you set the free attribute <code>ScaleType</code> to 1 for the <code>PULLOUT</code> attribute, the pull-out pictures will be scaled to fit the available space in both X and Y dimensions. As a result, the shape becomes out of proportion, but small

Attribute	Default value	Available values
		segments can be seen more easily.
Exaggeration	1	0 = no 1 = yes
EndMark	1	1 = straight 2 = half arrow 3 = full arrow
Dimensions	1	0 = no 1 = yes
BendingRadius	0	Shows the bending radius in form of diameter of the bending roll. 0 = no 1 = yes
BendingAngle	1	0 = no 1 = yes
ImageWidth	Width of the graphical field multiplied by 4.	Number of pixels
ImageHeight	Height of the graphical field multiplied by 4.	Number of pixels
CouplerSymbols	1	Display srebar coupler and end anchor symbols in rebar bending schedules. Rebar coupler symbols will be shown if CouplerSymbols property value is set to 1 and disabled if 0 is entered. The default value is 1.

See also

[Create a template for bending schedules or pull-out pictures \(page 377\)](#)

7.7 Add images in a template

You can add images in graphical templates. For example, you might want to include a company logo in your drawings. Tekla Structures supports the following image formats in graphical templates: .bmp, .jpg, .jpeg, .tif, .tiff and .png.

1. Open an existing graphical template or create a new graphical template in Template Editor.
2. Add a new row in the template:
 - a. Click **Insert** --> **Component** --> **Row** to add a new row.
 - b. Select a content type for the row and click **OK**.
3. Ensure that you have the row selected, and click **Insert** > **Picture** to open the **Select Picture File** dialog box.

If a local symbols folder exists, the contents of that folder are shown by default. You can browse for the contents of the `common\symbols` folder by selecting that folder. If a local symbols folder does not exist, Tekla Structures displays the contents of the `common\symbols` folder.

4. If you have images in other folders, you can display these folders in the **Select Picture File** dialog box:
 - a. In Template Editor, click **Options** --> **Preferences**.
 - b. Go to the **File Locations** tab and on the **Symbols, pictures** row, add a new folder separated by a semicolon (;), for example:

```
Symbols, pictures (*) | \..\..\common\symbols;\bitmaps;C:\TeklaStructuresTemplateImages\
```

The folder you defined is displayed in the **Directory** list:

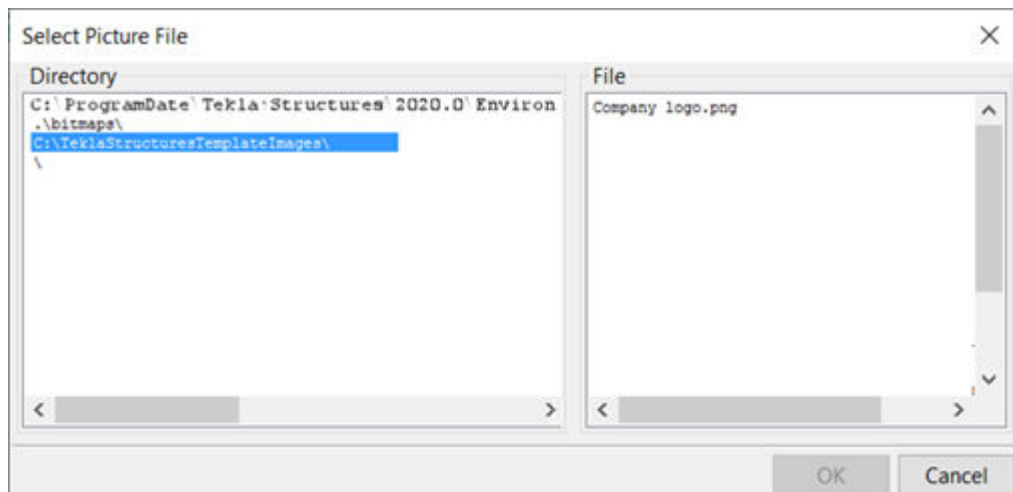

5. Select an image from the **File** list and click **OK** and add the image. You can adjust the size by dragging from the image handles.

Things to remember when adding images in templates

- Do not add very large images because they update very slowly.
- The image may look different in the image editor and in the printout or in the exported DWG file.
- When you export the drawing to DWG, Tekla Structures copies the images in the same folder as the DWG file. If the image for some reason is not in the same folder, only the name of the image is displayed together with an empty frame instead of the image in the DWG.
- If environments have local symbols, the local symbol folder is also included in the search path with the `common\symbols` folder. If the local symbols folder contains files with the same name as `common\symbols` folder, then the local symbol file is used.
- When you open the drawing that contains images inserted in the template, Tekla Structures first looks for the images in the model folder and then in the `\symbols` folder in the current environment.
- You can define a folder where Tekla Structures always looks for images using the advanced option `DXK_SYMBOLPATH`. You can also define a firm folder for your images.

Example

Below are some examples of the **Select Picture File** dialog box showing folder structure in different environments.

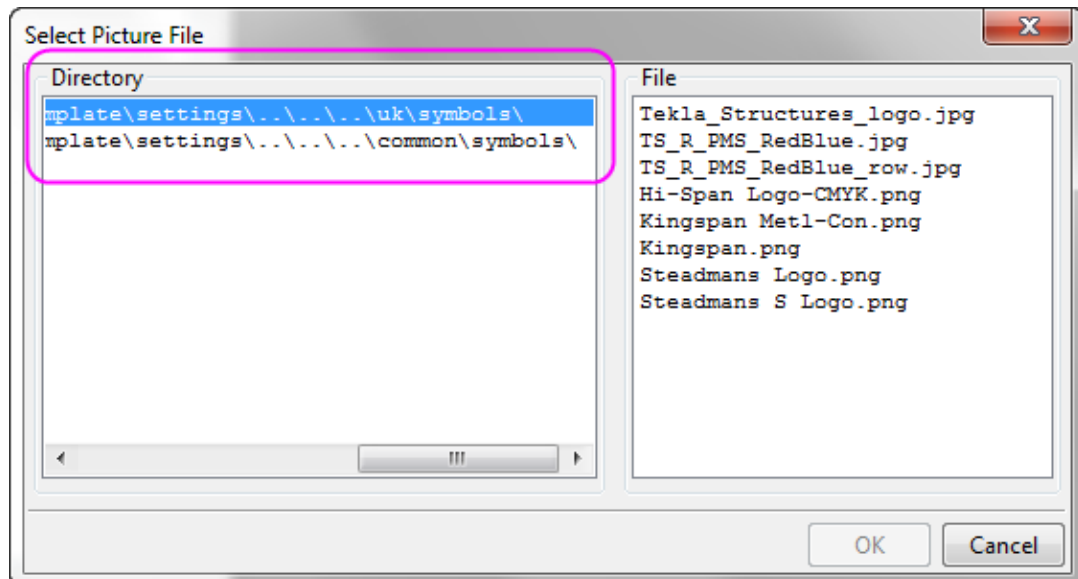

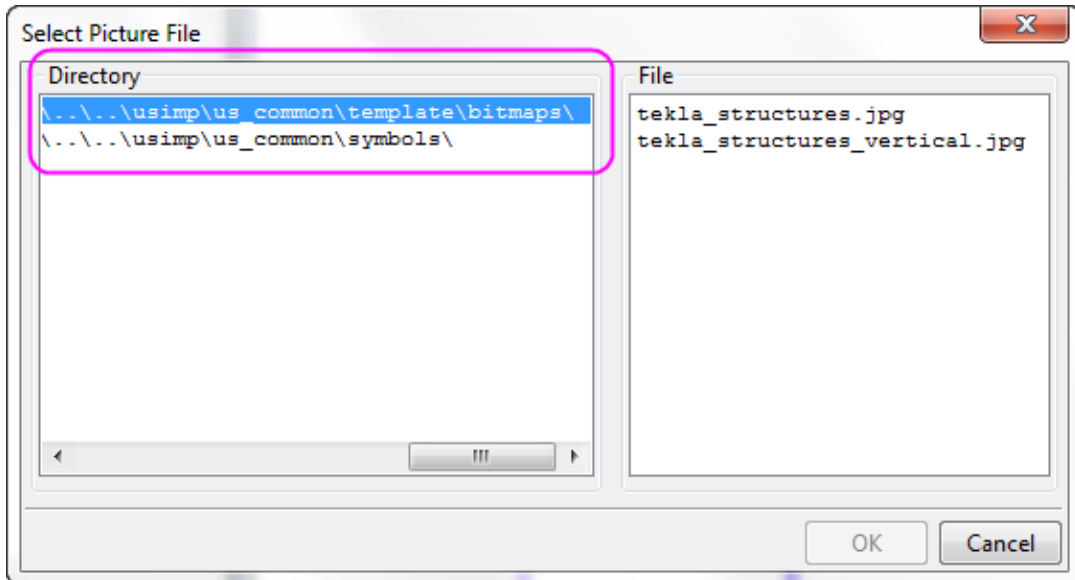

In the following example, a company logo has been added in a template.

No	REV MARK	REVISION DESCRIPTION	REV. DATE
			
DRAWING TITLE		GA-drawing	
CONTRACT		Corporation	
MODELLED BY		ISSUE DATE	
CONTRACT NO		1	SCALE 1:50
DRAWING No		[1]	REVISION No. 0

See also

[Templates \(page 366\)](#)

7.8 Content types

When you create a new row in the template, you must select a content type for the row. For example, when you add a row and then add a value field, Template Editor is asking for the content type. The content type determines which template attributes you can use on that row.

The available content types are:

Content type	Description
ANALYSIS_RIGID_LINK	Use to create lists of analysis rigid links.

Content type	Description
ANTIMATERIAL	<p>Use to create lists of holes and recesses, or parts removed as a result of a cut.</p> <p>In Template Editor, the same attributes that are available for PART are available for ANTIMATERIAL. However, only the attributes that are useful to be used with ANTIMATERIAL are shown, including NAME, LENGTH, WIDTH, HEIGHT, AREA, PROFILE, and NUMBER, and user-defined attributes.</p>
ASSEMBLY	<p>Use to create lists of assemblies and single parts. Includes all assemblies containing the selected parts and bolts.</p>
BOLT	<p>Use to create screw and bolt lists. Includes all bolts connected to selected parts.</p>
CAST_UNIT	<p>Use to create lists of cast units.</p>
CHAMFER	<p>Use to create lists of the length of the chamfers.</p>
COMMENT	<p>Use to create empty rows or rows that only have textual data or lines anywhere on a template.</p>
CONNECTION	<p>Use to create lists of connections.</p>
DRAWING	<p>Use to create drawing lists without revision history information. Use for reports and included drawings.</p>
HIERARCHIC_CAST_UNIT	<p>Use to create reports listing subassemblies of concrete.</p>
HIERARCHIC_OBJECT	<p>Use to create lists of various types of hierarchies. For example, lists hierarchical objects in Organizer.</p>
HISTORY	<p>Use to retrieve history information of the model. You can use this content type with PART, REBAR, CONNECTION and DRAWING rows.</p> <p>The following template attributes can be used with this content type:</p> <ul style="list-style-type: none"> • TYPE: the type of the historical action, for example update or numbering. • USER: the user who made the change. • TIME: the time the change was made. • COMMENT: the comment which was entered upon clicking Save. • REVISION_CODE: the revision code which was entered upon clicking Save.
HOLE	<p>Use to create lists of holes.</p>
LOAD	<p>Use to create lists of loads.</p>

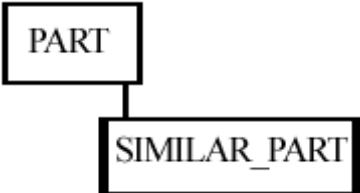
Content type	Description
LOADGROUP	Use to create lists of load groups.
MESH	Use to create lists of meshes.
NUT	Use to create lists of nuts. Contains all nuts for bolts associated with the selected parts.
PART	Use to create lists of parts.
POUR_BREAK	Use to create lists of pour breaks.
POUR_OBJECT	Use to create lists of pour objects.
POUR_UNIT	Use to create lists of pour units.
REBAR	Use to create lists of reinforcing bars.
REBAR_ASSEMBLY	Use to create lists of rebar assemblies.
REFERENCE_MODEL	Use to list the reference models.
REFERENCE_OBJECT	Use to list the reference model objects in a reference model. Only reference model objects that have user-defined attributes are displayed in reports.
REFERENCE_ASSEMBLY	Use to list the reference assemblies in a reference model.
REVISION	Use to create lists of revision marks.
SIMILAR_ASSEMBLY	Use to create lists of similar parts.
SIMILAR_CAST_UNIT	To use this content type, you need to have an empty (hidden in output) ASSEMBLY, PART or CAST_UNIT row in the row hierarchy above the row with SIMILAR_* content type:
SIMILAR_PART	
	 <p data-bbox="670 1514 1353 1581">You cannot have any rows below SIMILAR_* row content type in the row hierarchy.</p> <p data-bbox="670 1599 1369 1738">Note: Used in drawings to collect similar object information from the model. All the other attribute information is collected from visible drawing objects.</p>

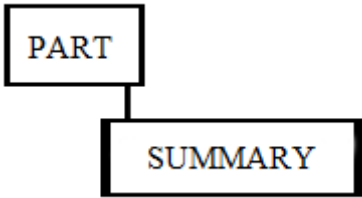
Content type	Description
SINGLE_REBAR	Use to create lists of individual bars in reinforcing bar groups. For example, use it to get the lengths of the individual bars in tapered reinforcing bar groups. For rebar sets, SINGLE_REBAR works in the same way as REBAR.
SINGLE_STRAND	Use to create lists of individual prestressed strands.
STRAND	Use to create lists of prestressed strands.
STUD	Use to create lists of studs.
SURFACE	Use to create lists of surfaces.
SURFACING	Use to create lists of surface treatments.
SUMMARY	Use to summarize the contents of the row(s) that are above SUMMARY in the hierarchy.  <pre> graph TD PART[PART] --- SUMMARY[SUMMARY] </pre> For example, use PART - SUMMARY hierarchy to summarize the contents of the PART rows.
TASK	Use to create lists of tasks.
WASHER	Use to create lists of washers. Contains all washers for all bolts associated with the selected parts.
WELD	Use to create lists of welds.

See also

[Template attribute files \(contentattributes.lst\) \(page 387\)](#)

7.9 Template attribute files (contentattributes.lst)

Template attributes represent object properties. You can use template attributes in value fields, formulas, and row rules to get the required data from your Tekla Structures database.

When you output the template, Tekla Structures replaces the attribute with the actual value of the corresponding object property. For example, if you

include the attribute `WEIGHT` in a report template, Tekla Structures displays the weight of the model object in the report.

Template attributes are defined in the following files:

File name	Description
contentattributes.lst	<p>This is a container file listing all the files that contain the actual attribute definitions. The files are added with <code>INCLUDE</code> sentences. The order of the files included in <code>contentattributes.lst</code> defines the reading order of the files.</p> <p>This file is overwritten in the installation when you install a newer version of Tekla Structures. Ensure that you make a copy of this file before updating.</p> <p>Generally, there is no need to modify <code>contentattributes.lst</code>. Do not modify it if you are not an administrator.</p>
contentattributes_global.lst	<p>This file contains attributes that are hard-coded into the program. Do not edit this file.</p>
contentattributes_userdefined.lst	<p>This file contains user-defined attributes, the same as in the <code>objects.inp</code> file.</p> <p>This file is overwritten in the installation when you install a newer version of Tekla Structures. To use your own attributes in templates and reports, create a copy of this file and add the necessary attributes to that file.</p>

By default, these files are located in `..\Program Files\Tekla Structures\<version>\bin\applications\Tekla\Tools\TplEd\settings`, but the location may be different in your environment.

The search order for the `contentattributes.lst` file is defined in the `tplled.ini` file. The location of the `tplled.ini` file is defined by the [XS_TPLED_INI](#) advanced option.

The following pointers are allowed in the `tplled.ini` file:

- `@\` = location of the `tplled.ini` file

- .\ = location of `tpld.exe` (C:\Program Files\Tekla Structures\
\`<version>`\bin\applications\Tekla\Tools\TplEd)

To include your own attributes, modify the `contentattributes.lst` files in the relevant environment folders. Note that the `contentattributes.lst` files are overwritten when you install a new version of Tekla Structures.

See also

[User-defined template attributes \(page 389\)](#)

[Location of certain hidden files and folders \(page 364\)](#)

7.10 User-defined template attributes

User-defined template attributes are defined in the `contentattributes_userdefined.lst` file. By default, this file includes most of the user-defined attributes that are visible in the part properties. To use your own attributes in templates and reports, you should make a copy of the file, rename it appropriately, and add the necessary attributes to that file.

The `contentattributes_userdefined.lst` file is divided into two sections:

- A list of attribute names and default settings:

```

..
// Name                               Datatype   Justify   Cacheable  Length
// XXXXX                               FLOAT      RIGHT    TRUE       8
// -----
axial1                                 FLOAT      RIGHT    TRUE       8
axial2                                 FLOAT      RIGHT    TRUE       8
BOLT_COMMENT                           CHARACTER  LEFT     TRUE       64
BOLT_USERFIELD_1                       CHARACTER  LEFT     TRUE       64
BOLT_USERFIELD_2                       CHARACTER  LEFT     TRUE       64
BOLT_USERFIELD_3                       CHARACTER  LEFT     TRUE       64
BOLT_USERFIELD_4                       CHARACTER  LEFT     TRUE       64
BOLT_USERFIELD_5                       CHARACTER  LEFT     TRUE       64
BOLT_USERFIELD_6                       CHARACTER  LEFT     TRUE       64
BOLT_USERFIELD_7                       CHARACTER  LEFT     TRUE       64
BOLT_USERFIELD_8                       CHARACTER  LEFT     TRUE       64
cambering                               CHARACTER  LEFT     TRUE       64
CHECKED_BY                              CHARACTER  LEFT     TRUE       20
CHECKED_DATE                            CHARACTER  LEFT     TRUE       20
comment                                 CHARACTER  LEFT     TRUE       30
CONN_CODE_END1                          CHARACTER  LEFT     TRUE       10
CONN_CODE_END2                          CHARACTER  LEFT     TRUE       10
DRAWING_USERFIELD_1                    CHARACTER  LEFT     TRUE       64
DRAWING_USERFIELD_2                    CHARACTER  LEFT     TRUE       64
DRAWING_USERFIELD_3                    CHARACTER  LEFT     TRUE       64
DRAWING_USERFIELD_4                    CHARACTER  LEFT     TRUE       64

```

- A list of attributes assigned to content types:

①	PART	=	②	ASSEMBLY.MAINPART.USERDEFINED.	③	[Parameters]	④	comment
	PART	=	ASSEMBLY.MAINPART.USERDEFINED.	[Parameters]	xs_shorten			
	PART	=	ASSEMBLY.MAINPART.USERDEFINED.	[Parameters]	cambering			
	PART	=	ASSEMBLY.MAINPART.USERDEFINED.	[Parameters]	PRELIM_MARK			
	PART	=	ASSEMBLY.MAINPART.USERDEFINED.	[Parameters]	OBJECT_LOCKED			
	PART	=	ASSEMBLY.MAINPART.USERDEFINED.	[Parameters]	fabricator			
	PART	=	ASSEMBLY.MAINPART.USERDEFINED.	[Parameters]	USER_FIELD_1			
	PART	=	ASSEMBLY.MAINPART.USERDEFINED.	[Parameters]	USER_FIELD_2			
	PART	=	ASSEMBLY.MAINPART.USERDEFINED.	[Parameters]	USER_FIELD_3			
	PART	=	ASSEMBLY.MAINPART.USERDEFINED.	[Parameters]	USER_FIELD_4			
	PART	=	ASSEMBLY.MAINPART.USERDEFINED.	[Parameters]	USER_PHASE			

1. The content type of the row in Template Editor
2. The attribute hierarchy in Template Editor
3. Customizable comments, such as the tab name in the user-defined attributes dialog box
4. The name of the user-defined attribute, must be the same as in the `objects.inp` file

See also

[Add user-defined template attributes to Template Editor \(page 390\)](#)

[Add comments to user-defined template attributes \(page 392\)](#)

[Add hierarchy to user-defined template attributes \(page 392\)](#)

Add user-defined template attributes to Template Editor

This example shows how to add your own user-defined attributes to the attribute tree in Template Editor.

Before you start, add your user-defined attribute to the `objects.inp` file. For example, you might add an attribute named `MY_ATTRIBUTE` to the user-defined properties of drawings.

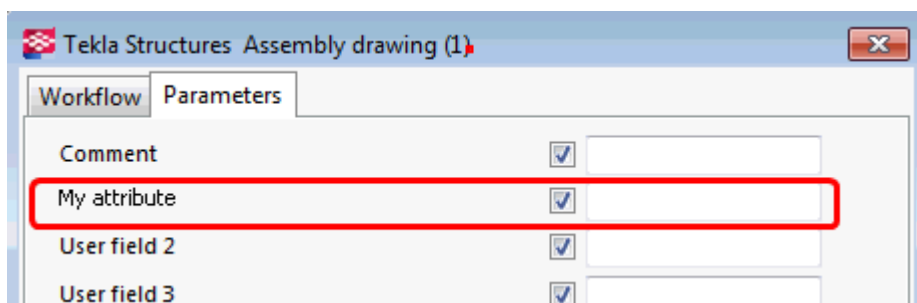

1. Open the `contentattributes_userdefined.lst` file in a text editor.

2. Save the file with an appropriate name, for example `MY_contentattributes_userdefined.lst`, in the same folder.
3. Add `MY_ATTRIBUTE` to the list of attribute names and, define the settings as follows:

MORTAR_WIDTH	FLOAT	RIGHT	TRUE
MY_ATTRIBUTE	CHARACTER	LEFT	TRUE
OBJECT_LOCKED	CHARACTER	LEFT	TRUE

4. Add `MY_ATTRIBUTE` to the list of attributes assigned to content types.
Select the content type according to which object the attribute is associated to in the `objects.inp` file. In this example, the content type is `DRAWING`. Add the attribute in the format `USERDEFINED.<ATTRIBUTE_NAME>`.

```
// =====
//   Drawing attributes
//   -----
//   tab_page("DR_Parameters")
//   =====
DRAWING = USERDEFINED.MY_ATTRIBUTE
```

5. Save the changes.
6. Open the `contentattributes.lst` file.
7. Add the following line in the file:
`[INCLUDE MY_contentattributes_userdefined.lst]`
8. Save the changes.

The attribute is shown in the attribute tree in Template Editor, under `DRAWING > USERDEFINED`:

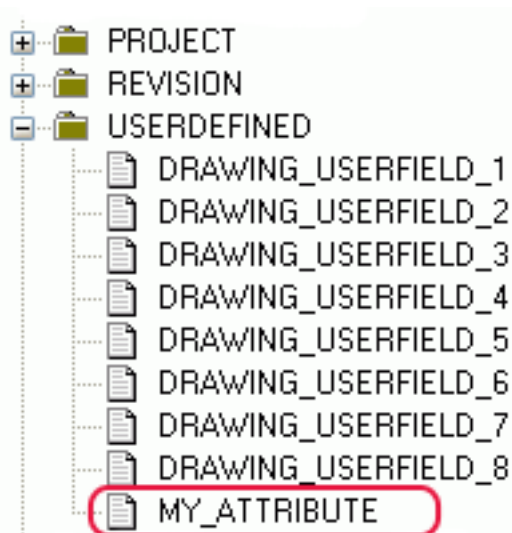

See also

[User-defined template attributes \(page 389\)](#)

Add comments to user-defined template attributes

You can add your own comments to the user-defined attributes in the Template Editor attribute tree.

1. Open your copy of the `contentattributes_userdefined.lst` file.
For example, `MY_contentattributes_userdefined.lst`. Do not modify the original `contentattributes_userdefined.lst` file.
2. Scroll down to the list of attributes assigned to content types.
3. Add your comment inside quotation marks, after the attribute name.
For example:

```
DRAWING      = USER-DEFINED.MY_ATTRIBUTE "my comment"
```

4. Save the changes.

The comment you added is displayed in the attribute tree in Template Editor:

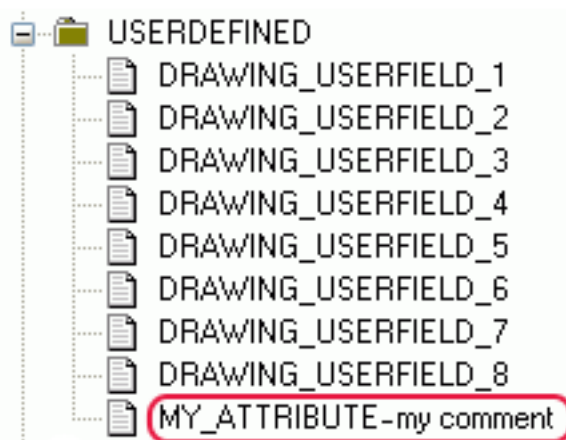

See also

[User-defined template attributes \(page 389\)](#)

Add hierarchy to user-defined template attributes

You can add your own hierarchy to the Template Editor attribute tree.

1. Open your copy of the `contentattributes_userdefined.lst` file.
For example, `MY_contentattributes_userdefined.lst`. Do not modify the original `contentattributes_userdefined.lst` file.
2. Scroll down to the list of attributes assigned to content types.
3. Define the hierarchy in square brackets, between `USERDEFINED.` and the attribute name.

For example:

```
DRAWING = USERDEFINED.[Folder 1.Folder 2].MY_ATTRIBUTE "my comment"
```

NOTE Notice the periods after the brackets, and between the hierarchies.

4. Save the changes.

The new hierarchy is shown in the attribute tree:

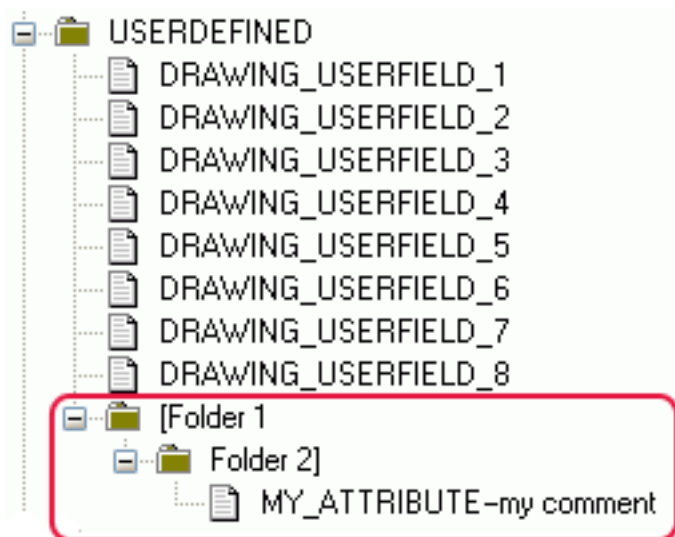

WARNING User-defined attributes are case sensitive. Ensure that you enter the attribute name using the correct case for all characters.

See also

[User-defined template attributes \(page 389\)](#)

7.11 Tips for templates

There are some things that you might consider to be able to use templates more efficiently.

Click the links below to find out more:

- [Use text type attribute in calculations \(page 394\)](#)
- [Change value field content to use imperial units \(page 394\)](#)
- [Define customized date format \(page 395\)](#)
- [Assembly or cast unit drawing sheet number \(page 395\)](#)
- [Use format functions in value fields \(page 396\)](#)

Use text type attribute in calculations

Change text to numeric format

```
double (GetValue ("ASSEMBLY_TOP_LEVEL"))
```

Change into correct format for calculation (double=decimals)

```
format (double (GetValue ("ASSEMBLY_TOP_LEVEL")), "Length", "mm", 1)
```

Add all above into calculation formula

```
format (double (GetValue ("ASSEMBLY_TOP_LEVEL")), "Length", "mm", 1)+15000
```

Another example of the same for part elevation

```
(double (GetValue ("TOP_LEVEL")) -  
(double (GetValue ("BOTTOM_LEVEL")))) *1000
```

Change value field content to use imperial units

Advanced option to check if imperial units are in use:

```
GetValue ("ADVANCED_OPTION.XS_IMPERIAL")==TRUE
```

Translated string call for multi lingual text:

```
GetValue ("TranslatedText ("albl_Diameter_"))
```

Formatting of units:

```
format (GetValue ("DIAMETER"), "Length", "inch-frac", 1/16)
```

```
format (GetValue ("DIAMETER"), "Length", "mm", 1)
```

Combine all above in a rule:

```

if GetValue("ADVANCED_OPTION.XS_IMPERIAL")==TRUE then
GetValue("TranslatedText("albl_Diameter_")")+
format(GetValue("DIAMETER"),"Length","inch-frac", 1/16) + "
Inches"
else
GetValue("TranslatedText("albl_Diameter_")")+
format(GetValue("DIAMETER"),"Length","mm", 1)+" mm"
endif

```

Define customized date format

Use mid function to find year, month and day:

```
mid("", "", "") string, offset, n
```

year:

```
mid(format(GetValue("DATE"),"Date","dd.mm.yyyy", ), "6", "4")
```

month:

```
mid(format(GetValue("DATE"),"Date","dd.mm.yyyy", ), "3", "2")
```

days:

```
mid(format(GetValue("DATE"),"Date","dd.mm.yyyy", ), "0", "2")
```

Combine all above in rule:

```
mid(format(GetValue("DATE"),"Date","dd.mm.yyyy", ), "6", "4")
+"-"+
```

```
mid(format(GetValue("DATE"),"Date","dd.mm.yyyy", ), "3", "2")
+"-"+
```

```
mid(format(GetValue("DATE"),"Date","dd.mm.yyyy", ), "0", "2")
```

Assembly or cast unit drawing sheet number

Use match function to find "-" character

```
match(GetValue("NAME_BASE"), "*-*")
```

Use of mid function to return only characters after "-"

```
mid(GetValue("NAME_BASE"), (1+
(find(GetValue("NAME_BASE"), "-"))), 2)
```

Combine all above in rule

```
if (match(GetValue("NAME_BASE"), "*-*"))
```

```

then mid(GetValue("NAME_BASE"), (1+
(find(GetValue("NAME_BASE"), "-"))), 2)

else ""
endif

```

Use format functions in value fields

You can define the format used in a value field in two ways: In the **Value Field Properties** dialog box by filling in the fields for **Datatype**, **Meaning**, **Unit** and **Decimals**, or by creating a formula in the **Formula** field. In formulas, you can use the format function that converts an attribute value to a formatted information string.

When you use a format function in a formula, always set the **Datatype** to **Text** in the **Value Field Properties** dialog box. Leave the other fields in the **Format** area empty.

For example, if you want to convert the attribute value to numbers with decimals in the report, you need to include the conversion function `double` in the format function:

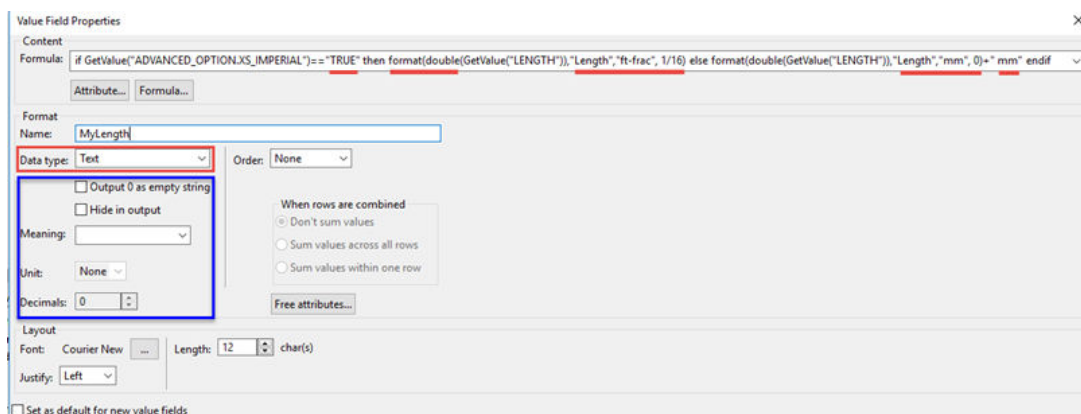

The default values for unit and decimals are defined in the `contentattributes_global.lst` file. The format function converts the attribute value to a formatted information string on the basis of what you have defined in the format function. The format function overrides the definitions in the `contentattributes_global.lst` file and settings that you have defined in the **Format** area of **Value Field Properties** dialog box.

Example of the result in a report when you use the formula above:

Mesh Information:

Geometry Size: 4/4-150/150-2750*2000

Length: 9'-1/4"

Height: 6'-6 3/4"

Example of the result of the formula, when you use set the advanced option XS_IMPERIAL to FALSE instead of TRUE:

Mesh Information:

Geometry Size: 4/4-150/150-2750*2000

Length: 2750 mm

Height: 2000 mm

For a list of valid unit and precision strings, see the `valuefieldclasses.lst` file located in the `..\Program Files\Tekla Structures\<version>\bin\applications\Tekla\Tools\TplEd\settings` folder. Do not make changes in this file. Below is an example of the file content, which may change between Tekla Structures versions.

```
//
-----
//
// - Use only letters, numbers, slashes and underlines.
//
//
-----
//
// Class          =          units { presicions }

Length           =          mm, dm, cm, m, inch, ft, yd, inch-frac
{1/2, 1/4, 1/8, 1/16 }, ft-frac { 1/2, 1/4, 1/8, 1/16 }
Angle            =          Degrees, radians
Area             =          mm2, cm2, dm2, m2, sq.inch, sq.ft, sq.yd
Area/length     =          mm2/m, cm2/m, dm2/m, m2/m, in2/in,
in2/ft, ft2/ft, sq.yd/ft
Volume          =          mm3, cm3, dm3, m3, cu.in, cu.ft, cu.yd
Weight          =          kg, T, N, lbf, kip
Weight/length   =          kg/m, T/m, N/m, daN/m, kN/m, lbf/ft
Density         =          kg/m3, T/m3, N/m3, kN/m3, lbf/ft3
Temperature     =          Kelvin, Celsius, Fahrenheit
Section_modulus =          mm3, cm3, in3
Moment_of_inertia =          mm4, cm4, in4
Warping_modulus =          mm6, cm6, in6
Force           =          kg, T, N, daN, kN, lbf, kip
Force/length    =          kg/m, T/m, N/m, daN/m, kN/m, lbf/in,
lbf/ft, kip/in, kip/ft
Force/area      =          kg/m, kg/cm, kg/mm, T/m, T/cm, T/mm, N/m,
N/cm, N/mm, daN/m, daN/cm, daN/mm, kN/m, kN/cm, kN/mm, lbf/in, lbf/ft,
kip/in, kip/ft
Moment          =          kgm, Tm, Nm, daNm, kNm, lbf-in, lbf-ft,
kip-in, kip-ft
Moment/length   =          kgm/m, Tm/m, Nm/m, daNm/m, kNm/m, lbf-
ft/ft, kip-ft/ft
Stress          =          kg/m2, kg/cm2, kg/mm2, T/m2, T/cm2, T/
mm2, N/m2, N/cm2, N/mm2, daN/m2, daN/cm2, daN/mm2, kN/m2, kN/cm2, kN/mm2,
psi, psf, ksi, ksf
Date            =          dd.mm.yyyy, mm.dd.yyyy, mm/dd/yyyy,
yyyy/mm/dd, dd-mm-yy, dd-mm-yy, yyyy-mm-dd, dd/mm/yy
Time           =          hh:mm:ss, hh:mm:ss:am/pm
Date&&Time      =          dd.mm.yyyy, mm.dd.yyyy, mm/dd/yyyy,
yyyy/mm/dd, dd-mm-yy, dd-mm-yyyy, yyyy-mm-dd, dd/mm/yy
Date_local     =          dd.mm.yyyy, mm.dd.yyyy, mm/dd/yyyy,
yyyy/mm/dd, dd-mm-yy, dd-mm-yyyy, yyyy-mm-dd, dd/mm/yy
Time_local     =          hh:mm:ss, hh:mm:ss:am/pm
```

```
Date&&Time_local      =      dd.mm.yyyy, mm.dd.yyyy, mm/dd/yyyy,  
yyyy/mm/dd, dd-mm-yy, dd-mm-yyyy, yyyy-mm-dd, dd/mm/yyLeadingZeroes  
LeadingZeroes  
DistanceList         =      mm, dm, cm, m, inch, ft, yd, inch-frac  
{1/2, 1/4, 1/8, 1/16 }, ft-frac { 1/2, 1/4, 1/8, 1/16 }
```

For more information about value fields, formats, format functions and other functions, see [Template Editor User's Guide](#).

8

Tekla Model Sharing and multi-user for administrators

You can find a table of the differences between Tekla Model Sharing and multi-user models [here](#).

8.1 Tekla Model Sharing

Tekla Model Sharing enables efficient global collaborative modeling within a shared Tekla Structures model. Tekla Model Sharing gives users the freedom to work with the same model at the same time in different locations and time zones.

In Tekla Model Sharing each user has a local version of the model on their computer, or on a network drive, and the model data is shared and synchronized over the Internet using a Microsoft Azure cloud sharing service. When a model is shared, it is connected to the cloud-based sharing service. You can check the status of the service at any time.

NOTE The users of the same shared model need to have the same Tekla Structures version, and use the same latest service pack.

When a user starts to share a model, the organization the user belongs to gets the [model ownership](#). In Tekla Model Sharing, an organization always owns all the models shared by the users in the organization. A shared model is always owned by only one organization. You can manage and view all the shared models owned by your organization with the web-based [Management Console for Tekla Model Sharing](#). Logging in requires Trimble Identity administrator rights.

Tekla Model Sharing requires a valid Tekla Model Sharing license and a Trimble Identity which is part of a valid organization. Based on the Trimble Identity information, you can assign and manage Tekla Model Sharing licenses in the web-based [Tekla Online Admin Tool](#). For more information, see [Managing Trimble Identities and Tekla Model Sharing licenses](#).

Tekla Model Sharing cloud sharing service status is publicly available at [Tekla Model Sharing Status](#). On this web-site, you can also find information about any service breaks.

For more information on how Tekla Model Sharing works, see

- [What is Tekla Model Sharing](#)
- [Work with Tekla Model Sharing](#)
- [What is shared in Tekla Model Sharing](#)
- [Best practices in Tekla Model Sharing](#)
- [Manage models in Management Console for Tekla Model Sharing](#)

NOTE Tekla Model Sharing requires a single-user model. A model cannot be simultaneously shared and used in the multi-user mode. If you want to start using multi-user mode to share your model instead of Tekla Model Sharing, you first need to exclude your local version of the model from the sharing service and then convert it to a multi-user model.

The excluded model has no connection to the original shared model in the sharing service. This means that if you exclude your local version of the model from the sharing service and start to use the model in multi-user mode, you cannot later merge the original shared model and the multi-user model.

8.2 Multi-user models

You can work on Tekla Structures models in either single-user or multi-user mode. Multi-user mode allows several users to access the same model at the same time. Several users can work on the same project and be aware of the others' progress, so that copying and merging models is not needed.

The multi-user model consists of a single master model that can be located anywhere in the network. Each user can access this model, and open their own local view of the model on a client computer. This local view is called a working model. Any changes that a user makes to the working model are local, and not visible to other users, until the working model is saved to the master model.

The multi-user model is locked during opening, saving, and numbering. When one of the users performs any of these operations, other users cannot perform them during that time. For more information, see [How multi-user works](#).

NOTE All users of the multi-user model should use the same settings and the same version and service pack of Tekla Structures.

Tekla Structures multi-user server runs as a service that is started automatically when you start the computer. You do not need to log in to the service. We recommend that you use the latest multi-user server version

available regardless of the Tekla Structures version that you use. Note that using the multi-user server requires your company to have more than one Tekla Structures license.

Setting access rights to a multi-user model

You can protect user-defined attributes using privileges. You can also prevent your model and drawings from being accidentally modified by using the **Locked** user-defined attribute (UDA). You can use the UDA for parts (separately for beams, columns, and so on), bolts, welds, specific drawing types, project properties, and phase properties.

Using the **Locked** UDA and privileges together you can even restrict some users or organizations from modifying your model. For more information on access rights, see Access rights in multi-user mode.

The **Locked** UDA has three values: **Yes**, **No**, and **Organization**. When set to **Yes**, the object is locked and you cannot modify its properties. You can only change the object's user-defined attributes that do not affect numbering. If you try to modify a locked object, Tekla Structures displays the following warning message:

```
There are locked objects, see report. The operation could not be performed.
```

To add the lock attribute to the user interface, you need to add the following line in the object's section in the `objects.inp` file:

```
attribute("OBJECT_LOCKED", attribute("OBJECT_LOCKED",  
"Locked:", option,"%s", none, none, "0.0", "0.0")  
{  
value("No", 1)  
value("Yes", 0)  
value("Organization", 0)  
})
```

9 Import Tekla Structures model and drawings into another model

You can use the **Import model** command to import a Tekla Structures model and drawings to another model. If the imported model is later updated, you can re-import the updated model.

- It is not possible to import a model or parts of it directly into the same model (for example, if the model folder has been copied in the file system and then worked on separately). You can work around this, for example, by first importing the model into a new empty model or by using the **Save as** command to create a copy of the model.
 - If you import to an existing model, fix the possible numbering conflicts by adding prefixes in numbering series.
 - Importing models from older versions of Tekla Structures is not allowed. When you try to import an old model, the following message is displayed: "Importing models from previous versions is not supported. First save the model with the current version. Note that you will not be able to use Tekla Structures of previous version to edit the model." Click **Open for upgrade** to open and save the model in the new version, or click **OK**.
 - You can use the **Import model** command as a replacement to the old model dump import. Import the model to an empty Tekla Structures model created without a model template.
1. Open the Tekla Structures model into which you want to import the other model.
 2. Go to **Quick Launch**, start typing `import model`, and select the **Import model** command from the list that appears.

3. Select a model folder to import and click **OK**.

The model objects and drawings are imported and the changes are displayed using the same listing as is used in Tekla Model Sharing.

With default settings, the **Locked** attribute is set to **Yes** in the imported objects. Locking is controlled by the advanced option

`XS_MODEL_IMPORT_LOCK_OBJECTS` in the **Import** category of the **Advanced Options** dialog box.

10 Import user-defined attribute values

You can import user-defined attribute (UDA) values to a model from a text file. For example, you can import a list of manufactured or checked assemblies. You can also clear existing user-defined attribute values through attribute import.

You can import attribute values to Tekla Structures model objects, drawings, and reference model objects (if configured, see Add UDAs in reference models). You define matching criteria for the attribute import in your input file, and you can additionally limit the import scope to objects you select in the model or to reference model objects.

The input file can be:

- Exported from other software.
- Created manually using any standard text editor, for example, Microsoft Notepad.
- Created from Microsoft Excel by saving the file with the **Save as** command to **Text (Tab-delimited) (*.txt)** format.
- A simple Tekla Structures report containing the part GUIDs and user-defined attributes.

NOTE There are alternative ways to import data into user-defined attributes. For example, user-defined attributes can be filled in when you import IFC objects and convert them to native Tekla Structures objects. There are also several extensions in [Tekla Warehouse](#) that allow you to modify user-defined attribute data.

10.1 Input file structure

You can import user-defined attribute (UDA) values into Tekla Structures models from input files, which are delimited text files.

Delimiters

A delimiter is a character that separates different fields that are on the same line. You can delimit fields with any ASCII character that does not appear in the names or values of the attributes that you are importing. You can use several alternative delimiters in the same input file. Common delimiter characters include the comma, tab, semicolon, and space.

Field and value definitions

In the input file, the first line is a header that defines the fields for the rest of the input file. All other lines in the input file contain the values for the fields that you named on the first line.

The first line must contain at least one *key field* that identifies the model objects or drawings, and at least one user-defined attribute name that identifies a user-defined attribute field into which you want to import new values. Note that the names of many of the fields are different than the field labels that you see in the user interface. The user-defined attribute names are defined [in the objects.inp files \(page 306\)](#) that apply to the model ([see the reference on how to read the file \(page 303\)](#)).

The configuration file `import_macro_data_types.dat` (which is explained further ahead) defines which fields you can use in the attribute import and what is each attribute's data type. It is not possible to add or change the key fields, but you can edit the set of user-defined attributes. Values are imported as strings (text) unless a different data type is defined for the attribute in the `import_macro_data_types.dat` file.

Available key fields

The key fields for model objects are:

Key field	Example	Action
GUID	ID4FEAFC88-0000-0004-3133-343038303031	Tekla Structures assigns the user-defined attributes on this line in the input file to the model object that has a GUID value of ID4FEAFC88-0000-0004-3133-343038303031.
ASSEMBLY_POS or MARK	A3	Tekla Structures assigns the user-defined attributes on this line in the input file to the assembly that has an ASSEMBLY_POS value of A3. Repeat this line for each assembly you want to include.
PHASE	2	Tekla Structures assigns the user-defined attributes on this line in the input file to the assembly that has a PHASE value of 2. You must also use ASSEMBLY_POS as a key field with this option.

The key fields for drawing objects are:

Key field	Example	Action
TYPE NAME	A D4	Tekla Structures assigns the user-defined attributes on this line in the input file to the drawing that has a <code>TYPE</code> value of A and a <code>MARK</code> value of D4. Use both key fields in the input file.
ID	134	Tekla Structures assigns the user-defined attributes in this line in the input file to the drawing object that has an <code>ID</code> value of 134.

Empty values

It is possible that some lines in the input file do not have a value for all of the attribute fields (there may be two or more consecutive delimiter characters between values). These empty values can be either skipped during import without making any changes to user-defined attributes, or you can use these empty values to erase existing user-defined attribute values in your model. By default, empty values are skipped. To clear existing values instead, set the advanced option `XS_ERASE_UDA_VALUE_WITH_ATTRIBUTE_IMPORT_NULL_AND_BLANK` to `TRUE` in an ini file.

Read-in order

Tekla Structures reads the input file in order starting from the first line. If there are duplicate key fields on the following lines, only the first occurrence is imported.

10.2 Data file (`import_macro_data_types.dat`)

To import a value into a user-defined attribute, the field name and data type must be correctly defined in the `import_macro_data_types.dat` data file. You can add, edit, and remove user-defined attribute fields into which data is imported. Do not edit the key fields section of the file - it is not possible to add new key fields.

File location

The default data file is located in the `system` folder in the environment folder, for example, `C:\ProgramData\Trimble\Tekla Structures\<version>\environments\common\system`. There may also be a localized version of the file in the environment that you are using.

Do not make changes to the default files. Instead, create a copy of the file and store it in a different location, for example, in the firm folder or in the `attributes` folder in the model folder. This way, your changes are not overwritten when you reinstall or upgrade Tekla Structures. When the file

exists in multiple locations, the [default folder search order \(page 361\)](#) is followed and only the first file that is read is used.

File content

The `import_macro_data_types.dat` file is plain text. You can modify the file using any standard text editor, for example, Microsoft Notepad.

Each line in the file is a field definition that can contain the following attributes in this order:

User-defined attribute name, Data type, Conversion factor, Comments

1. User-defined attribute name. Write the internal field name as defined for the field in an `objects.inp` file.

For example, in the `objects.inp` definition

```
attribute("USER_FIELD_1", "j_user_field_1", string, "%s",  
no, none, "0.0", "0.0"),
```

the user-defined attribute name is `USER_FIELD_1`.

2. Data type.

The value can be: `INT` (integer), `STRING` (text), `FLOAT` (decimal number), or `DATE` (date fields with a calendar widget). If the value is missing or incorrect, the value defaults to `STRING`.

A value type mismatch does not prevent importing data, but the results may not always be correct depending on the data and the field. For example, date fields may be set incorrectly if the data type is not `DATE`. On the other hand, you can import a number with the integer data type into a text field without a problem.

Fields with option lists are defined as number fields of the `INT` value type. For example, object locks can be set to **No**, **Yes** and **Organization** with the corresponding numbers 0, 1 and 2 in the input file.

3. Conversion factor (optional, `FLOAT` only). For converting imperial values to metric values in imperial environments.

NOTE We recommend that you check the `FLOAT` values to avoid conversion factor errors.

4. Comment (optional). Any characters that follow the above definitions are ignored and can be used for writing your comments. However, these comments should be used sparingly as the file is easier to read if you write most comments on a separate line instead as explained below.

Tekla Structures treats lines starting with double forward slash characters (`//`) as comments and ignores them when reading the file.

Examples:

```
//Regular attributes
```

```
R1_ISSUED_FOR_APPRL, STRING
R1_DATE_APPROVED, DATE
```

```
//Attribute with conversion factor and comment
```

```
shear1, FLOAT, 4448.2222, For kips
```

10.3 Examples of input files

Example input file for parts

This input file is tab delimited.

ASSEMBLY_POS and PHASE are the key fields. Tekla Structures adds several user-defined attributes to the assemblies with values that match those listed in the ASSEMBLY_POS and PHASE columns.

For example, an assembly with the ASSEMBLY_POS (assembly number) of B5 in phase 1 gets the following user-defined attributes:

```
STATUS: 3
```

```
USER_PHASE: 6
```

```
USER_ISSUE: 3/25/2019
```

```
ASSEMBLY_POS  PHASE  STATUS  USER_PHASE  USER_ISSUE
B1  1  7  3  3/25/2019
B2  1  7  3  3/25/2019
B3  1  7  3  3/25/2019
B4  1  7  3  3/25/2019
B5  1  3  6  3/25/2019
B1  1  3  5  3/26/2019
B2  2  3  4  3/26/2019
```

The input file contains two entries for B1. In this case, Tekla Structures writes the message ">**Duplicate entry in input file.**" in the log file and only imports the first entry in the file. So in this example, B1 will have the following user-defined attributes after the attribute import:

```
STATUS: 7
```

```
USER_PHASE: 3
```

```
USER_ISSUE: 3/25/2019
```

Example input file for drawings

This input file is tab delimited.

TYPE and NAME are the key fields. Tekla Structures adds a value for the user-defined attribute User field 4 to drawings with values that match those listed in the TYPE and NAME columns.

For example, a drawing with the `TYPE A` (assembly drawing) and `NAME B.2` gets the value 4 in the `User field 4`.

```
TYPE NAME DRAWING_USERFIELD_4
A B.1 3
A B.2 4
A C.1 1
A C.2 2
```

10.4 Process an input file

NOTE This operation overwrites any existing attribute values for matching objects if the input file contains a value for the field.

By default, empty values are skipped. To clear existing values instead, set the advanced option `XS_ERASE_UDA_VALUE_WITH_ATTRIBUTE_IMPORT_NULL_AND_BLANK` to `TRUE` in an ini file.

1. If you want to import user-defined attributes to a selected area in the Tekla Structures model, select an area in the model.
2. On the **File** menu, click **Import --> Attributes** .
The **Import Attribute** dialog box opens.
3. Click the ... button next to the **Input file** box to select the input file to be imported. You can also enter the file path. The path length is 255 characters.
4. Choose the correct settings for the import.

Option	Description
Input file delimiters	Select a delimiter or several alternative delimiters used in the input file. You can delimit fields with any ASCII character that does not appear in the name or value of any of the attributes that you are importing.
Input scope	<ul style="list-style-type: none"> • Default, Entire model Tekla Structures assigns the user-defined attribute values of objects in the input file to matching objects in the model. • Selection only Tekla Structures only assigns the user-defined attribute values of objects in the input file to matching objects in the selected area of the model. <p>Use this option to import user-defined attributes to models. Do not use it for drawings.</p>

Option	Description
	<ul style="list-style-type: none"> • Reference models Tekla Structures assigns the user-defined attribute values of objects in the input file to matching objects in reference models.
Create log file	<ul style="list-style-type: none"> • Create Creates a new log file named <code>attribute_import.log</code> in the current model folder each time you import the user-defined attributes. Any previous attribute import log files are overwritten. • Append Adds log entries to the <code>attribute_import.log</code> file in the current model folder each time you import the user-defined attributes. If the log file does not exist, Tekla Structures creates it. • No Does not create a log file.
Display log file	<ul style="list-style-type: none"> • No The log file is not displayed. • On dialog The log file is displayed when the import is complete.

5. Click **Create** to import the file.

If you selected the option to display the log file, Tekla Structures displays the log file in a separate window, and you can click a log entry to select the corresponding object in the model.

11 Develop applications using Tekla Open API

You can develop your own applications and additional features for Tekla Structures through the Tekla Open API (Application Programming Interface). Tekla Open API is implemented using Microsoft .NET technology.

Applications that are developed using Tekla Open API to work with Tekla Structures are called *extensions*. To use the power of the Tekla Open API, you must write program code outside Tekla Structures. If you do not know how to program, you can still benefit from the Tekla Open API by downloading extensions created by others from [Tekla Warehouse](#).

With Tekla Open API you can:

- Record and run user interface actions
By recording and running user interface actions you can automate routine tasks, such as creating daily reports.
- Create automation tools
You can create automation tools for frequently needed objects. With automation tools you can, for example, create basic structures or add typical details to drawings.
- Integrate Tekla Structures to other software
You can utilize the Tekla Open API and .NET in transferring information between Tekla Structures and other software, such as Analysis & Design software.
- Create new functionality.

For more information on Tekla Open API and extensions, visit the [Tekla Developer Center](#).

12 Disclaimer

© 2022 Trimble Solutions Corporation and its licensors. All rights reserved.

This Software Manual has been developed for use with the referenced Software. Use of the Software, and use of this Software Manual are governed by a License Agreement. Among other provisions, the License Agreement sets certain warranties for the Software and this Manual, disclaims other warranties, limits recoverable damages, defines permitted uses of the Software, and determines whether you are an authorized user of the Software. All information set forth in this manual is provided with the warranty set forth in the License Agreement. Please refer to the License Agreement for important obligations and applicable limitations and restrictions on your rights. Trimble does not guarantee that the text is free of technical inaccuracies or typographical errors. Trimble reserves the right to make changes and additions to this manual due to changes in the software or otherwise.

In addition, this Software Manual is protected by copyright law and by international treaties. Unauthorized reproduction, display, modification, or distribution of this Manual, or any portion of it, may result in severe civil and criminal penalties, and will be prosecuted to the full extent permitted by law.

Tekla Structures, Tekla Model Sharing, Tekla PowerFab, Tekla Structural Designer, Tekla Tedds, Tekla Civil, Tekla Campus, Tekla Downloads, Tekla User Assistance, Tekla Discussion Forum, Tekla Warehouse and Tekla Developer Center are either registered trademarks or trademarks of Trimble Solutions Corporation in the European Union, the United States, and/or other countries. More about Trimble Solutions trademarks: <http://www.tekla.com/tekla-trademarks>. Trimble is a registered trademark or trademark of Trimble Inc. in the European Union, in the United States and/or other countries. More about Trimble trademarks: <http://www.trimble.com/trademarks.aspx>. Other product and company names mentioned in this Manual are or may be trademarks of their respective owners. By referring to a third-party product or brand, Trimble does not intend to suggest an affiliation with or endorsement by such third party and disclaims any such affiliation or endorsement, except where otherwise expressly stated.

Portions of this software:

EPM toolkit © 1995-2006 Jotne EPM Technology a.s., Oslo, Norway. All rights reserved.

Portions of this software make use of Open CASCADE Technology software. Open Cascade Express Mesh Copyright © 2019 OPEN CASCADE S.A.S. All rights reserved.

PolyBoolean C++ Library © 2001-2012 Complex A5 Co. Ltd. All rights reserved.

FLY SDK - CAD SDK © 2012 VisualIntegrity™. All rights reserved.

This application incorporates Open Design Alliance software pursuant to a license agreement with Open Design Alliance. Open Design Alliance Copyright © 2002-2020 by Open Design Alliance. All rights reserved.

CADhatch.com © 2017. All rights reserved.

FlexNet Publisher © 2016 Flexera Software LLC. All rights reserved.

This product contains proprietary and confidential technology, information and creative works owned by Flexera Software LLC and its licensors, if any. Any use, copying, publication, distribution, display, modification, or transmission of such technology in whole or in part in any form or by any means without the prior express written permission of Flexera Software LLC is strictly prohibited. Except where expressly provided by Flexera Software LLC in writing, possession of this technology shall not be construed to confer any license or rights under any Flexera Software LLC intellectual property rights, whether by estoppel, implication, or otherwise.

To see the third party open source software licenses, go to Tekla Structures, click **File menu** --> **Help** --> **About Tekla Structures** and then click the **3rd party licenses** option.

The elements of the software described in this Manual are protected by several patents and possibly pending patent applications in the United States and/or other countries. For more information go to page <http://www.tekla.com/tekla-patents>.

Index

A	
access rights	
configurations.....	76
example definitions.....	76
licenses.....	74
modifying.....	72,74
activating licenses	
troubleshooting.....	86
activating	
on-premises licenses.....	65
adding	
bolt assemblies to catalog.....	234
bolts to catalog.....	231
material grades.....	140
profiles.....	170
stud bolts to catalog.....	232
user attributes to material grades.....	143
user attributes to profiles.....	150
user-defined attributes to Template Editor.....	390
administrators	
advanced options.....	111
applications & components.....	257
bypassing.....	111
company.....	125
customizing.....	111
environment.....	125
environments.....	111
folders.....	111
help.....	9
INI files.....	111
initialization files.....	111
installation.....	11
licenses.....	111
licensing.....	11
multi-user.....	399
project.....	125
readme.....	9
registry keys.....	11
registry settings.....	11
roles.....	111
setting up.....	111
shortcuts.....	111
tekla model sharing.....	399
tekla user assistance.....	9
user-defined attributes.....	111
advanced options	
changing values.....	300
advanced options.....	271
storing settings.....	279
AIL files	
message files.....	317
API.....	411
applications and components	
adding instructor help.....	263
arcs	
sketching in sketch editor.....	184
assemblies	
bolt assemblies.....	229,234
bolt catalog.....	229
in templates.....	373
attributes	
in bending schedules.....	380
in templates.....	387
B	
before installing the on-premises license server.....	45
bending schedules.....	377
bending schedules	
attributes and values.....	380
bolt assemblies.....	234
bolt catalog.....	229
deleting.....	235
exporting.....	238
importing.....	237
modifying.....	235
properties.....	245
bolt assembly catalog.....	229,230
bolt assembly elements	

- bolt catalog..... 229
- bolt catalog..... 229,230
- bolts
 - adding bolt assemblies to catalog..... 234
 - adding to catalog.....231
 - bolt assemblies..... 229,235
 - bolt assembly catalog.....229,230
 - bolt catalog..... 229,230
 - creating studs..... 232
 - deleting from catalog.....234
 - exporting..... 235,237,240
 - importing..... 235,236,238,239
 - length calculation..... 240
 - modifying bolt information.....233
- borrowing licenses
 - troubleshooting..... 90
- borrowing
 - exporting product ID file..... 106
 - licenses..... 106
 - on-premises licenses..... 104,107
 - on-premises licenses..... 108
 - product ID file..... 106
 - product ID file..... 104

C

- calculating
 - bolt length.....240
- calculations.....394
- catalog files..... 321
- catalogs
 - bolt assembly catalog.....230,245
 - bolt catalog..... 230,243
 - creating..... 124
 - distributing..... 124
 - exporting material catalog..... 146
 - material catalog..... 139
 - profile catalog..... 147
- chamfers
 - in sketching.....198,201
- checking
 - sketched profiles..... 197
- circles
 - sketching in sketch editor..... 184
- clash check
 - settings in Options dialog box.....280
- CLB files.....173
- CNV files

- font conversion..... 324
- codes
 - configurations.....76
- coincident constraints..... 186
- comments
 - in templates.....392
- company.ini..... 271
- components.clb.....173
- components
 - settings in Options dialog box.....280
- compressing
 - shape geometry files..... 215
- configurations
 - codes.....76
- constraints
 - coincident.....186
 - deleting.....186
 - fixed..... 186
 - horizontal..... 186
 - in sketching..... 186
 - parallel.....186
 - perpendicular..... 186
 - vertical..... 186
- content types
 - rows..... 384
 - templates..... 384
- contentattributes.lst..... 390
- contentattributes_userdefined.lst..... 390
- converting
 - profiles.....170
- copying
 - material grades..... 141
 - profiles.....170
- creating
 - cross sections..... 164
 - customized initialization files.....21
 - HTML templates.....369
 - profiles..... 163,170,173,181
 - shapes from geometry.....217
 - shortcuts..... 21
 - sketched profiles..... 184
 - studs..... 232
 - templates..... 368
- cross sections
 - creating.....164
 - defining..... 164
 - modifying..... 164
 - profiles with variable cross sections..206

- user-defined..... 164
- custom tabs..... 134
- customized settings
 - creating.....124
 - distributing.....124
- customized initializations.....21
- customizing
 - administrators..... 111
 - message files..... 317
 - property pane settings..... 138
 - property pane layout..... 137
 - ribbons..... 132
 - tabs..... 134
 - toolbars..... 138
 - user-defined attributes..... 306

D

- DAT files..... 316
- data files.....316
- date
 - formats.....393,395
- deactivating licenses
 - troubleshooting..... 90
- deactivating
 - on-premises licenses..... 70
- decimals
 - settings in Options dialog box.....280
- defining
 - cross sections..... 164
 - flat bar sizes.....312
 - unfolding parameters.....313
- deleting
 - bolt assemblies.....235
 - bolts from catalog..... 234
 - material grades..... 142
 - profiles.....155
- dimensions
 - default format..... 280
 - default precision..... 280
 - default unit..... 280
 - in sketching.....189,201
 - settings..... 280
 - settings in Options dialog box.....280
- distributing
 - customized property pane settings.... 138
 - customized property pane layouts.... 137
 - customized ribbons..... 132

- customized tabs..... 134
- customized toolbars..... 138
- on-premises licenses..... 38
- drawing objects
 - settings in Options dialog box.....280
- drawing sheet numbers
 - templates.....393,395
- DWG files
 - symbols..... 325
- DWG profile to library (6)..... 164
- properties..... 164

E

- entitlement certificate
 - activating on-premises licenses..... 65
 - saving.....65
- EntitlementCertificate.html..... 65
- environment settings
 - global default276
 - local.....276
- environment variables.....271,279
 - changing values.....300
- environment.db..... 308
- environments
 - administrators..... 111
 - database file..... 308
- env_<environment>.ini.....271,276,299
- env_global_default.ini..... 271,299
- env_global_default.ini276
- examples
 - adding dimensions to sketched profile.... 201
 - adding user attributes to profiles..... 151
 - creating user-defined attribute..... 308
 - flat bar sizes.....312
 - modifying chamfers in sketched profile201
 - profile export file.....159
 - setting sketch thickness..... 201
 - sketching symmetric C-shaped profile.... 201
 - updating user-defined attribute.....308
 - using sketched profile in model..... 201
- exporting
 - bolt assemblies.....238
 - bolts..... 235,237,240
 - groups from shape catalog.....224

material grades.....	145,146,147
profiles.....	156,158,162,163
rebar definitions.....	250
reinforcement.....	250
shapes.....	224
sketched profiles.....	163
extensions	
Tekla Open API.....	411
extrusion types.....	198

F

file name extensions.....	336
file types	
catalog files.....	321
data files.....	316
font files.....	324
image files.....	326
initialization files.....	271
input files.....	302
layout definition files.....	325
log files.....	327
message files.....	317
profile files.....	321
property files.....	318
report files.....	325
shape definition files.....	210
standard files.....	319
symbol files.....	325
template files.....	325
files.....	265
extensions.....	336
in model folder.....	336
initialization files.....	271
locations.....	361
symbol.....	325
files related to	
environments.....	364
software.....	364
user settings.....	364
firewalls	
allowing traffic in TCP/IP ports.....	56
exceptions.....	54,55
lmgrd.exe.....	55
on-premises license server.....	54
tekla.exe.....	55
firm folders.....	266
fixed constraints.....	186

fixed profiles.....	170
flat bars	
in drawings	311
in reports.....	311
sizes.....	312
FlexNet.....	30
administrator's tasks.....	37
examples of different setups.....	40
IT resources.....	36
starting Tekla Structures.....	69
fltprops.inp.....	312
folders.....	265
administrators.....	111
in model folder.....	336
locations.....	361
search order.....	361
FON files	
fonts.....	324
font files.....	324
fonts.....	324
fonts_<lang>.ini.....	271
format functions	
templates.....	393,396
formats	
date in templates.....	393
formulas	
format functions.....	396
free attributes.....	380

G

global default environment settings.....	276
graphical templates	
creating.....	369
graphical templates	
pull-out pictures.....	377
grouping	
profiles.....	149,150
groups	
in rebar catalog.....	249
in shape catalog.....	218

H

handles	
of positioning planes.....	193
hidden files and folders	

- location.....364
- hiding
 - positioning planes.....193
- hierarchy
 - in templates.....392
- horizontal constraints.....186
- HTML templates
 - creating.....369
- HTML files
 - instructor.....263
- html.rpt extension.....369

I

- image files.....326
- images
 - file formats.....326
 - in templates.....381
 - of profile in profile catalog.....209
- imperial units
 - template value fields.....394
- imperial units
 - templates.....393
- import items.....212
- importing
 - bolt assemblies.....237
 - bolts.....235,236,238,239
 - groups to shape catalog.....212
 - material grades.....145
 - model.....402
 - profiles.....156,157,162
 - rebar definitions.....250
 - reinforcement.....250
 - shapes.....212
 - sketched profiles.....162
 - SketchUp.....214
 - user-defined attribute values.....404
- INI files.....271
 - env_<environment>.ini.....299
 - env_global_default.ini.....276,299
 - options.ini.....299
 - role_<role>.ini.....299
- INI files.....21,271
 - administrators.....111
 - options.ini.....279
 - role_<role>.ini.....277
 - user.ini.....277
- initialization files.....271

- administrators.....111
 - creating customized.....21
 - defining advanced options.....271
 - env_<environment>.ini.....276
 - env_global_default.ini.....276
 - file types.....271
 - reading order.....271
 - role_<role>.ini.....277
 - usage.....271
- INP files.....302,313
 - adding UDAs to Template Editor.....390
- input files.....302
- installation
 - on-premises license server.....47
- installing Tekla Structures
 - administrators.....11
- instructor
 - adding help for applications and components.....263

K

- keywords
 - in access right definitions.....76

L

- lang_<lang>.ini.....271
- LAY files
 - layout definitions.....325
 - layout definition files.....325
- length
 - bolt length calculation.....240
- LIC files
 - modifying.....51
- license servers
 - notifying automatically.....65
 - notifying manually.....65
- license servers
 - administrator's tasks.....37
- License Borrow Tool
 - returning licenses.....110
- License Borrow Tool
 - borrowing licenses.....108
- license files
 - modifying.....51
- license servers

- automatic installation..... 47
- configuring manually..... 52
- firewalls..... 54
- installing..... 45
- manual installation..... 48
- problems in installation.....82
- problems in server connection.....82
- version..... 46
- license service
 - installation.....47
 - manual installation..... 48
- licenses..... 40
 - access rights.....74
 - activating..... 65
 - administrator's tasks..... 37
 - administrators..... 111
 - allowing traffic through TCP/IP ports... 56
 - automatic installation of license server.... 47
 - borrowing..... 106,107,108
 - errors in activating..... 82
 - errors in borrowing.....82
 - errors in deactivating.....82
 - exceptions in firewall..... 55
 - installing license servers..... 45
 - IT resources needed..... 36
 - maintaining..... 72
 - managing.....29
 - modifying access rights..... 72,76
 - modifying license access rights..... 76
 - move between servers..... 79
 - on-premises..... 30
 - problems in activation.....86
 - problems in borrowing.....90
 - problems in deactivation.....90
 - problems in license server connection.82
 - problems in license server installation.82
 - product ID file..... 106
 - repairing..... 72,80
 - returning..... 110
 - troubleshooting Tekla licensing..... 81
 - trust status..... 80,91
 - what is provided by Trimble..... 35
- licensing applications
 - logging in as administrator..... 38
 - running as administrator..... 38
- licensing Tekla Structures
 - administrators..... 11

- lmgrd.exe..... 55
- LMTOOLS
 - configuring license server manually..... 52
 - monitoring license use..... 73
- load modeling
 - settings in Options dialog box.....280
- load defaults.....319
- local environment settings
 - env_<environment>.ini.....276
- locations
 - files.....361
 - folders..... 361
 - of hidden files.....364
- log files
 - list of..... 327
 - numberinghistory.txt log..... 333,335
 - session history.....332
 - viewing.....331
 - viewing parts or assemblies..... 331
- LST files
 - user-defined attributes..... 390

M

- manual installation
 - on-premises license server..... 48
- material catalog, see material grades..... 139
- material catalog
 - exporting..... 146
- material grades..... 139
 - adding.....140
 - adding user attributes..... 143
 - copying..... 141
 - deleting.....142
 - exporting..... 145,146,147
 - important buttons.....140
 - importing.....145
 - importing and exporting..... 160
 - material types.....139
 - modifying..... 142
 - saving changes..... 140
 - user-defined material symbols..... 144
- message files..... 317
 - customizing.....317
- Migration Wizard.....277
- model folder
 - file name extensions.....336
 - files.....336

model-specific settings.....	299
models	
importing.....	402
modifying	
bolt assembly information.....	235
bolt information.....	233
cross sections.....	164
license files.....	51
material grades.....	142
profile with variable cross sections....	206
profiles.....	170
rules.....	150
sketched profiles.....	198
mouse	
settings in Options dialog box.....	280
moving	
licenses.....	79

N

non-solid shapes	
importing.....	212
north marks	
settings in Options dialog box.....	280
notifying Tekla license server.....	65
numbering history.....	333,335
numbering	
settings in Options dialog box.....	280

O

objects.inp.....	303,390
offline use of Tekla Structures.....	107
on-premises license server.....	30
on-premises licenses	
borrowing.....	104
product ID file.....	104
on-premises licenses	
activating.....	65
deactivating.....	70
on-premises license servers	
firewalls.....	54
on-premises license service	
installation.....	47
on-premises license servers	
automatic installation.....	47
configuring manually.....	52

installing.....	45
manual installation.....	48
notifying automatically.....	65
notifying manually.....	65
problems in installation.....	82
problems in server connection.....	82
version.....	46
on-premises license service	
manual installation.....	48
on-premises licenses.....	30
automatic installation of license server....	47
borrowing.....	107,108
different ways of distributing.....	38
examples of different setups.....	40
installing license servers.....	45
number of users.....	40
problems in license server connection.....	82
problems in license server installation.....	82
OPT files	
on-premises licensing.....	38
OPT files	
standard.opt.....	279,280
Options dialog box	
settings.....	280
options file	
keywords for defining access rights.....	76
options.bin.....	271,279,299,300
options.ini.....	271,299
options	
saving.....	279
storing.....	279
options_drawings.db.....	279,280,299,300
options_model.db.....	279,280,299,300
orientation marks	
settings in Options dialog box.....	280

P

parallel constraints.....	186
parametric profiles.....	209
creating.....	181
parametric	
profiles.....	173
parts	
defining the material of profile types.....	154
PDF reports	
templates.....	371

- perpendicular constraints..... 186
- pictures
 - in templates..... 381
- plates
 - flat bars..... 311
- plotdev.bin..... 325
- polylines
 - sketching in sketch editor..... 184
- positioning planes..... 193
 - moving..... 193
 - reverting to default..... 193
- problems
 - in Tekla licensing..... 81
- product ID file (.tpi)..... 104
 - exporting..... 106
- profile catalog, see profiles..... 147
- Profile cross section from plate (10)..... 164
- profile files..... 321
- profiles
 - adding rules..... 149
 - adding user attributes..... 150
 - adding user attributes to profiles..... 151
 - associating with certain material..... 154
 - converting..... 170
 - copying..... 170
 - creating..... 163,170,173,181
 - creating image of profile..... 209
 - defining cross sections..... 164
 - deleting..... 155
 - exporting..... 156,158
 - fixed..... 170
 - grouping..... 149,150
 - importing..... 156,157
 - importing and exporting..... 160
 - modifying..... 170
 - parametric..... 173
 - profile catalog..... 147
 - Profile Editor..... 206
 - profile export file..... 159
 - rules..... 149
 - saving changes..... 148
 - sketching..... 181
 - user-defined..... 163
 - with variable cross sections..... 206
- profitab.inp..... 173
 - properties..... 173
- project folders..... 266
- properties

- bolt assembly catalog..... 245
- bolt catalog..... 243
- DWG profile to library (6)..... 164
- objects.inp..... 303
- Profile cross section from plate (10)... 164
- profitab.inp..... 173
- property files..... 318,319
- property pane settings
 - customizing..... 138
- property pane editor..... 137,138
- property pane layouts
 - customizing..... 137
- pull-out pictures
 - bending schedules..... 377

R

- reading order
 - initialization files..... 271
- reading order
 - folders..... 361
- rebar catalog..... 246
 - filtering..... 252
 - organizing..... 252
 - sorting..... 252
 - stars..... 252
 - tags..... 252
- rebar definitions
 - exporting..... 250
 - importing..... 250
- rebar catalog
 - definitions..... 247
 - groups..... 249
- rebar definitions..... 247
- reinforcement
 - exporting..... 250
 - importing..... 250
 - rebar catalog..... 246
- repairing licenses..... 72,80
- repairing subscriptions..... 72
- report files..... 325
- reports
 - date..... 393
 - tips..... 393
- returning
 - licenses..... 110
- reverting
 - to default positioning planes..... 193

- ribbon editor..... 132,134
- ribbons
 - customizing..... 132
- role settings..... 277
- roles..... 277
 - administrators..... 111
- role_<role>.ini..... 271,277,299
- rows
 - content types..... 384
- RPT files
 - report templates..... 325
 - textual templates..... 366
- rules
 - in profile catalog..... 149,150
 - profile catalog rules..... 149

S

- save and load properties..... 318
- save defaults..... 319
- saving
 - advanced options..... 279
 - options..... 279
 - profiles..... 148
 - sketched profiles..... 197
 - templates..... 368
- search order
 - folders..... 361
- session history..... 332
- setting up
 - administrators..... 111
- settings
 - bolt assembly catalog properties..... 245
 - bolt catalog properties..... 243
 - clash check..... 280
 - components..... 280
 - decimals..... 280
 - dimensions..... 280
 - drawing objects..... 280
 - general..... 280
 - general settings in Options dialo box. 280
 - in the Options dialog box..... 280
 - load modeling..... 280
 - mouse..... 280
 - north marks, see orientation marks... 280
 - orientation marks..... 280
 - startup..... 280
 - units..... 280

- shape catalog
 - importing shapes..... 212
- shape catalog
 - filtering..... 226
 - groups..... 218
 - organizing..... 226
 - sorting..... 226
 - stars..... 226
 - tags..... 226
- shape catalog..... 210,224
- shape cleaner..... 216
- shape definition files
 - shape catalog..... 210
- shapes
 - cleaning..... 216
 - compressing geometry files..... 215
 - creating..... 217
 - deleting..... 218
 - exporting..... 224
 - from geometry..... 217
 - grouping..... 218
 - importing..... 212
 - modifying properties..... 218
 - shape catalog..... 210
- shortcuts
 - creating..... 21
- showing
 - positioning planes..... 193
- Sketch Browser..... 181
- sketch editor..... 181
- sketched profiles..... 181
 - adding constraints..... 186
 - adding dimensions..... 189
 - arcs..... 184
 - chamfers..... 198
 - checking..... 197
 - circles..... 184
 - deleting constraints..... 186
 - deleting dimensions..... 189
 - example: adding dimensions..... 201
 - example: creating symmetric C-shaped profile..... 201
 - example: modifying chamfers..... 201
 - example: setting sketch thickness..... 201
 - example: using sketched profile in model..... 201
 - exporting..... 162,163
 - extrusion types..... 198

- importing..... 162
- modifying..... 198
- polylines..... 184
- positioning planes..... 193
- refining the shape..... 186
- saving..... 197
- setting the thickness..... 198
- sketch editor..... 181
- sketching the outline..... 184
- using in model..... 200
- sketching, see sketched profiles..... 181
- solid shapes
 - importing..... 212
- standard files
 - loading..... 319
 - saving..... 319
- standard files..... 318
- standard.opt..... 279,280
- standard.tpi..... 106
- standardized values
 - for parametric profiles..... 209
- starting
 - Tekla Structures with FlexNet licensing 69
- startup
 - settings in Options dialog box..... 280
- storing
 - advanced options..... 279
 - options..... 279
- studs..... 232
- subscriptions
 - maintaining..... 72
 - modifying access rights..... 72
 - repairing..... 72
- switch on-premises license servers..... 70
- SYM files
 - symbols..... 325
- symbol files..... 325
- system-specific settings..... 299

T

- tabs
 - importing customized tabs..... 134
- TCP/IP ports
 - allowing traffic..... 56
- Tekla License Borrow Tool
 - changing the language..... 107
 - downloading..... 107

- setting up for borrowing..... 107
- using..... 107
- Tekla License Borrow Tool
 - borrowing licenses..... 108
- Tekla license servers
 - problems in installation..... 82
 - problems in server connection..... 82
- Tekla Open API
 - extensions..... 411
- Tekla Structures files..... 265
- Tekla Structures folders..... 265
- tekla.exe..... 55
- tekla.lic
 - modifying manually..... 51
- tekla.opt..... 38,72,74,76
 - example definitions..... 76
- teklastructures.ini..... 271
- TeklaStructures_<user>.log..... 332
- template attributes..... 387
- Template Editor..... 366,368
- template files..... 325
- templates
 - adding images..... 381
 - aligning objects..... 373
 - attributes..... 387
 - bending schedules..... 377
 - comments..... 392
 - content types..... 384
 - creating..... 368,369
 - date..... 393
 - date formats..... 395
 - drawing sheet numbers..... 393,395
 - format functions..... 393
 - format functions..... 396
 - free attributes..... 377
 - graphical..... 366
 - graphical templates..... 369,377,381
 - headers and footers..... 369
 - headers and footers..... 373
 - hierarchy..... 392
 - imperial units..... 393
 - in HTML format..... 369
 - moving objects..... 373
 - of bending schedules..... 377,380
 - of nested assemblies..... 373
 - rows..... 384
 - saving..... 368
 - sorting order..... 373

textual.....	366
textual templates.....	373
tips.....	393
user-defined attributes.....	389,390,392
temporary licenses.....	108
testing	
sketched profiles.....	197
text type attributes	
in calculations.....	394
textual templates.....	373
TEZ files	
importing.....	212
TEZ files.....	215
shape catalog.....	210
thickness	
sketch thickness.....	198,201
tips	
templates and reports.....	393
toolbars	
customizing.....	138
TPI files	
license borrowing.....	106
product ID files.....	104
TPL files	
drawing templates.....	325
graphical templates.....	366
transfer licenses.....	79
transfer on-premises licenses.....	70
troubleshooting	
access rights.....	96
error codes	
Tekla licensing errors.....	97
error reports.....	82
license activation.....	82,86
license borrowing.....	82,90
license deactivation.....	82,90
license server connection.....	82
LMTOOLS.....	92
problems with FlexNet.....	85
starting Tekla Structures.....	94
Tekla licensing.....	97
Tekla license server installation.....	82
Tekla licensing.....	81
tekla.opt.....	96
trust status.....	91
trust status.....	80
trusted storage	
broken licenses.....	91

status.....	80
TTF files	
fonts.....	324

U

UDAs	
adding to Template Editor.....	390
importing values.....	404
unfolding parameters	
defining.....	313
unfold_corner_ratios.inp.....	313
units	
in importing and exporting.....	160
settings in Options dialog box.....	280
updating	
user-defined attributes in model.....	307
updating	
material catalog.....	140
profile catalog.....	148
user attributes	
adding to material grades.....	143
to profiles.....	150
user interface elements	
creating.....	124
distributing.....	124
user-defined attributes	
administrators.....	111
user-defined attributes	
importing.....	404
user-defined attributes	
customizing.....	306
environment.db.....	308
example.....	308
in templates.....	389,390,392
objects.inp properties.....	303
updating in model.....	307
user-defined material symbols	
creating.....	144
user-defined profiles.....	163
user-specific settings.....	299
user.ini.....	271
modifying.....	277

V

value fields	
--------------	--

format functions.....	396
value fields	
imperial units.....	394
variable cross sections.....	206
variables	
in sketching.....	181
vertical constraints.....	186
viewing parts or assemblies	
in log files.....	331
viewing	
log files.....	331
virtual use of Tekla Structures.....	25
virtualization.....	25

X

XML files	
instructor.....	263
message files.....	317
shape catalog.....	210
XML to TEZ.....	215
XS_FIRM	
fixed sub-folders.....	267
XS_PROJECT	
fixed sub-folders.....	267

